

**et al.**

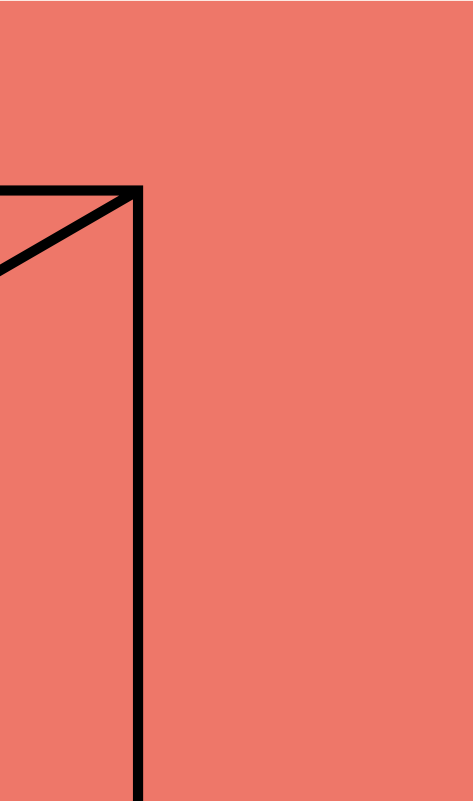

**et al.**

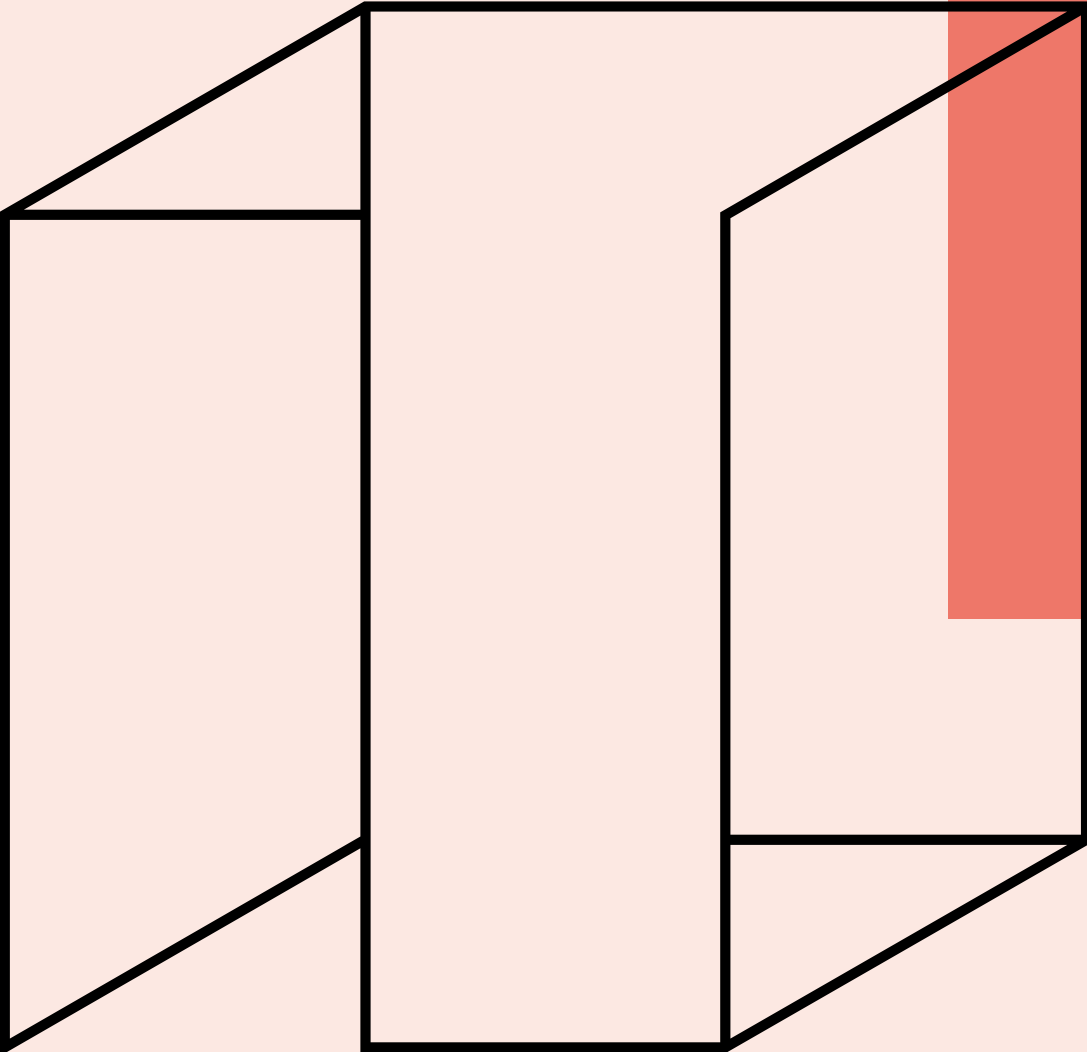

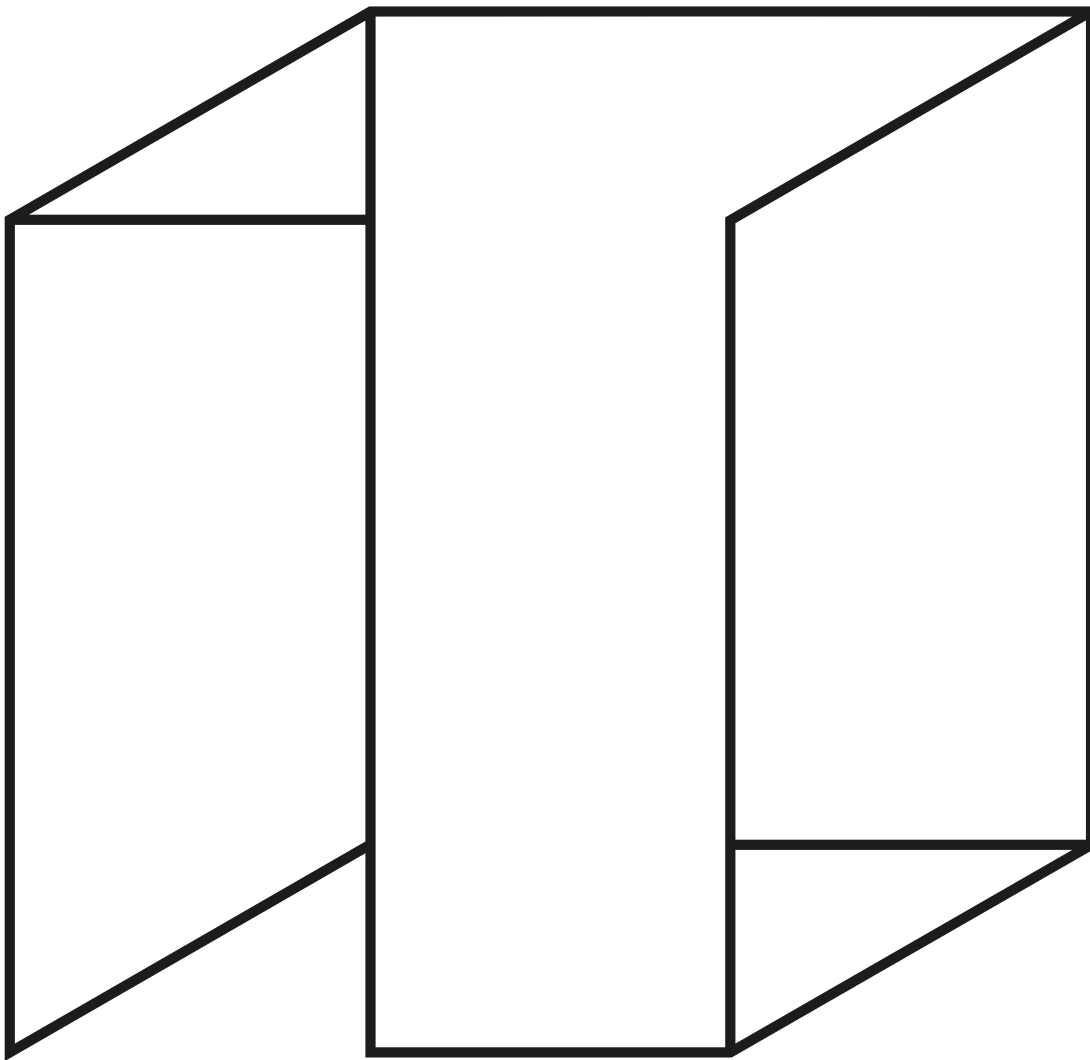
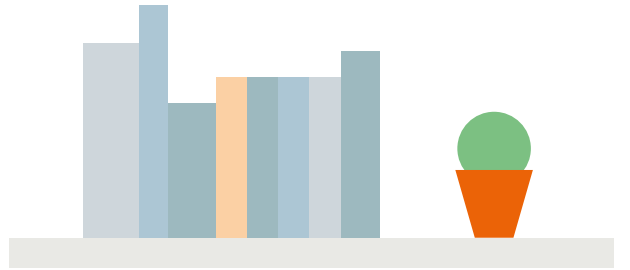
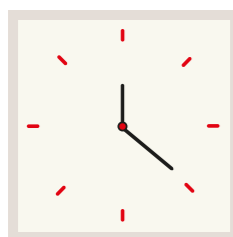
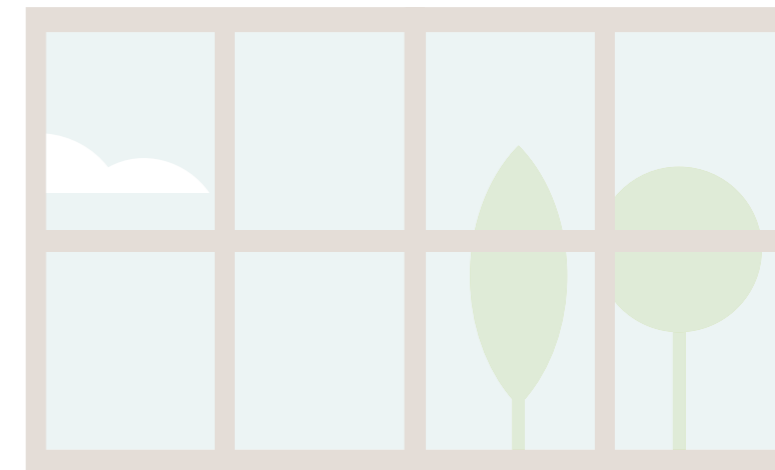
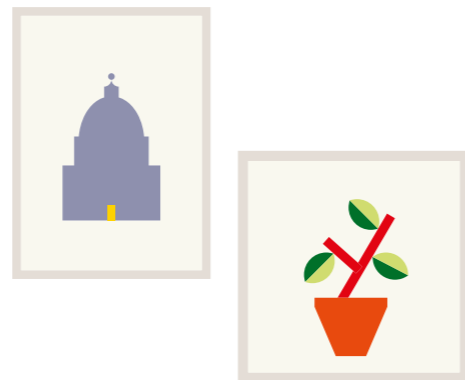

Nel 1956, le mani sapienti degli artigiani che intrecciavano il filo in plastica su telai di acciaio creavano una piccola icona delle sedute italiane, la poltroncina OO1. Era la nascita di Metalmobil e l'inizio di un percorso felice, guidato da uno sguardo verso il futuro che lentamente, giorno dopo giorno, diventava più chiaro, attraverso una visione sempre più affilata e a fuoco su un obiettivo: il design.

Oggi, quello che un tempo era un obiettivo è un presupposto: design come principio primo, motore di ogni pensiero e di ogni azione, scelta etica ed estetica, orizzonte che ha la sua forza vitale nell'ascolto degli altri. Per questo Metalmobil è diventata Et al.

In letteratura, Et al. significa "e altri" (dal latino et alii), in riferimento a tutti i co-autori di un'opera. Et al. è un ecosistema aperto, aggregante, che si arricchisce continuamente grazie alla partecipazione di progettisti affermati ed emergenti nello scenario internazionale. Et al. è il compimento di un percorso identitario che desidera portare nel futuro le radici di un territorio unico al mondo, tra la Romagna e le Marche, dove mare e colline si incontrano, e dove saper fare artigiano e cultura industriale si fondono, per migliorare la qualità della vita delle persone.

Il punto finale di Et al. altro non è che l'inizio di nuove esperienze.

In 1956 the skilful hands of the craftsmen who wove plastic wire onto steel frames created an iconic little Italian seat, the OO1 armchair. This was the birth of Metalmobil and the start of a successful journey, guided with an eye to the future that slowly, day by day, became clearer and with a vision that became sharper and sharper and focused on one objective: design.

Today, what was once an objective is now a prerequisite: design is our guiding principle, which drives every thought and every action, an ethical and aesthetic choice, an horizon whose vitality lies in listening to others. This is why Metalmobil is now Et al.

In literature Et al means "and others" (from the Latin et alii), referring to all the co-authors of a work. Et al. is an open ecosystem, which brings people together and is continually enriched by the involvement of recognised and emerging designers on the international stage.

Et al. is the fulfilment of a journey to discover its identity and that wishes to carry into the future the roots of a unique territory, between Romagna and Marche, where sea and hills meet and where craftsmanship and industrial culture come together to improve the quality of life.

The ending point of Et al. is nothing else but the beginning of new experiences.

En 1956, les mains habiles des artisans qui ont entrelacé le fil de plastique sur des cadres en acier ont créé une petite icône des sièges italiens, le fauteuil OO1. C'était la naissance de Metalmobil et le début d'un parcours heureux, guidé par un objectif qui s'est clarifié avec les années: le design.

Aujourd'hui, ce qui était autrefois un objectif est un préalable: le design comme principe premier, le moteur de chaque pensée et de chaque action, un choix éthique et esthétique, un horizon de pensée qui puise sa force vitale à l'écoute des autres. C'est pour cela que Metalmobil est devenu Et al.

Dans la littérature, Et al. signifie «et autres» (du latin et alii), se référant à tous les co-auteurs d'une œuvre. Et al. est un écosystème ouvert et fédérateur qui s'enrichit en permanence de la participation de designers établis et émergents sur la scène internationale. Et al. est l'accomplissement d'un chemin identitaire qui souhaite projeter dans le futur les racines d'un territoire unique au monde, entre la Romagna et les Marches, où se rencontrent mer et collines, et où l'artisanat et la culture industrielle se mélangent, pour améliorer la qualité de vie des personnes.

Le point final de Et al. est le début de nouvelles expériences.

Im Jahr 1956 schufen die geschickten Hände der Handwerker, die Kunststoffdraht auf Stahlrahmen webten, eine kleine Ikone des italienischen Sitzens, den OO1 Sessel. Es war die Geburtsstunde von Metalmobil und der Beginn einer glücklichen Reise, geleitet von einem Blick in die Zukunft, der langsam, Tag für Tag, klarer wurde, durch eine Vision, die immer schärfer und auf ein Ziel ausgerichtet war: Design.

Was früher ein Ziel war, ist heute eine Selbstverständlichkeit: Design als erstes Prinzip, die treibende Kraft hinter jedem Denken und Handeln, eine ethische und ästhetische Entscheidung, ein Denkhorizont, der seine Lebenskraft im Zuhören hat. Aus diesem Grund hat sich Metalmobil zu Et al gewandelt.

In der Literatur bedeutet Et al. "und andere" (vom lateinischen et alii) und bezieht sich auf alle Mitautoren (oder: alle Kreativen/alle kreativen Köpfe) eines Werkes. Et al. ist ein offenes, aggregierendes Ökosystem, das durch die Teilnahme von etablierten und aufstrebenden Designern der internationalen Szene kontinuierlich bereichert wird. Et al. ist die Erfüllung eines Identitätsweges, der die Wurzeln eines in der Welt einzigartigen Territoriums zwischen Romagna und Marken hat. Hier treffen sich Meer und Hügel, Handwerk und Industriekultur kommen zusammen, will in die Zukunft bringen, um die Lebensqualität der Menschen zu verbessern und bereichern.

Der Endpunkt von Et al. ist nur der Anfang von neuen Erfahrungen.

En 1956 las expertas manos de los artesanos que trenzaban un hilo de plástico en bastidores de acero creaban un icono del asiento italiano, el sillón OO1. Era el nacimiento de Metalmobil y el principio de una andadura feliz, guiada por una mirada hacia el futuro que lentamente, día tras día, se afianzaba a través de una visión cada vez más clara y enfocada en un objetivo: el diseño.

Hoy, lo que antaño era un objetivo, se ha convertido en un presupuesto: diseño como principio primordial, motor de todo pensamiento y de toda acción, elección ética y estética, horizonte con fuerza vital en escuchar a los demás. Por esto Metalmobil se ha convertido en Et al.

En la literatura Et al. significa "y otros" (del latín et alii), para indicar a todos los coautores de una obra. Et al. es un ecosistema abierto, aglutinador, que se enriquece continuamente gracias a la participación de diseñadores renombrados y emergentes del escenario internacional. Et al. es cumplimiento de un recorrido identitario que desea conducir hacia el futuro las raíces de un territorio único en el mundo ubicado entre Romaña y Las Marcas, allí donde el mar y las montañas se encuentran y donde el saber artesanal y la cultura industrial se funden para mejorar la calidad de vida de las personas.

El punto final de Et al. no es más que el comienzo de nuevas experiencias.



8 **classy**  
design  
Luca Nichetto



22 **snap**  
design  
Francesco Meda

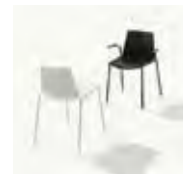

34 **cuba**  
design  
Marc Sadler



44 **main**  
design  
Lorenzo Damiani



48 **ambit**  
design  
Giovanni Levanti



60 **pillow**  
design  
Andrea Anastasio



68 **hull**  
design  
Harri Koskinen



78 **shade**  
design  
Philippe Nigro



90 **palau**  
design  
Marc Sadler



98 **myra**  
design  
Emilio Nanni



118 **nassau**  
design  
Marc Sadler



126 **pif**  
design  
Marc Sadler



128 **dalton**  
design  
Giulio Iacchetti

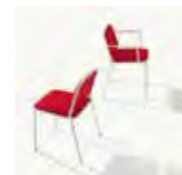

136 **ring**  
design  
Radice Orlandini Design Studio



142 **nomad**  
design  
rdm



148 **flint**  
design  
Marc Sadler



150 **stripes**  
design  
Talocci Design



154 **play**  
design  
Radice Orlandini Design Studio



158 **to-kyo**  
design  
Makio Hasuike & Co.



164 **marè**  
design  
Marc Sadler



170 **kontea**  
design  
Carlo Bimbi Design



174 **kyk**  
design  
Carlo Bimbi Design



178 **uni-ka**  
design  
rdm



192 **uni**  
design  
Francesco Geraci



212 **abaco+**  
design  
rdm



216 **playa**  
design  
Carlo Bimbi Design



220 **zero**  
design  
Carlo Bimbi Design



224 **marka**  
design  
Carlo Bimbi Design

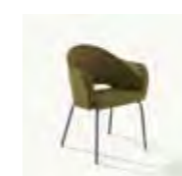

228 **agatha**  
design  
rdm



232 **duo**  
design  
Franco Bertoli & Max Pajetta



234 **punto**  
design  
Francesco Geraci



238 **abaco**  
design  
rdm



244 **echo**  
design  
rdm



250 **kicca**  
design  
Francesco Geraci



254 **net**  
design  
Francesco Geraci



256 **apple**  
design  
Egidio Panzera



258 **luna**  
design  
rdm



262 **ibis**  
design  
Francesco Geraci



268 **boom**  
design  
Emilio Nanni



270 **space**  
design  
rdm





278 **001**  
design  
rdm



280 **harvey**  
design  
Francesco Faccin

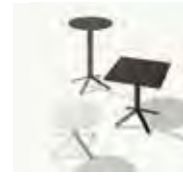

288 **milos**  
design  
Marc Sadler



298 **noodle**  
design  
Ana Kraš



304 **salinero**  
design  
Giulio Iacchetti



310 **dalton**  
design  
Giulio Iacchetti



320 **jet**  
design  
rdm



326 **ex**  
design  
rdm



328 **ax**  
design  
rdm



332 **deck**  
design  
rdm



336 **web**  
design  
rdm



340 **zenith**  
design  
rdm



342 **mt**  
design  
rdm

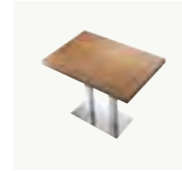

350 **xt**  
design  
rdm

elenco alfabetico / alphabetical list /  
liste alphabétique / alphabetische  
liste / lista alfabética

**O**

001 278

**a**

abaco 238  
abaco+ 212  
agatha 228  
ambit 48  
apple 256  
ax 328

**b**

boom 268

**c**

classy 08  
cuba 34

**d**

dalton 128  
dalton 310  
deck 332  
duo 232

**e**

echo 244  
ex 326

**f**

flint 148

**h**

harvey 280  
hull 68

**i**

ibis 262

**j**

jet 320

**k**

kicca 250  
kontea 170  
kyk 174

**l**

luna 258

**m**

main 44  
maré 164  
marka 224  
milos 288  
mt 342  
myra 98

**n**

nassau 118  
net 254  
nomad 142  
noodle 298

**p**

palau 90  
pif 126  
pillow 60  
play 154  
playa 216  
punto 234

**r**

ring 136

**s**

salinero 304  
shade 78  
snap 22  
space 270  
stripes 150

**t**

to-kyo 158

**u**

uni 192  
uni-ka 178

**w**

web 336

**x**

xt 350

**z**

zenith 340  
zero 220

# classy

design  
**Luca Nichetto**









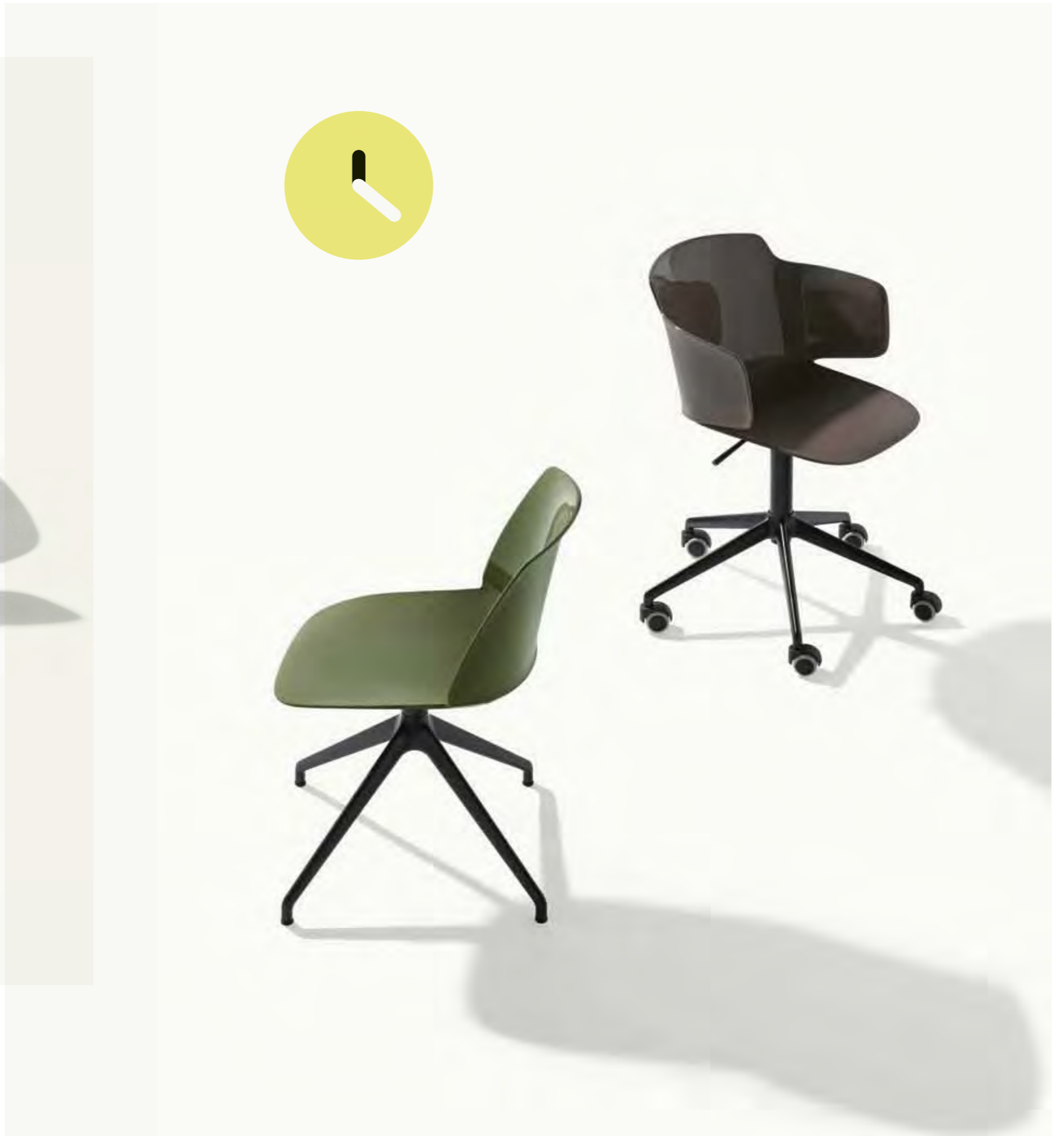





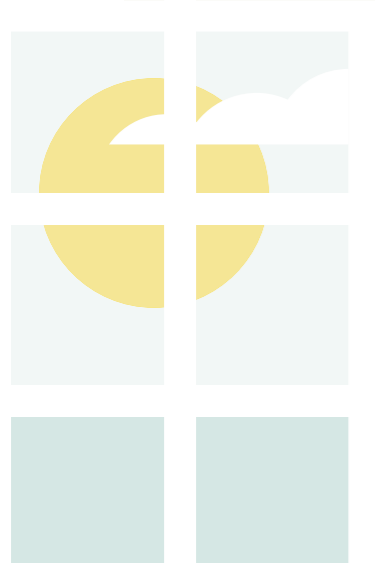

**optional:**  
piedino orientabile /  
tilt glides /  
patins pivotants /  
verstellbare Füße /  
pie ajustable



## 1090

- > Sedia con telaio a 4 gambe in tubo acciaio. Seduta in polipropilene.
- > Chair with steel frame, 4 legs. Polypropylene shell.
- > Chaise avec châssis en acier 4 pieds et coque en polypropylène.
- > Stuhl mit 4-beinigem Stahlgestell. Sitzfläche aus Polypropylen.
- > Silla 4 patas en tubo de acero. Carcasa en polipropileno.

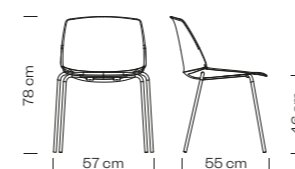

Peso / Weight / Poids / Gewicht / Peso **5,1 kg**

Imballo / Packaging / Emballage / Verpackung / Embalaje **0,39 m<sup>3</sup>**

Pezzi per scatola / Pieces for box / Pièces par carton / Stücke in einem Karton / Piezas por caja **4**

Impilabile / Stackable / Empilable / Stapelbar / Apilable **10**



## 1091

- > Poltroncina con telaio a 4 gambe in tubo acciaio, seduta in polipropilene.
- > Armchair with steel frame, 4 legs. Polypropylene shell.
- > Fauteuil avec châssis en acier 4 pieds et coque en polypropylène.
- > Armlehnstuhl mit 4-beinigem Stahlgestell. Sitzfläche aus Polypropylen.
- > Sillón 4 patas en tubo de acero. Carcasa en polipropileno.

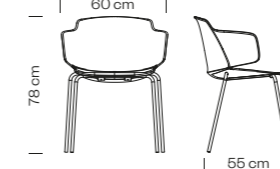

Peso / Weight / Poids / Gewicht / Peso **5,5 kg**

Imballo / Packaging / Emballage / Verpackung / Embalaje **0,49 m<sup>3</sup>**

Pezzi per scatola / Pieces for box / Pièces par carton / Stücke in einem Karton / Piezas por caja **4**

Impilabile / Stackable / Empilable / Stapelbar / Apilable **4**



## 1092

- > Sgabello con telaio a 4 gambe in tubo acciaio. Seduta in polipropilene.
- > Barstool with steel frame, 4 legs. Polypropylene shell.
- > Tabouret avec châssis en acier 4 pieds et coque en polypropylène.
- > Barhocker mit 4-beinigem Stahlgestell. Sitzfläche aus Polypropylen.
- > Taburete 4 patas en tubo de acero. Carcasa en polipropileno.

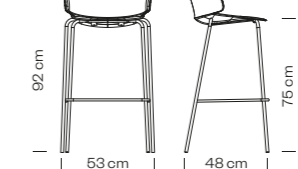

Peso / Weight / Poids / Gewicht / Peso **5,9 kg**

Imballo / Packaging / Emballage / Verpackung / Embalaje **0,44 m<sup>3</sup>**

Pezzi per scatola / Pieces for box / Pièces par carton / Stücke in einem Karton / Piezas por caja **4**

Impilabile / Stackable / Empilable / Stapelbar / Apilable **4**



## 1092B

- > Sgabello con telaio a 4 gambe in tubo acciaio. Seduta in polipropilene. H 65 cm.
- > Barstool with steel frame, 4 legs. Polypropylene shell. H 65 cm.
- > Tabouret avec châssis en acier 4 pieds et coque en polypropylène. H 65 cm.
- > Barhocker mit 4-beinigem Stahlgestell. Sitzfläche aus Polypropylen. H 65 cm.
- > Taburete con estructura tubular 4 patas en acero, carcasa en polipropileno. H 65 cm.

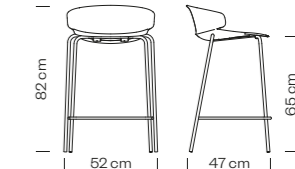

Peso / Weight / Poids / Gewicht / Peso **5,8 kg**

Imballo / Packaging / Emballage / Verpackung / Embalaje **0,40 m<sup>3</sup>**

Pezzi per scatola / Pieces for box / Pièces par carton / Stücke in einem Karton / Piezas por caja **4**

Impilabile / Stackable / Empilable / Stapelbar / Apilable **4**





## 1095

- > Sedia con telaio 4 gambe in frassino. Seduta in polipropilene.
- > Chair with ash wood frame, 4 legs. Polypropylene shell.
- > Chaise châssis 4 pieds en frêne et coque en polypropylène.
- > Stuhl mit Gestell aus 4-beinigem aus Eschenholz. Sitzfläche aus Polypropylen.
- > Silla 4 patas con estructura en fresno. Carcasa en polipropileno.

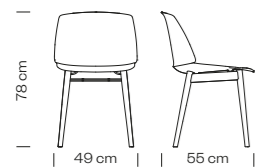

Peso / Weight / Poids / Gewicht / Peso **4,8 Kg**

Imballo / Packaging / Emballage / Verpackung / Embalaje **0,32 m<sup>3</sup>**

Pezzi per scatola / Pieces for box / Pièces par carton / Stücke in einem Karton / Piezas por caja **1**



## 1096

- > Poltroncina con telaio 4 gambe in frassino, seduta in polipropilene.
- > Armchair with ash wood frame, 4 legs. Polypropylene shell.
- > Fauteuil avec châssis 4 pieds en frêne et coque en polypropylène.
- > Armlehnstuhl, Gestell aus 4-beinigem aus Eschenholz. Sitzfläche aus Polypropylen.
- > Sillón 4 patas con estructura en fresno, carcasa en polipropileno.

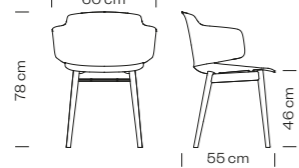

Peso / Weight / Poids / Gewicht / Peso **5,4 Kg**

Imballo / Packaging / Emballage / Verpackung / Embalaje **0,32 m<sup>3</sup>**

Pezzi per scatola / Pieces for box / Pièces par carton / Stücke in einem Karton / Piezas por caja **1**



## 1086

- > Sedia girevole, telaio 4 razze in fusione alluminio, seduta in polipropilene.
- > Swivel side chair with 4-star die cast aluminium frame, polypropylene shell.
- > Chaise pivotante, châssis 4 branches en fonte d'aluminium, coque en polypropylène.
- > Drehbarer Stuhl mit 4-Sterne-Gestell aus Aluminiumguss, Schale aus Polypropylen.
- > Silla giratoria con base 4 radios en aluminio, carcasa en polipropileno.

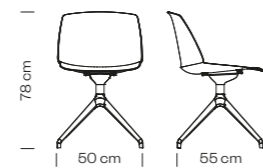

Peso / Weight / Poids / Gewicht / Peso **7 kg**

Imballo / Packaging / Emballage / Verpackung / Embalaje **0,38 m<sup>3</sup>**

Pezzi per scatola / Pieces for box / Pièces par carton / Stücke in einem Karton / Piezas por caja **1**



## 1087

- > Poltroncina girevole, telaio 4 razze in fusione alluminio, seduta in polipropilene.
- > Swivel armchair with 4-star die cast aluminium frame. Polypropylene shell.
- > Chaise pivotante avec accoudoirs, châssis 4 branches en fonte d'aluminium, coque en polypropylène.
- > Drehbarer Armlehnstuhl mit 4-Sterne-Gestell aus Aluminiumguss, Schale aus Polypropylen.
- > Sillón giratorio con base 4 radios en aluminio, carcasa en polipropileno

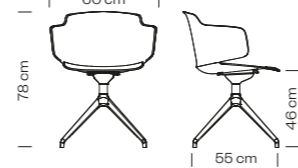

Peso / Weight / Poids / Gewicht / Peso **7,4 kg**

Imballo / Packaging / Emballage / Verpackung / Embalaje **0,38 m<sup>3</sup>**

Pezzi per scatola / Pieces for box / Pièces par carton / Stücke in einem Karton / Piezas por caja **1**



## 1088

- > Sedia, telaio 5 razze in fusione alluminio, su ruote, sedia girevole, regolabile in altezza.
- > Swivel side chair with 5-star die cast aluminium frame on castors, polypropylene shell, adjustable seat height.
- > Chaise pivotante, châssis 5 branches en fonte d'aluminium avec roulettes, coque en polypropylène, réglable en hauteur.
- > Drehbarer Stuhl mit 5-Sterne-Aluminiumgussrahmen und Rollen, Schale aus Polypropylen, Höhenverstellbar/Altura.
- > Silla giratoria base 5 radios en aluminio con ruedas, carcasa en polipropileno, asiento regulable.

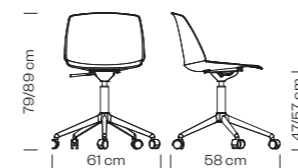

Peso / Weight / Poids / Gewicht / Peso **8,8 kg**

Imballo / Packaging / Emballage / Verpackung / Embalaje **0,50 m<sup>3</sup>**

Pezzi per scatola / Pieces for box / Pièces par carton / Stücke in einem Karton / Piezas por caja **1**



## 1089

- > Poltroncina girevole, telaio 5 razze in fusione alluminio, su ruote, seduta in polipropilene, regolabile in altezza.
- > Swivel armchair with 5-star die cast aluminium frame on castors, polypropylene shel, adjustable seat height.
- > Chaise pivotante avec accoudoirs, châssis 5 branches en fonte d'aluminium avec roulettes, coque en polypropylène, réglable en hauteur.
- > Drehbarer Armlehnstuhl mit 5-Sterne-Aluminiumgussrahmen und Rollen, Schale aus Polypropylen, Höhenverstellbar.
- > Sillón giratorio base 5 radios en aluminio con ruedas, carcasa en polipropileno, Altura asiento regulable.



Peso / Weight / Poids / Gewicht / Peso **9,3 kg**

Imballo / Packaging / Emballage / Verpackung / Embalaje **0,50 m<sup>3</sup>**

Pezzi per scatola / Pieces for box / Pièces par carton / Stücke in einem Karton / Piezas por caja **1**

## PP

- > Finiture seduta
- > Seat finishes
- > Finitions de l'assise
- > Sitzfertigungen
- > Acabados asiento



## LE

- > Finiture telaio
- > Frame finishes
- > Finitions piètement
- > Gestell Fertigungen
- > Acabados estructura



## AC

- > Finiture telaio (vedi p. 397)
- > Frame finishes (see p. 397)
- > Finitions piètement (voir p. 397)
- > Gestell Fertigungen (sehen S. 397)
- > Acabados estructura (ver p. 397)

## AL PSH

- > Finiture telaio (vedi p. 399)
- > Frame finishes (see p. 399)
- > Finitions piètement (voir p. 399)
- > Gestell Fertigungen (sehen S. 399)
- > Acabados estructura (ver p. 399)

## AL VR

- > Finiture telaio (vedi p. 400)
- > Frame finishes (see p. 400)
- > Finitions piètement (voir p. 400)
- > Gestell Fertigungen (sehen S. 400)
- > Acabados estructura (ver p. 400)



# snap

design  
Francesco Meda

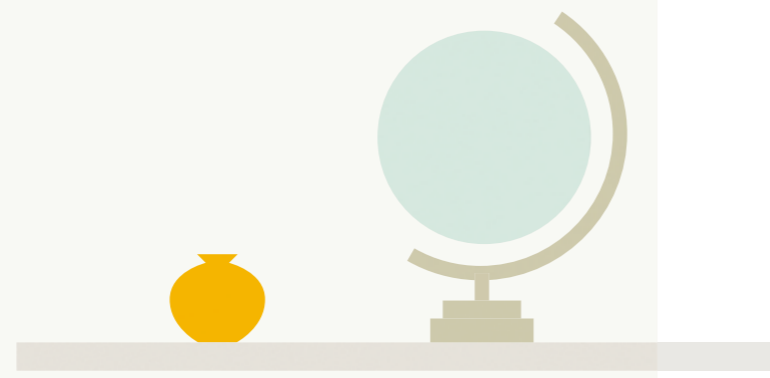







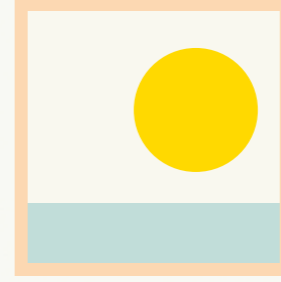
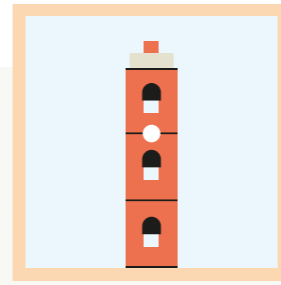
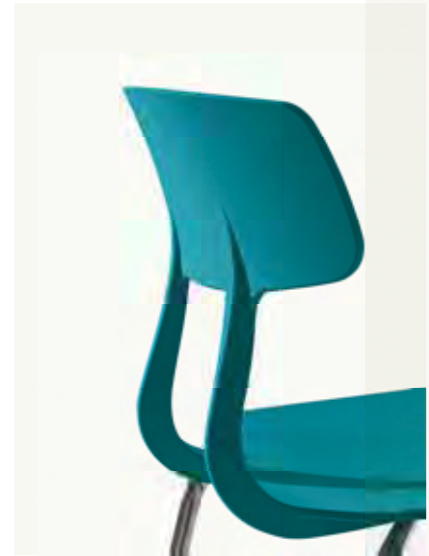



## PP

- > Finiture seduta
- > Seat finishes
- > Finitions de l'assise
- > Sitzfertigungen
- > Acabados asiento

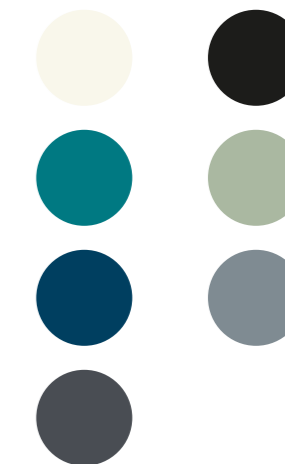

## AC

- > Finiture telaio (vedi p. 397)
- > Frame finishes (see p. 397)
- > Finitions piètement (voir p. 397)
- > Gestell Fertigungen (sehen S. 397)
- > Acabados estructura (ver p. 397)

## AL PSH

- > Finiture telaio (vedi p. 399)
- > Frame finishes (see p. 399)
- > Finitions piètement (voir p. 399)
- > Gestell Fertigungen (sehen S. 399)
- > Acabados estructura (ver p. 399)

## AL VR

- > Finiture telaio (vedi p. 400)
- > Frame finishes (see p. 400)
- > Finitions piètement (voir p. 400)
- > Gestell Fertigungen (sehen S. 400)
- > Acabados estructura (ver p. 400)







## 1100

- > Sedia con telaio a 4 gambe in tubo acciaio. Seduta in polipropilene.
- > Chair with steel frame, 4 legs. Polypropylene shell.
- > Chaise avec châssis en acier 4 pieds et coque en polypropylène.
- > Stuhl mit 4-beinigem Stahlgestell. Sitzfläche aus Polypropylen.
- > Silla 4 patas en tubo de acero. Carcasa en polipropileno.

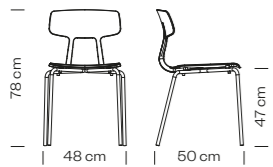

Peso / Weight / Poids / Gewicht / Peso **4,1 kg**

Imballo / Packaging / Emballage / Verpackung / Embalaje **0,39 m³**

Pezzi per scatola / Pieces for box / Pièces par carton / Stücke in einem Karton / Piezas por caja **4**

Impilabile / Stackable / Empilable / Stapelbar / Apilable **10**



## 1101

- > Sedia con telaio a 4 gambe in tubo acciaio, con braccioli. Seduta in polipropilene.
- > Armchair with steel frame and steel frame, 4 legs. Polypropylene shell.
- > Chaise avec châssis en acier 4 pieds et accoudoirs. Coque en polypropylène.
- > Armlehnstuhl mit 4-beinigem Stahlgestell. Sitzfläche aus Polypropylen.
- > Sillón 4 patas en tubo de acero. Carcasa en polipropileno.

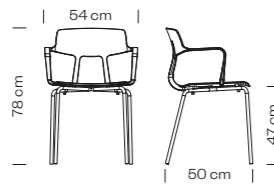

Peso / Weight / Poids / Gewicht / Peso **4,4 kg**

Imballo / Packaging / Emballage / Verpackung / Embalaje **0,39 m³**

Pezzi per scatola / Pieces for box / Pièces par carton / Stücke in einem Karton / Piezas por caja **4**

Impilabile / Stackable / Empilable / Stapelbar / Apilable **5**



## 1102

- > Sgabello con telaio a 4 gambe in tubo acciaio. Seduta in polipropilene.
- > Barstool with steel frame, 4 legs. Polypropylene shell.
- > Tabouret avec châssis en acier 4 pieds et coque en polypropylène.
- > Barhocker mit 4-beinigem Stahlgestell. Sitzfläche aus Polypropylen.
- > Taburete 4 patas en tubo de acero. Carcasa en polipropileno.

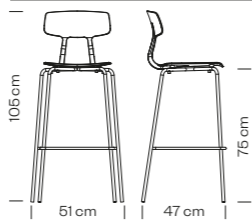

Peso / Weight / Poids / Gewicht / Peso **5,3 kg**

Imballo / Packaging / Emballage / Verpackung / Embalaje **0,48 m³**

Pezzi per scatola / Pieces for box / Pièces par carton / Stücke in einem Karton / Piezas por caja **4**

Impilabile / Stackable / Empilable / Stapelbar / Apilable **4**



## 1102B

- > Sgabello con telaio a 4 gambe in tubo acciaio. Seduta in polipropilene. H 65 cm.
- > Barstool with steel frame, 4 legs. Polypropylene shell. H 65 cm.
- > Tabouret avec châssis en acier 4 pieds et coque en polypropylène. H 65 cm.
- > Barhocker mit 4-beinigem Stahlgestell. Sitzfläche aus Polypropylen. H 65 cm.
- > Taburete con estructura tubular 4 patas en acero, carcasa en polipropileno. H 65 cm.

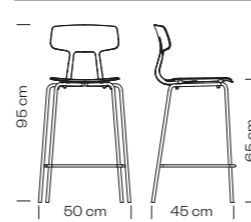

Peso / Weight / Poids / Gewicht / Peso **5,2 kg**

Imballo / Packaging / Emballage / Verpackung / Embalaje **0,38 m³**

Pezzi per scatola / Pieces for box / Pièces par carton / Stücke in einem Karton / Piezas por caja **4**

Impilabile / Stackable / Empilable / Stapelbar / Apilable **4**



## 1108

- > Sedia girevole, telaio 4 razze in fusione alluminio, seduta in polipropilene.
- > Swivel side chair with 4-star die cast aluminium frame, polypropylene shell.
- > Chaise pivotante, châssis 4 branches en fonte d'aluminium, coque en polypropylène.
- > Drehbarer Stuhl mit 4-Sterne-Gestell aus Aluminiumguss, Schale aus Polypropylen.
- > Silla giratoria con base 4 radios en aluminio, carcasa en polipropileno.

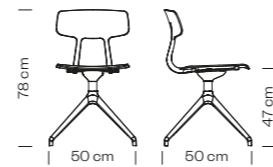

Peso / Weight / Poids / Gewicht / Peso **6,1 kg**

Imballo / Packaging / Emballage / Verpackung / Embalaje **0,50 m³**

Pezzi per scatola / Pieces for box / Pièces par carton / Stücke in einem Karton / Piezas por caja **2**

Impilabile / Stackable / Empilable / Stapelbar / Apilable **4**



## 1109

- > Poltroncina girevole, telaio 4 razze in fusione alluminio, seduta in polipropilene.
- > Swivel armchair with 4-star die cast aluminium frame, polypropylene shell.
- > Chaise pivotante avec accoudoirs, châssis 4 branches en fonte d'aluminium, coque en polypropylène.
- > Drehbarer Armlehnstuhl mit 4-Sterne-Gestell aus Aluminiumguss, Schale aus Polypropylen.
- > Sillón giratorio con base 4 radios en aluminio, carcasa en polipropileno.

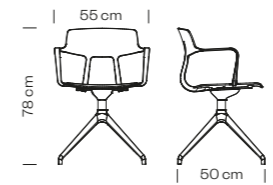

Peso / Weight / Poids / Gewicht / Peso **6,4 kg**

Imballo / Packaging / Emballage / Verpackung / Embalaje **0,38 m³**

Pezzi per scatola / Pieces for box / Pièces par carton / Stücke in einem Karton / Piezas por caja **1**

Impilabile / Stackable / Empilable / Stapelbar / Apilable **1**



## 1110

- > Sedia girevole, telaio 5 razze in fusione alluminio, su ruote, seduta in polipropilene, regolabile in altezza.
- > Swivel side chair with 5-star die cast aluminium frame on castors, polypropylene shell, adjustable seat height.
- > Chaise pivotante, châssis 5 branches en fonte d'aluminium avec roulettes, coque en polypropylène, réglable en hauteur.
- > Drehbarer Stuhl mit 5-Sterne-Aluminiumgussrahmen und Rollen, Schale aus Polypropylen, Höhenverstellbar.
- > Silla giratoria base 5 radios en aluminio con ruedas, carcasa en polipropileno, altura asiento regulable.

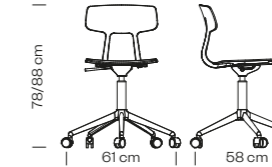

Peso / Weight / Poids / Gewicht / Peso **8 kg**

Imballo / Packaging / Emballage / Verpackung / Embalaje **0,50 m³**

Pezzi per scatola / Pieces for box / Pièces par carton / Stücke in einem Karton / Piezas por caja **1**

Impilabile / Stackable / Empilable / Stapelbar / Apilable **1**



## 1111

- > Poltroncina girevole, telaio 5 razze in fusione alluminio, su ruote, seduta in polipropilene, regolabile in altezza.
- > Swivel armchair with 5-star die cast aluminium frame on castors, polypropylene shell, adjustable seat height.
- > Chaise pivotante avec accoudoirs, châssis 5 branches en fonte d'aluminium avec roulettes, coque en polypropylène, réglable en hauteur.
- > Drehbarer Armlehnstuhl mit 5-Sterne-Aluminiumgussrahmen und Rollen, Schale aus Polypropylen, Höhenverstellbar.
- > Sillón giratorio base 5 radios en aluminio con ruedas, carcasa en polipropileno, altura asiento regulable.

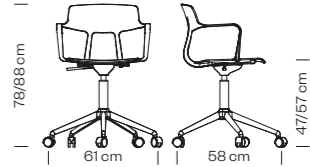

Peso / Weight / Poids / Gewicht / Peso **8,3 kg**

Imballo / Packaging / Emballage / Verpackung / Embalaje **0,50 m³**

Pezzi per scatola / Pieces for box / Pièces par carton / Stücke in einem Karton / Piezas por caja **1**

Impilabile / Stackable / Empilable / Stapelbar / Apilable **1**



# cuba

design  
**Marc Sadler**



archiproducts  
DESIGN AWARDS  
WINNER 2018











## 620

- > Sedia con telaio a 4 gambe in tubo acciaio. Seduta in polipropilene.
- > Chair with steel frame, 4 legs. Polypropylene shell.
- > Chaise avec châssis en acier 4 pieds et coque en polypropylène.
- > Stuhl mit 4-beinigem Stahlgestell. Sitzfläche aus Polypropylen.
- > Silla con estructura tubular 4 patas en acero, carcasa en polipropileno.



## 620N

- > Sedia con telaio a 4 gambe in tubo acciaio e seduta in polipropilene. Sedile imbottito rivestito in tessuto.
- > Chair with steel frame, 4 legs. Polypropylene shell. Upholstered seat.
- > Chaise avec châssis en acier 4 pieds et coque en polypropylène. Assise rembourrée.
- > Stuhl mit 4-beinigem Stahlgestell. Schale aus Polypropylen. Gepolsterte Sitzfläche.
- > Silla con estructura tubular 4 patas en acero y carcasa en polipropileno. Asiento tapizado.



## 621

- > Sedia con telaio a 4 gambe in tubo acciaio, con braccioli. Seduta in polipropilene.
- > Chair with armrests and steel frame, 4 legs. Polypropylene shell.
- > Chaise avec châssis en acier 4 pieds et accoudoirs. Coque en polypropylène.
- > Armlehnstuhl mit 4-beinigem Stahlgestell. Sitzfläche aus Polypropylen.
- > Silla con estructura tubular 4 patas en acero con brazos, carcasa en polipropileno.



## 621N

- > Sedia con telaio a 4 gambe in tubo acciaio, con braccioli. Seduta in polipropilene. Sedile imbottito rivestito in tessuto.
- > Chair with armrests and steel frame, 4 legs. Polypropylene shell. Upholstered seat.
- > Chaise avec châssis en acier 4 pieds et accoudoirs. Coque en polypropylène. Assise rembourrée.
- > Armlehnstuhl mit 4-beinigem Stahlgestell. Schale aus Polypropylen. Gepolsterte Sitzfläche.
- > Silla con estructura tubular 4 patas en acero con brazos, carcasa en polipropileno. Asiento tapizado.



## 622

- > Sedia con telaio a slitta in tondino acciaio. Seduta in polipropilene.
- > Chair with sled steel frame. Polypropylene shell.
- > Chaise avec châssis en fil d'acier pied luge. Coque en polypropylène.
- > Stuhl mit Kufengestell aus Stahlstangen. Sitzfläche aus Polypropylen.
- > Silla con estructura patin en acero, carcasa en polipropileno.

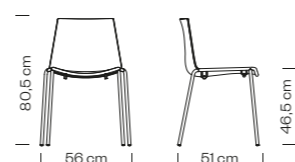

Peso / Weight / Poids / Gewicht / Peso **5,4 kg**

Imballo / Packaging / Emballage / Verpackung / Embalaje **0,39 m<sup>3</sup>**

Pezzi per scatola / Pieces per box / Pièces par carton / Stücke in einem Karton / Piezas por caja **4**

Impilabile / Stackable / Empilable / Stapelbar / Apilable **8**

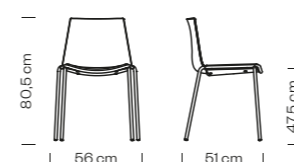

Peso / Weight / Poids / Gewicht / Peso **6,3 kg**

Imballo / Packaging / Emballage / Verpackung / Embalaje **0,39 m<sup>3</sup>**

Pezzi per scatola / Pieces per box / Pièces par carton / Stücke in einem Karton / Piezas por caja **4**

Impilabile / Stackable / Empilable / Stapelbar / Apilable **4**

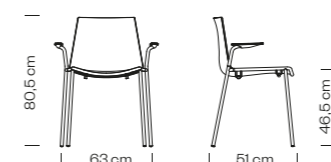

Peso / Weight / Poids / Gewicht / Peso **5,8 kg**

Imballo / Packaging / Emballage / Verpackung / Embalaje **0,47 m<sup>3</sup>**

Pezzi per scatola / Pieces per box / Pièces par carton / Stücke in einem Karton / Piezas por caja **4**

Impilabile / Stackable / Empilable / Stapelbar / Apilable **7**

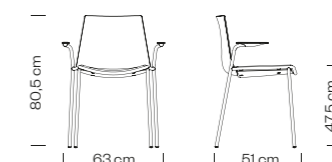

Peso / Weight / Poids / Gewicht / Peso **6,3 kg**

Imballo / Packaging / Emballage / Verpackung / Embalaje **0,47 m<sup>3</sup>**

Pezzi per scatola / Pieces per box / Pièces par carton / Stücke in einem Karton / Piezas por caja **4**

Impilabile / Stackable / Empilable / Stapelbar / Apilable **4**

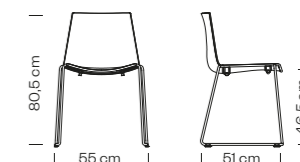

Peso / Weight / Poids / Gewicht / Peso **6,6 kg**

Imballo / Packaging / Emballage / Verpackung / Embalaje **0,39 m<sup>3</sup>**

Pezzi per scatola / Pieces per box / Pièces par carton / Stücke in einem Karton / Piezas por caja **4**

Impilabile / Stackable / Empilable / Stapelbar / Apilable **10**



## 622N

- > Sedia con telaio a slitta in tondino acciaio e seduta in polipropilene. Sedile imbottito rivestito in tessuto.
- > Chair with sled steel frame. Polypropylene shell. Upholstered seat.
- > Chaise avec châssis en fil d'acier pied luge. Coque en polypropylène. Assise rembourrée.
- > Stuhl mit Kufengestell aus Stahlstangen. Schale aus Polypropylen. Gepolsterte Sitzfläche.
- > Silla con estructura patin en acero, carcasa en polipropileno. Asiento tapizado.



## 623

- > Sgabello con telaio a 4 gambe in tubo acciaio. Seduta in polipropilene.
- > Barstool with steel frame, 4 legs. Polypropylene shell.
- > Tabouret avec chassis 4 pieds en acier. Coque en polypropylène.
- > Barhocker mit 4-beinigem Stahlgestell. Schale aus Polypropylen.
- > Taburete con estructura tubular 4 patas en acero, carcasa en polipropileno.



## 623B

- > Sgabello con telaio a 4 gambe in tubo acciaio. Seduta in polipropilene. Seduta: H 65 cm.
- > Barstool with steel frame, 4 legs. Polypropylene shell. Seat-height: H 65.
- > Tabouret avec chassis 4 pieds en acier. Coque en polypropylène. Hauteur assise: H 65 cm.
- > Barhocker mit 4-beinigem Stahlgestell. Schale aus Polypropylen. Sitzhöhe: H 65 cm.
- > Taburete con estructura tubular 4 patas en acero, carcasa en polipropileno. Altura asiento 65 cm.



## 1620

- > Sedia con telaio a 4 gambe in tubo acciaio. Seduta in polipropilene.
- > Chair with steel frame, 4 legs. Polypropylene shell.
- > Chaise avec châssis en acier 4 pieds et coque en polypropylène.
- > Stuhl mit 4-beinigem Stahlgestell. Sitzfläche aus Polypropylen.
- > Silla con estructura tubular 4 patas en acero, carcasa en polipropileno.



## 1623

- > Sgabello con telaio a 4 gambe in tubo acciaio. Seduta in polipropilene.
- > Barstool with steel frame, 4 legs. Polypropylene shell.
- > Tabouret avec chassis 4 pieds en acier. Coque en polypropylène.
- > Barhocker mit 4-beinigem Stahlgestell. Schale aus Polypropylen.
- > Taburete con estructura tubular 4 patas en acero, carcasa en polipropileno.



## 536

- > Carrello per 10 Cuba 620 / 10 Cuba 621 / 16 Cuba 622 / 10 Cuba 1620
- > Trolley for 10 Cuba 620 / 10 Cuba 621 / 16 Cuba 622 / 10 Cuba 1620
- > Chariot pour 10 Cuba 620 / 10 Cuba 621 / 16 Cuba 622 / 10 Cuba 1620
- > Transportwagen für 10 Cuba 620 / 10 Cuba 621 / 16 Cuba 622 / 10 Cuba 1620
- > Carrito por 10 Cuba 620 / 10 Cuba 621 / 16 Cuba 622 / 10 Cuba 1620

## AC

- > Finiture telaio (vedi p. 397)
- > Frame finishes (see p. 397)
- > Finitions piètement (voir p. 397)
- > Gestell Fertigungen (sehen S. 397)
- > Acabados estructura (ver p. 397)

## TE

- > Finiture seduta (vedi p. 375)
- > Seat finishes (see p. 375)
- > Finitions de l'assise (voir p. 375)
- > Sitzfertigungen (sehen S. 375)
- > Acabados asiento (ver p. 375)

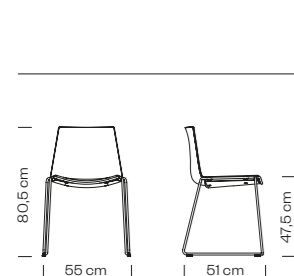

Peso / Weight / Poids / Gewicht / Peso **7,5 kg**

Imballo / Packaging / Emballage / Verpackung / Embalaje **0,39 m³**

Pezzi per scatola / Pieces per box / Pièces par carton / Stücke in einem Karton / Piezas por caja **4**

Impilabile / Stackable / Empilable / Stapelbar / Apilable **4**

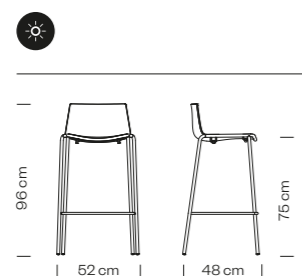

Peso / Weight / Poids / Gewicht / Peso **6,3 kg**

Imballo / Packaging / Emballage / Verpackung / Embalaje **0,36 m³**

Pezzi per scatola / Pieces per box / Pièces par carton / Stücke in einem Karton / Piezas por caja **4**

Impilabile / Stackable / Empilable / Stapelbar / Apilable **8**

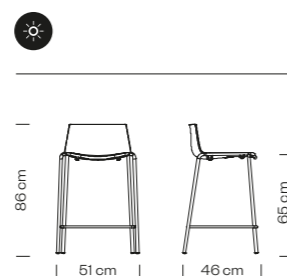

Peso / Weight / Poids / Gewicht / Peso **6 kg**

Imballo / Packaging / Emballage / Verpackung / Embalaje **0,36 m³**

Pezzi per scatola / Pieces per box / Pièces par carton / Stücke in einem Karton / Piezas por caja **4**

Impilabile / Stackable / Empilable / Stapelbar / Apilable **8**

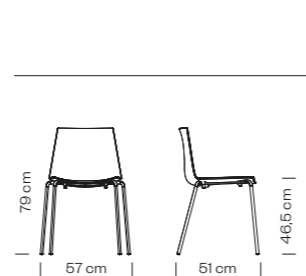

Peso / Weight / Poids / Gewicht / Peso **5 kg**

Imballo / Packaging / Emballage / Verpackung / Embalaje **0,36 m³**

Pezzi per scatola / Pieces per box / Pièces par carton / Stücke in einem Karton / Piezas por caja **4**

Impilabile / Stackable / Empilable / Stapelbar / Apilable **8**

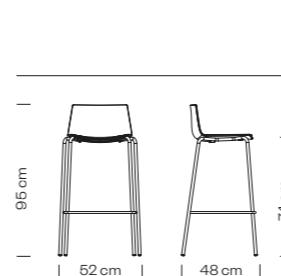

Peso / Weight / Poids / Gewicht / Peso **6 kg**

Imballo / Packaging / Emballage / Verpackung / Embalaje **0,36 m³**

Pezzi per scatola / Pieces per box / Pièces par carton / Stücke in einem Karton / Piezas por caja **4**

Impilabile / Stackable / Empilable / Stapelbar / Apilable **4**



### Accessori / Accessories / Accessoires / Zubehoer / Accesorios

- > Pedana in lamiera per impilabilità sedie 620/621/1620: impilabilità fino a 10 pz.
- > Metal plate support for 620/621/1620: Stacks 10 pcs.
- > Support fixe pour chaise 620/621/1620: permet d'empiler jusqu'à 10 pieces.
- > Sockel aus Blech zum Stapeln von Stühlen 620/621/1620: Stapeln bis zu 10 Stück.
- > Plataforma de chapa para apilamiento sillas 620/621/1620: apilables hasta 10 piezas.



### Accessori / Accessories / Accessoires / Zubehoer / Accesorios

- > Sistema di aggancio 622 / 622N: Kit composto da 4 agganci (2 maschi e 2 femmine).
- > Linking device 622 / 622N: Kit composed by 4 pcs (2 male and 2 female).
- > Système d'accrochage 622 / 622N: kit composé par 4 pièces (2 mâles et 2 femelles).
- > Kupplungssystem 622 / 622N: Set bestehend aus 4 Haken (2 männlicher und 2 weiblicher Haken).
- > Sistema de enganche 622 / 622N: Kit compuesto por 4 enganches (2 machos y 2 hembras).

## PP

- > Finiture seduta
- > Seat finishes
- > Finitions de l'assise
- > Sitzfertigungen
- > Acabados asiento





# main



design  
**Lorenzo Damiani**



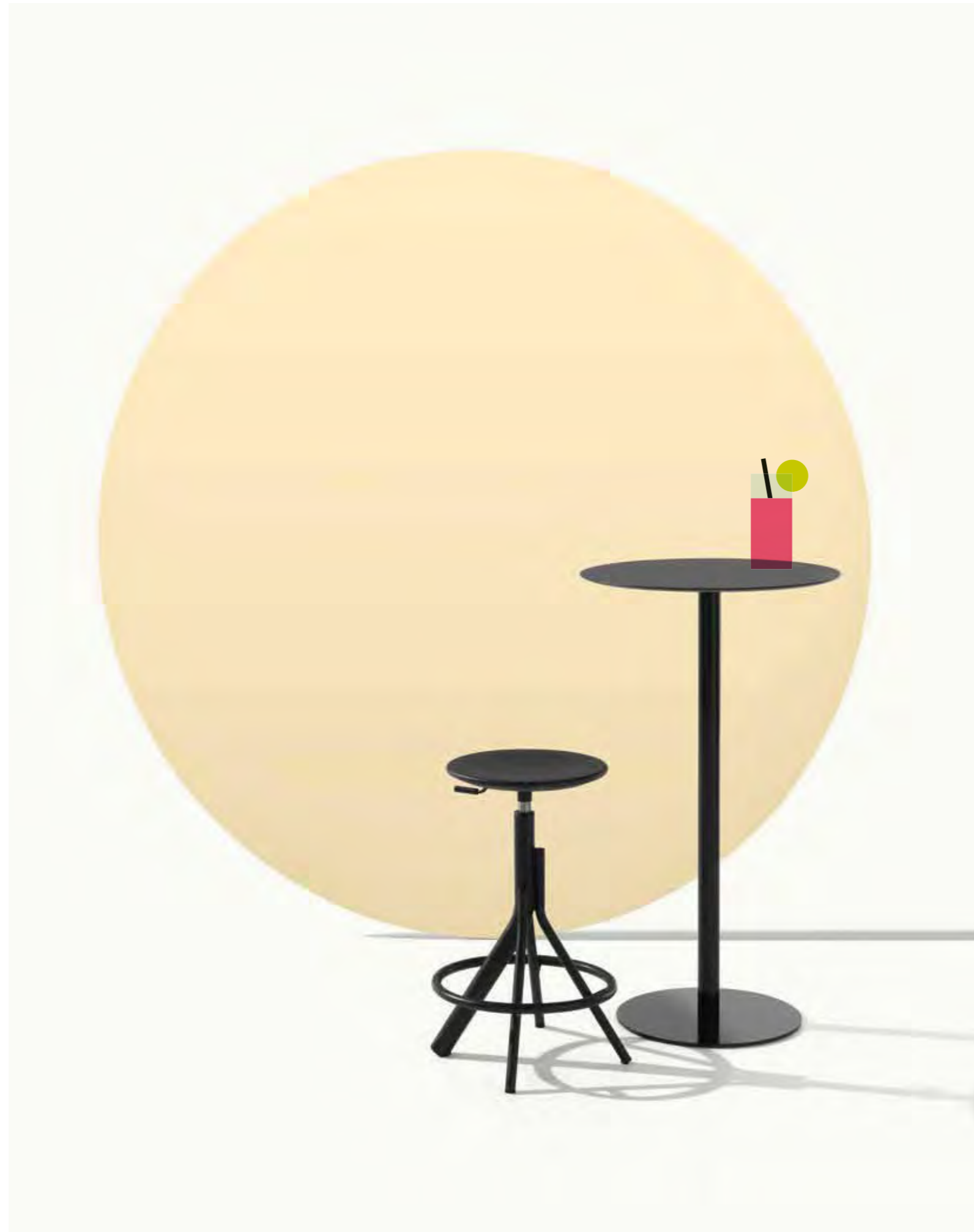

## 1120

- > Sgabello con telaio 4 gambe in tubo acciaio. Seduta in legno di frassino, girevole e regolabile in altezza.
- > Barstool with steel frame, 4 legs. Ash wood swivel seat with gas lift device.
- > Tabouret avec châssis en acier 4 pieds. Assise en bois de frêne, pivotante et réglable en hauteur.
- > Barhocker mit 4-beinigem Stahlgestell. Sitz aus Eschenholz, drehbar und höhenverstellbar.
- > Taburete 4 patas en tubular de acero. Asiento en fresno, giratorio y regulable en altura.

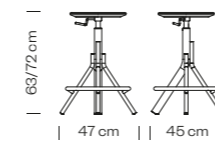

Peso / Weight / Poids / Gewicht / Peso **7,2 Kg**

Imballo / Packaging / Emballage / Verpackung / Embalaje **0,14 m³**

Pezzi per scatola / Pieces for box / Pièces par carton / Stücke in einem Karton / Piezas por caja **1**



## 1121

- > Sgabello con telaio 3 gambe in tubo acciaio. Seduta girevole in legno di frassino.
- > Barstool with steel frame, 3 legs. Ash wood swivel seat.
- > Tabouret avec châssis en acier 3 pieds. Assise en bois de frêne, pivotante.
- > Barhocker mit 3-beinigem Stahlgestell. Sitz aus Eschenholz, drehbar.
- > Taburete 3 patas en tubular de acero. Asiento giratorio en fresno.

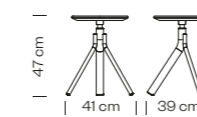

Peso / Weight / Poids / Gewicht / Peso **4,7 Kg**

Imballo / Packaging / Emballage / Verpackung / Embalaje **0,12 m³**

Pezzi per scatola / Pieces for box / Pièces par carton / Stücke in einem Karton / Piezas por caja **1**

## AC

- > Finiture telaio (vedi p. 397)
- > Frame finishes (see p. 397)
- > Finitions piètement (voir p. 397)
- > Gestell Fertigungen (sehen S. 397)
- > Acabados estructura (ver p. 397)

## LE

- > Finiture seduta
- > Seat finishes
- > Finitions de l'assise
- > Sitzfertigungen
- > Acabados asiento





# ambit

design  
Giovanni Levanti

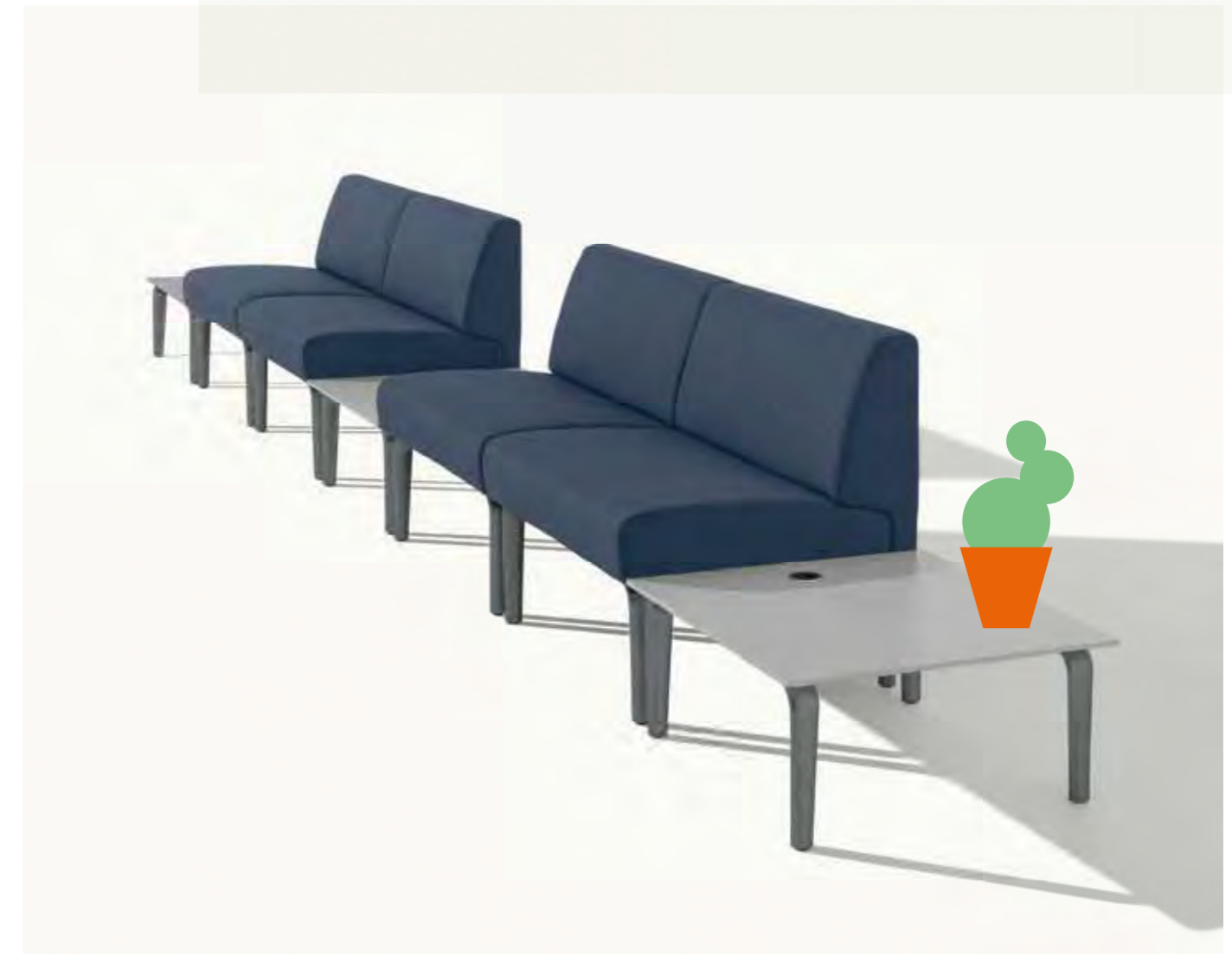
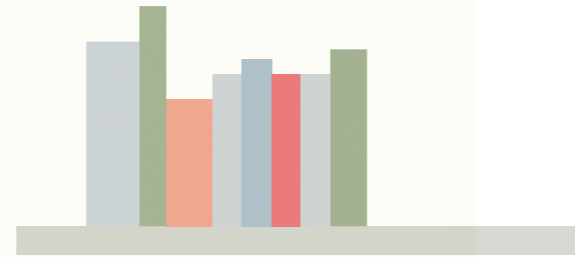

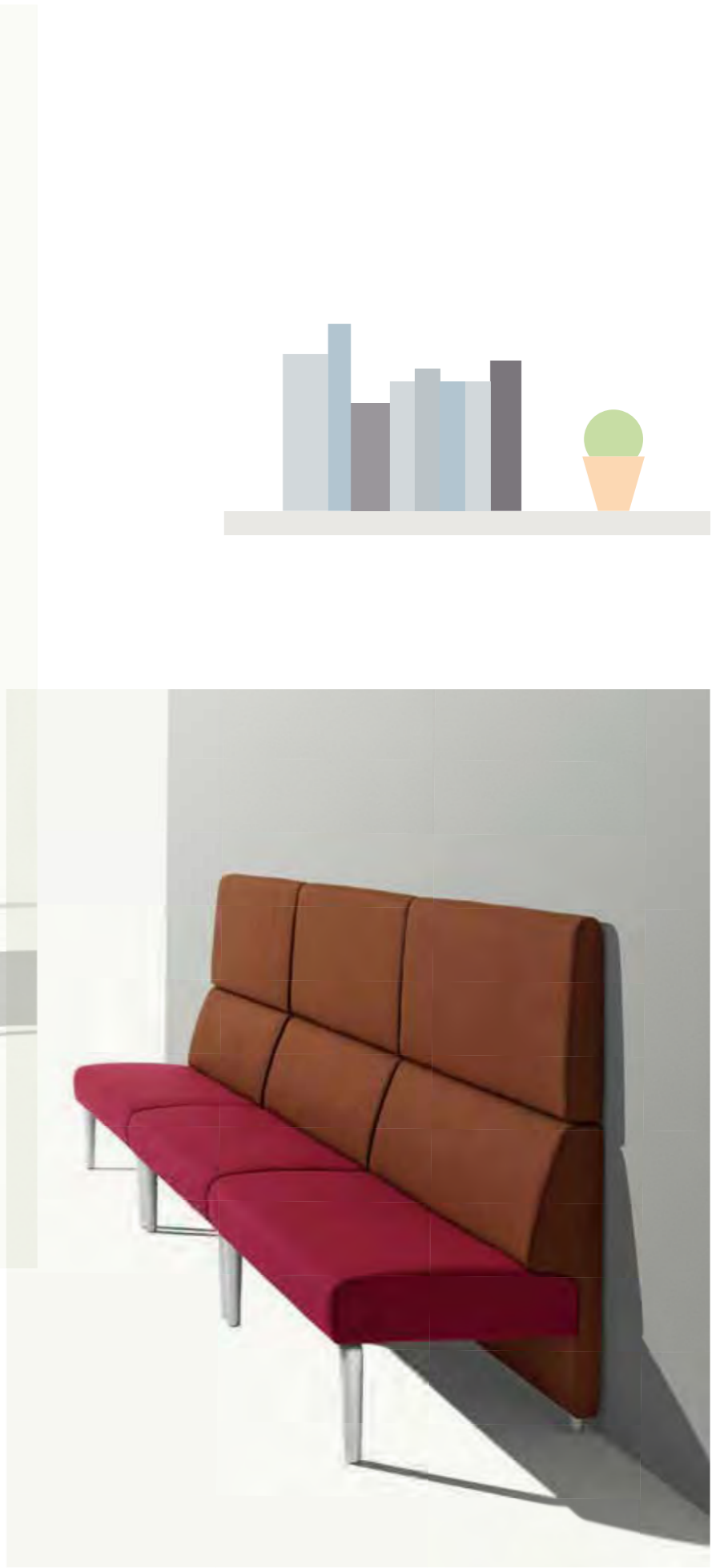
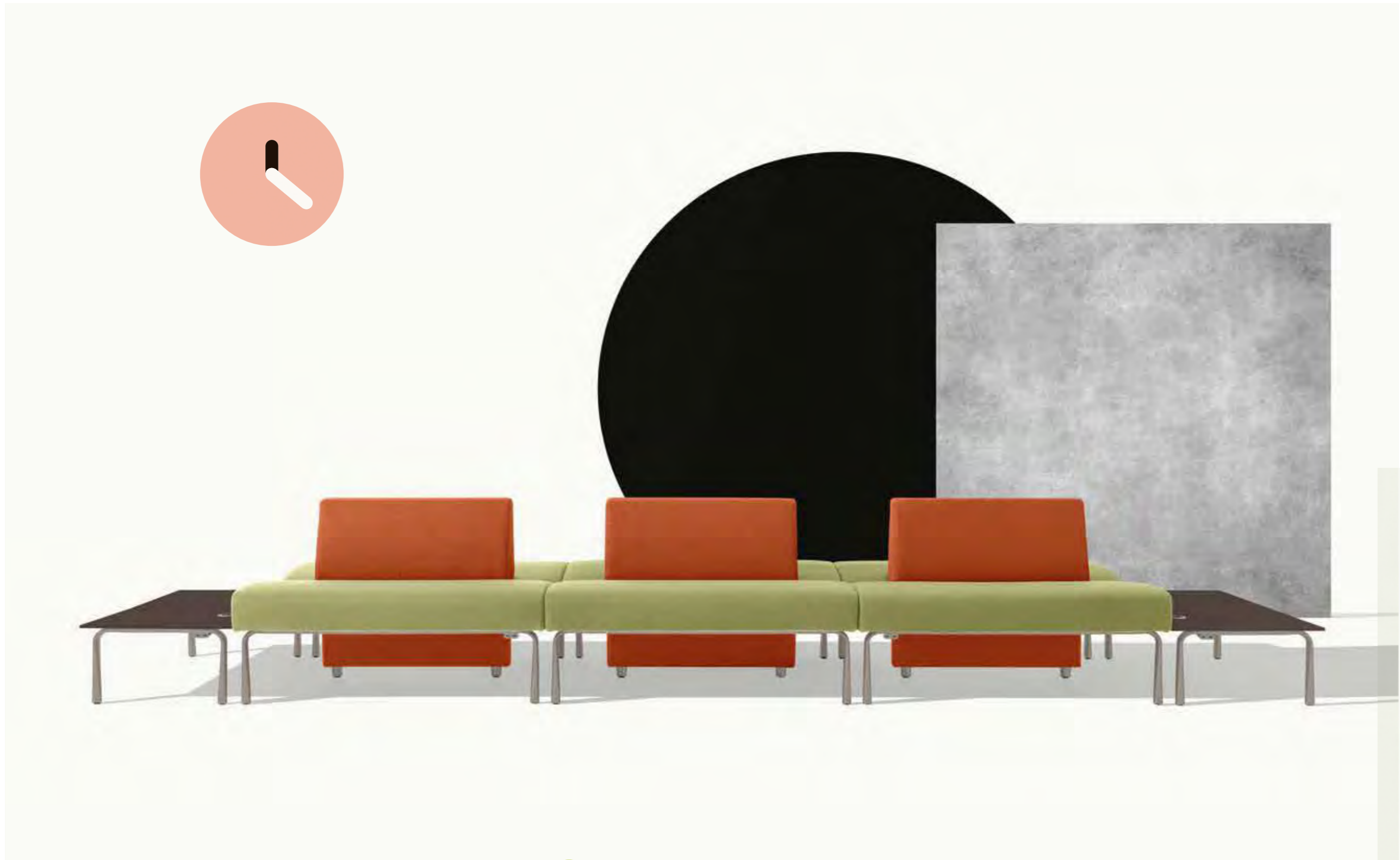

accessori / accessories



- > Presa di corrente sul piano del tavolino.
- > Power socket on the table top.
- > Prise électrique sur le plateau de table.
- > Steckdose auf der Tischplatte.
- > Enchufe tipo Schuko sobre el tope de mesa.



- > Presa usb per sedute imbottite e tavolini.
- > USB socket for upholstered seats and tables.
- > Prise électrique sur le plateau de table.
- > Steckdose auf der Tischplatte.
- > Cargador USB para asientos y poufs tapizados.





## TE

- > Finiture seduta (vedi p. 375)
- > Seat finishes (see p. 375)
- > Finitions de l'assise (voir p. 375)
- > Sitzfertigungen (sehen S. 375)
- > Acabados asiento (ver p. 375)

## AL VR

- > Finiture telaio (vedi p. 400)
- > Frame finishes (see p. 400)
- > Finitions piètement (voir p. 400)
- > Gestell Fertigungen (sehen S. 400)
- > Acabados estructura (ver p. 400)

## STR

- > Finiture piani tavoli
- > Table tops finishes
- > Finitions plateaux de table
- > Tischplattenfertigungen
- > Acabados por sobrees de mesas



### 1040

- > Sistema sedute multiple. Sedile e schienale imbottiti. Piedi in fusione alluminio. Modulo lineare L 80 cm, schienale H 77 cm.
- > Modular seating system. Upholstered seat and back. Feet in cast aluminium. Linear module L 80 cm, backrest H 77 cm.
- > Système d'assise modulaire. Assise et dossier rembourrés. Pieds en fonte d'aluminium. Module linéaire L 80 cm, dossier H 77 cm.
- > Modulares Sitzsystem. Sitz und Rücken gepolstert. Füße aus Aluminiumguss. Linear modul L 80 cm, Rückenlehne H 77 cm.
- > Sistema de bancos modular. Asiento y respaldo tapizado. Patas en fundición de aluminio. Módulo lineal L 80 cm, respaldo H 77 cm

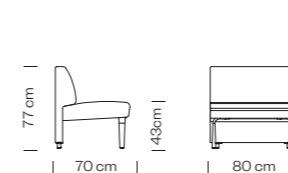

Peso / Weight / Poids / Gewicht / Peso **25,7 Kg**

Imballo / Packaging / Emballage / Verpackung / Embalaje **0,45 m³**

Pezzi per scatola / Pieces for box / Pièces par carton / Stücke in einem Karton / Piezas por caja **1**



### 1041

- > Sistema sedute multiple. Sedile e schienale imbottiti. Piedi in fusione alluminio. Modulo lineare L 80 cm, schienale H 127 cm.
- > Modular seating system. Upholstered seat and back. Feet in cast aluminium. Linear module L 80 cm, backrest H 127 cm.
- > Sistema sedute multiple. Sedile e schienale imbottiti. Piedi in fusione alluminio. Modulo lineare L 80 cm, schienale H 127 cm.
- > Modulares Sitzsystem. Sitz und Rücken gepolstert. Füße aus Aluminiumguss. Linear modul L 80 cm, Rückenlehne H 127 cm.
- > Sistema de bancos modular. Asiento y respaldo tapizado. Patas en fundición de aluminio. Módulo lineal L 80 cm, respaldo H 127 cm.

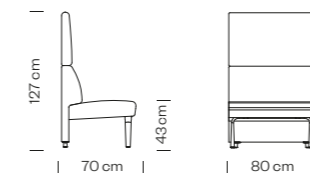

Peso / Weight / Poids / Gewicht / Peso **30,7 Kg**

Imballo / Packaging / Emballage / Verpackung / Embalaje **0,45 m³**

Pezzi per scatola / Pieces for box / Pièces par carton / Stücke in einem Karton / Piezas por caja **1**



### 1045

- > Sistema sedute multiple. Sedile e schienale imbottiti. Piedi in fusione alluminio. Modulo lineare L 80 cm, schienale H 77 cm. Versione bifacciale.
- > Modular seating system. Upholstered seat and back. Feet in cast aluminium. Linear module L 80 cm, backrest H 77 cm. Double-sided version.
- > Système d'assise modulaire. Assise et dossier rembourrés. Pieds en fonte d'aluminium. Module linéaire L 80 cm, dossier H 77 cm. Version double face.
- > Modulares Sitzsystem. Sitz und Rücken gepolstert. Füße aus Aluminiumguss. Linear modul L 80 cm, Rückenlehne H 77 cm. Doppelseitige Version.
- > Sistema de bancos modular. Asiento y respaldo tapizado. Patas en fundición de aluminio. Módulo lineal L 80 cm, respaldo H 77 cm. Versión bifacial.

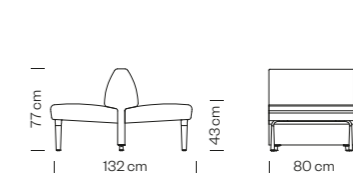

Peso / Weight / Poids / Gewicht / Peso **37,6 Kg**

Imballo / Packaging / Emballage / Verpackung / Embalaje **0,95 m³**

Pezzi per scatola / Pieces for box / Pièces par carton / Stücke in einem Karton / Piezas por caja **1**



### 1046

- > Sistema sedute multiple. Sedile e schienale imbottiti. Piedi in fusione alluminio. Modulo lineare L 80 cm, schienale H 127 cm. Versione bifacciale.
- > Modular seating system. Upholstered seat and back. Feet in cast aluminium. Linear module L 80 cm, backrest H 127 cm. Double-sided version.
- > Système d'assise modulaire. Assise et dossier rembourrés. Pieds en fonte d'aluminium. Module linéaire L 80 cm, dossier H 127 cm. Version double face.
- > Modulares Sitzsystem. Sitz und Rücken gepolstert. Füße aus Aluminiumguss. Linear modul L 80 cm, Rückenlehne H 127 cm. Doppelseitige Version.
- > Sistema de bancos modular. Asiento y respaldo tapizado. Patas en fundición de aluminio. Módulo lineal L 80 cm, respaldo H 127 cm. Versión bifacial.

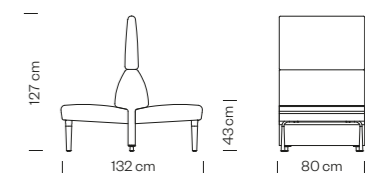

Peso / Weight / Poids / Gewicht / Peso **43,3 Kg**

Imballo / Packaging / Emballage / Verpackung / Embalaje **0,95 m³**

Pezzi per scatola / Pieces for box / Pièces par carton / Stücke in einem Karton / Piezas por caja **1**



## 1047

- > Sistema sedute multiple. Sedile e schienale imbottiti. Piedi in fusione alluminio. Modulo lineare L 80 cm, schienale H 99 cm. Versione bifacciale.
- > Modular seating system. Upholstered seat and back. Feet in cast aluminium. Linear module L 80 cm, backrest H 99 cm. Double-sided version.
- > Système d'assise modulaire. Assise et dossier rembourrés. Pieds en fonte d'aluminium. Module linéaire L 80 cm, dossier H 99 cm. Version double face.
- > Modulares Sitzsystem. Sitz und Rücken gepolstert. Füße aus Aluminiumguss. Linearmodul L 80 cm, Rückenlehne H 99 cm. Doppelseitige Version.
- > Sistema de bancos modular. Asiento y respaldo tapizado. Patas en fundición de aluminio. Módulo lineal L 80 cm, respaldo H 99 cm. Versión bifacial.



## 1050

- > Sistema sedute multiple. Sedile e schienale imbottiti. Piedi in fusione alluminio. Modulo lineare seduta L 120 cm e schienale L 80 cm, schienale H 77 cm.
- > Modular seating system. Upholstered seat and back. Feet in cast aluminium. Linear module seat L 120 cm and backrest L 80 cm, backrest H 77 cm.
- > Système d'assise modulaire. Assise et dossier rembourrés. Pieds en fonte d'aluminium. Siège module linéaire L 120 cm et dossier L 80 cm, dossier H 77 cm.
- > Modulares Sitzsystem. Sitz und Rücken gepolstert. Füße aus Aluminiumguss. Linearmodulsitz L 120 cm und Rückenlehne L 80 cm, Rückenlehne H 77 cm.
- > Sistema de bancos modular. Asiento y respaldo tapizado. Patas en fundición de aluminio. Módulo lineal asiento L 120 cm y respaldo L 80 cm, respaldo H 77 cm.



## 1051

- > Sistema sedute multiple. Sedile e schienale imbottiti. Piedi in fusione alluminio. Modulo lineare seduta L 120 cm e schienale L 80 cm, schienale H 127 cm.
- > Modular seating system. Upholstered seat and back. Feet in cast aluminium. Linear module seat L 120 cm and backrest L 80 cm, backrest H 127 cm.
- > Système d'assise modulaire. Assise et dossier rembourrés. Pieds en fonte d'aluminium. Siège module linéaire L 120 cm et dossier L 80 cm, dossier H 127 cm.
- > Modulares Sitzsystem. Sitz und Rücken gepolstert. Füße aus Aluminiumguss. Linearmodulsitz L 120 cm und Rückenlehne L 80 cm, Rückenlehne H 127 cm.
- > Sistema de bancos modular. Asiento y respaldo tapizado. Patas en fundición de aluminio. Módulo lineal asiento L 120 cm y respaldo L 80 cm, respaldo H 127 cm.



## 1055

- > Sistema sedute multiple. Sedile e schienale imbottiti. Piedi in fusione alluminio. Modulo lineare seduta L 120 cm e schienale L 80 cm, schienale H 77 cm. Versione bifacciale.
- > Modular seating system. Upholstered seat and back. Feet in cast aluminium. Linear module seat L 120 cm and backrest L 80 cm, backrest H 77 cm. Double-sided version.
- > Système d'assise modulaire. Assise et dossier rembourrés. Pieds en fonte d'aluminium. Siège module linéaire L 120 cm et dossier L 80 cm, dossier H 77 cm. Version double face.
- > Modulares Sitzsystem. Sitz und Rücken gepolstert. Füße aus Aluminiumguss. Linearmodulsitz L 120 cm und Rückenlehne L 80 cm, Rückenlehne H 77 cm. Doppelseitige Version.
- > Sistema de bancos modular. Asiento y respaldo tapizado. Patas en fundición de aluminio. Módulo lineal asiento L 120 cm y respaldo L 80 cm, respaldo H 77 cm. Versión bifacial.



## 1056

- > Sistema sedute multiple. Sedile e schienale imbottiti. Piedi in fusione alluminio. Modulo lineare seduta L 120 cm e schienale L 80 cm, schienale H 127 cm. Versione bifacciale.
- > Modular seating system. Upholstered seat and back. Feet in cast aluminium. Linear module seat L 120 cm and backrest L 80 cm, backrest H 127 cm. Double-sided version.
- > Système d'assise modulaire. Assise et dossier rembourrés. Pieds en fonte d'aluminium. Siège module linéaire L 120 cm et dossier L 80 cm, dossier H 127 cm. Version double face.
- > Modulares Sitzsystem. Sitz und Rücken gepolstert. Füße aus Aluminiumguss. Linearmodulsitz L 120 cm und Rückenlehne L 80 cm, Rückenlehne H 127 cm. Doppelseitige Version.
- > Sistema de bancos modular. Asiento y respaldo tapizado. Patas en fundición de aluminio. Módulo lineal asiento L 120 cm y respaldo L 80 cm, respaldo H 127 cm. Versión bifacial.



## 1057

- > Sistema sedute multiple. Sedile e schienale imbottiti. Piedi in fusione alluminio. Modulo lineare seduta L 120 cm e schienale L 80 cm, schienale H 99 cm. Versione bifacciale.
- > Modular seating system. Upholstered seat and back. Feet in cast aluminium. Linear module seat L 120 cm and backrest L 80 cm, backrest H 99 cm. Double-sided version.
- > Système d'assise modulaire. Assise et dossier rembourrés. Pieds en fonte d'aluminium. Siège module linéaire L 120 cm et dossier L 80 cm, dossier H 99 cm. Version double face.
- > Modulares Sitzsystem. Sitz und Rücken gepolstert. Füße aus Aluminiumguss. Linearmodul L 120 cm, Rückenlehne H 99 cm. Doppelseitige Version.
- > Sistema de bancos modular. Asiento y respaldo tapizado. Patas en fundición de aluminio. Módulo lineal asiento L 120 cm y respaldo L 80 cm, respaldo H 99 cm. Versión bifacial.



## 1060

- > Sistema sedute multiple. Sedile e schienale imbottiti. Piedi in fusione alluminio. Modulo lineare L 120 cm, schienale H 77 cm.
- > Modular seating system. Upholstered seat and back. Feet in cast aluminium. Linear module L 120 cm, backrest H 77 cm.
- > Système d'assise modulaire. Assise et dossier rembourrés. Pieds en fonte d'aluminium. Module linéaire L 120 cm, dossier H 77 cm.
- > Modulares Sitzsystem. Sitz und Rücken gepolstert. Füße aus Aluminiumguss. Linearmodul L 120 cm, Rückenlehne H 77 cm.
- > Sistema de bancos modular. Asiento y respaldo tapizado. Patas en fundición de aluminio. Módulo lineal L 120 cm, respaldo H 77 cm.



## 1061

- > Sistema sedute multiple. Sedile e schienale imbottiti. Piedi in fusione alluminio. Modulo lineare L 120 cm, schienale H 127 cm.
- > Modular seating system. Upholstered seat and back. Feet in cast aluminium. Linear module L 120 cm, backrest H 127 cm.
- > Système d'assise modulaire. Assise et dossier rembourrés. Pieds en fonte d'aluminium. Module linéaire L 120 cm, dossier H 127 cm.
- > Modulares Sitzsystem. Sitz und Rücken gepolstert. Füße aus Aluminiumguss. Linearmodul L 120 cm, Rückenlehne H 127 cm.
- > Sistema de bancos modular. Asiento y respaldo tapizado. Patas en fundición de aluminio. Módulo lineal L 120 cm, respaldo H 127 cm.

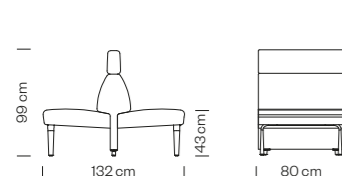

Peso / Weight / Poids / Gewicht / Peso **41,2 Kg**

Imballo / Packaging / Emballage / Verpackung / Embalaje **0,95 m<sup>3</sup>**

Pezzi per scatola / Pieces for box / Pièces par carton / Stücke in einem Karton / Piezas por caja **1**

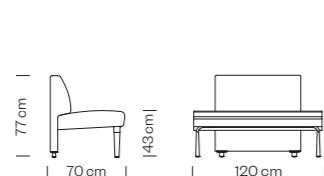

Peso / Weight / Poids / Gewicht / Peso **28,7 Kg**

Imballo / Packaging / Emballage / Verpackung / Embalaje **0,79 m<sup>3</sup>**

Pezzi per scatola / Pieces for box / Pièces par carton / Stücke in einem Karton / Piezas por caja **1**

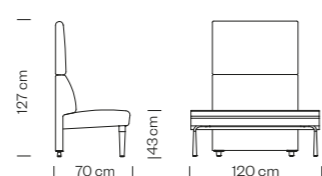

Peso / Weight / Poids / Gewicht / Peso **34,7 Kg**

Imballo / Packaging / Emballage / Verpackung / Embalaje **0,79 m<sup>3</sup>**

Pezzi per scatola / Pieces for box / Pièces par carton / Stücke in einem Karton / Piezas por caja **1**

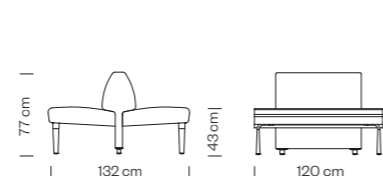

Peso / Weight / Poids / Gewicht / Peso **45 Kg**

Imballo / Packaging / Emballage / Verpackung / Embalaje **1,40 m<sup>3</sup>**

Pezzi per scatola / Pieces for box / Pièces par carton / Stücke in einem Karton / Piezas por caja **1**

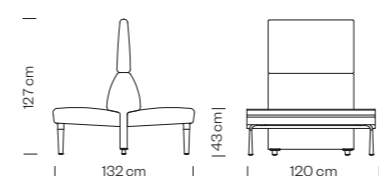

Peso / Weight / Poids / Gewicht / Peso **50,5 Kg**

Imballo / Packaging / Emballage / Verpackung / Embalaje **1,40 m<sup>3</sup>**

Pezzi per scatola / Pieces for box / Pièces par carton / Stücke in einem Karton / Piezas por caja **1**

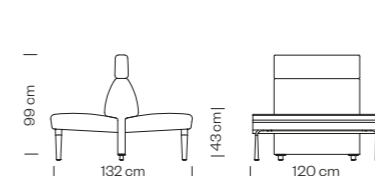

Peso / Weight / Poids / Gewicht / Peso **48,6 Kg**

Imballo / Packaging / Emballage / Verpackung / Embalaje **1,40 m<sup>3</sup>**

Pezzi per scatola / Pieces for box / Pièces par carton / Stücke in einem Karton / Piezas por caja **1**

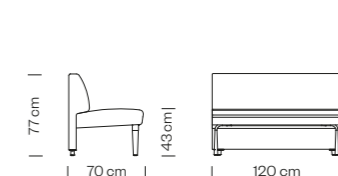

Peso / Weight / Poids / Gewicht / Peso **32 Kg**

Imballo / Packaging / Emballage / Verpackung / Embalaje **0,79 m<sup>3</sup>**

Pezzi per scatola / Pieces for box / Pièces par carton / Stücke in einem Karton / Piezas por caja **1**

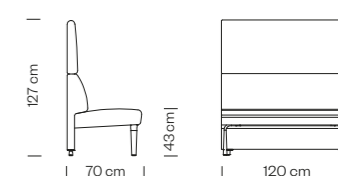

Peso / Weight / Poids / Gewicht / Peso **38 Kg**

Imballo / Packaging / Emballage / Verpackung / Embalaje **0,79 m<sup>3</sup>**

Pezzi per scatola / Pieces for box / Pièces par carton / Stücke in einem Karton / Piezas por caja **1**



# 1065

- > Sistema sedute multiple. Sedile e schienale imbottiti. Piedi in fusione alluminio. Modulo lineare L 120 cm, schienale H 77 cm. Versione bifacciale.
- > Modular seating system. Upholstered seat and back. Feet in cast aluminium. Linear module L 120 cm, backrest H 77 cm. Double-sided version.
- > Système d'assise modulaire. Assise et dossier rembourrés. Pieds en fonte d'aluminium. Module linéaire L 120 cm, dossier H 77 cm. Version double face.
- > Modulares Sitzsystem. Sitz und Rücken gepolstert. Füße aus Aluminiumguss. Linearmodul L 120 cm, Rückenlehne H 77 cm. Doppelseitige Version.
- > Sistema de bancos modular. Asiento y respaldo tapizado. Patas en fundición de aluminio. Módulo lineal L 120 cm, respaldo H 77 cm. Versión bifacial.



# 1066

- > Sistema sedute multiple. Sedile e schienale imbottiti. Piedi in fusione alluminio. Modulo lineare L 120 cm, schienale H 127 cm. Versione bifacciale.
- > Modular seating system. Upholstered seat and back. Feet in cast aluminium. Linear module L 120 cm, backrest H 127 cm. Double-sided version.
- > Système d'assise modulaire. Assise et dossier rembourrés. Pieds en fonte d'aluminium. Module linéaire L 120 cm, dossier H 127 cm. Version double face.
- > Modulares Sitzsystem. Sitz und Rücken gepolstert. Füße aus Aluminiumguss. Linearmodul L 120 cm, Rückenlehne H 127 cm. Doppelseitige Version.
- > Sistema de bancos modular. Asiento y respaldo tapizado. Patas en fundición de aluminio. Módulo lineal L 120 cm, respaldo H 127 cm. Versión bifacial.



# 1067

- > Sistema sedute multiple. Sedile e schienale imbottiti. Piedi in fusione alluminio. Modulo lineare L 120 cm, schienale H 99 cm. Versione bifacciale.
- > Modular seating system. Upholstered seat and back. Feet in cast aluminium. Linear module L 120 cm, backrest H 99 cm. Double-sided version.
- > Système d'assise modulaire. Assise et dossier rembourrés. Pieds en fonte d'aluminium. Module linéaire L 120 cm, dossier H 99 cm. Version double face.
- > Modulares Sitzsystem. Sitz und Rücken gepolstert. Füße aus Aluminiumguss. Linearmodul L 120 cm, Rückenlehne H 99 cm. Doppelseitige Version.
- > Sistema de bancos modular. Asiento y respaldo tapizado. Patas en fundición de aluminio. Módulo lineal L 120 cm, respaldo H 99 cm. Versión bifacial.



# 1070

- > Sistema sedute multiple. Sedile imbottito. Piedi in fusione alluminio. Modulo lineare L 120 cm.
- > Modular seating system. Upholstered seat. Feet in cast aluminium. Linear module L 120 cm.
- > Système d'assise modulaire. Siège rembourré. Pieds en fonte aluminium. Module linéaire L 120 cm.
- > Modulares Sitzsystem. Gepolsterter Sitz. Füße aus Aluminiumguss. Linearmodul L 120 cm.
- > Sistema de bancos modular. Asiento tapizado. Patas en fundición de aluminio. Módulo lineal L 120 cm.



# 1071

- > Sistema sedute multiple. Sedile imbottito. Piedi in fusione alluminio. Modulo lineare L 120 cm. Versione bifacciale.
- > Modular seating system. Upholstered seat. Feet in cast aluminium. Linear module L 120 cm. Double-sided version.
- > Système d'assise modulaire. Siège rembourré. Pieds en fonte aluminium. Module linéaire L 120 cm.
- > Modulares Sitzsystem. Gepolsterter Sitz. Füße aus Aluminiumguss. Linearmodul L 120 cm.
- > Sistema de bancos modular. Asiento tapizado. Patas en fundición de aluminio. Módulo lineal L 120 cm. Versión bifacial.



# 1075

- > Sistema sedute multiple. Tavolino per composizione lineare. Piedi in fusione alluminio.
- > Modular seating system. Coffee table for linear composition. Feet in cast aluminium.
- > Système d'assise modulaire. Table basse pour composition linéaire. Pieds en fonte d'aluminium.
- > Modulares Sitzsystem. Couchtisch für lineare Komposition. Füße aus Aluminiumguss.
- > Sistema de bancos modular. Mesita para composiciones lineal. Patas en fundición de aluminio.



# 1076

- > Sistema sedute multiple. Tavolino per composizione angolare. Piedi in fusione alluminio.
- > Modular seating system. Coffee table for corner composition. Feet in cast aluminium.
- > Système d'assise modulaire. Table basse pour composition d'angle. Pieds en fonte d'aluminium.
- > Modulares Sitzsystem. Couchtisch für Eckaufbau. Füße aus Aluminiumguss.
- > Sistema de bancos modular. Mesita para composiciones de esquinas. Patas en fundición de aluminio.



# 1077

- > Sistema sedute multiple. Tavolino per composizione lineare. Piedi in fusione alluminio. Versione bifacciale.
- > Modular seating system. Coffee table for linear composition. Feet in cast aluminium. Double-sided version.
- > Système d'assise modulaire. Table basse pour composition linéaire. Pieds en fonte d'aluminium. Version double face.
- > Modulares Sitzsystem. Couchtisch für lineare Komposition. Füße aus Aluminiumguss. Doppelseitige Version.
- > Sistema de bancos modular. Mesita para composiciones lineal. Patas en fundición de aluminio. Versión bifacial.

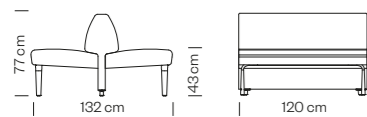

Peso / Weight / Poids / Gewicht / Peso **48 Kg**

Imballo / Packaging / Emballage / Verpackung / Embalaje **1,40 m³**

Pezzi per scatola / Pieces for box / Pièces par carton / Stücke in einem Karton / Piezas por caja **1**

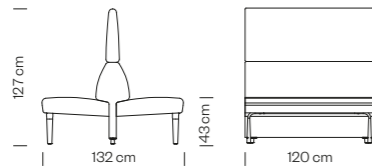

Peso / Weight / Poids / Gewicht / Peso **54 Kg**

Imballo / Packaging / Emballage / Verpackung / Embalaje **1,40 m³**

Pezzi per scatola / Pieces for box / Pièces par carton / Stücke in einem Karton / Piezas por caja **1**

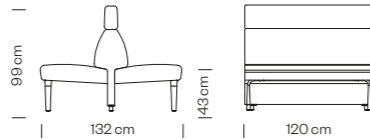

Peso / Weight / Poids / Gewicht / Peso **53 Kg**

Imballo / Packaging / Emballage / Verpackung / Embalaje **1,40 m³**

Pezzi per scatola / Pieces for box / Pièces par carton / Stücke in einem Karton / Piezas por caja **1**



Peso / Weight / Poids / Gewicht / Peso **18,6 Kg**

Imballo / Packaging / Emballage / Verpackung / Embalaje **0,50 m³**

Pezzi per scatola / Pieces for box / Pièces par carton / Stücke in einem Karton / Piezas por caja **1**

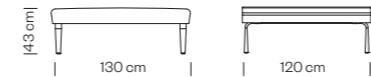

Peso / Weight / Poids / Gewicht / Peso **30 Kg**

Imballo / Packaging / Emballage / Verpackung / Embalaje **0,50 m³**

Pezzi per scatola / Pieces for box / Pièces par carton / Stücke in einem Karton / Piezas por caja **1**



Peso / Weight / Poids / Gewicht / Peso **13,8 Kg**

Imballo / Packaging / Emballage / Verpackung / Embalaje **0,50 m³**

Pezzi per scatola / Pieces for box / Pièces par carton / Stücke in einem Karton / Piezas por caja **2**

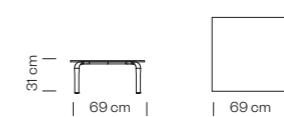

Peso / Weight / Poids / Gewicht / Peso **14,2 Kg**

Imballo / Packaging / Emballage / Verpackung / Embalaje **0,50 m³**

Pezzi per scatola / Pieces for box / Pièces par carton / Stücke in einem Karton / Piezas por caja **2**

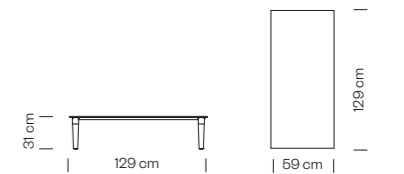

Peso / Weight / Poids / Gewicht / Peso **20 Kg**

Imballo / Packaging / Emballage / Verpackung / Embalaje **0,60 m³**

Pezzi per scatola / Pieces for box / Pièces par carton / Stücke in einem Karton / Piezas por caja **1**



# pillow

design  
**Andrea Anastasio**







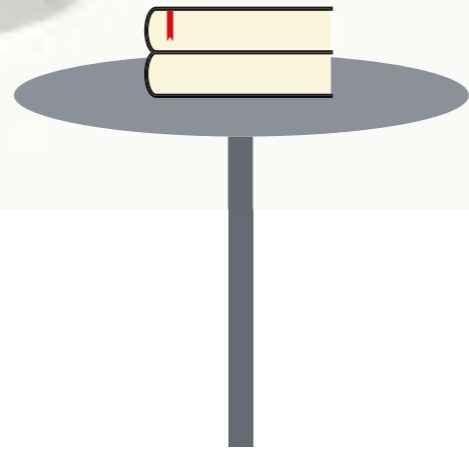

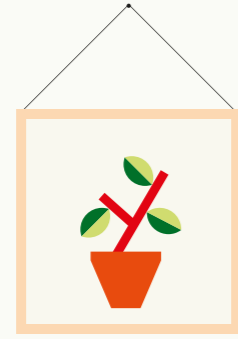

## 217

- > Sedia imbottita con rivestimento in tessuto.
- > Upholstered chair.
- > Chaise rembourrée avec revêtement en tissu.
- > Gepolsterer Stuhl mit Bezug aus Stoff.
- > Silla tapizada.

## 218

- > Maxi-pouf imbottito con rivestimento in tessuto.
- > Upholstered Maxi-pouf.
- > Maxi-pouf rembourrée avec revêtement en tissu.
- > Gepolsterer Maxi-Hocker mit Bezug aus Stoff.
- > Maxi-Pouf tapizado.

## 219

- > Pouf imbottito con rivestimento in tessuto.
- > Upholstered pouf.
- > Pouf rembourrée.
- > Gepolsterer Hocker.
- > Pouf tapizado.

## TE

- > Finiture seduta (vedi p. 375)
- > Seat finishes (see p. 375)
- > Finitions de l'assise (voir p. 375)
- > Sitzfertigungen (sehen S. 375)
- > Acabados asiento (ver p. 375)

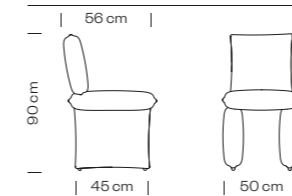

Peso / Weight / Poids / Gewicht / Peso **6,2 Kg**

Imballo / Packaging / Emballage / Verpackung / Embalaje **0,26 m³**

Pezzi per scatola / Pieces for box / Pièces par carton / Stücke in einem Karton / Piezas por caja **1**

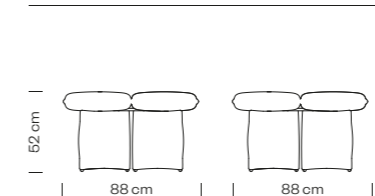
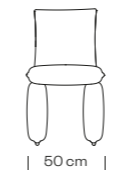

Peso / Weight / Poids / Gewicht / Peso **11,5 Kg**

Imballo / Packaging / Emballage / Verpackung / Embalaje **0,67 m³**

Pezzi per scatola / Pieces for box / Pièces par carton / Stücke in einem Karton / Piezas por caja **1**

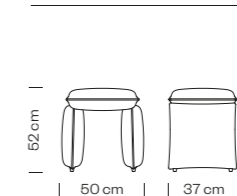

Peso / Weight / Poids / Gewicht / Peso **5,1 Kg**

Imballo / Packaging / Emballage / Verpackung / Embalaje **0,12 m³**

Pezzi per scatola / Pieces for box / Pièces par carton / Stücke in einem Karton / Piezas por caja **1**



# hull

design  
**Harri Koskinen**

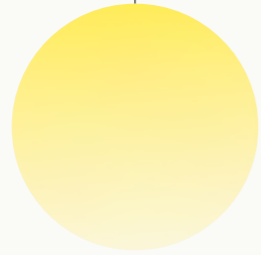









## AC

- > Finiture telaio (vedi p. 397)
- > Frame finishes (see p. 397)
- > Finitions piètement (voir p. 397)
- > Gestell Fertigungen (sehen S. 397)
- > Acabados estructura (ver p. 397)

## LE

- > Finiture seduta  
Legno faggio (finitura gofrata)
- > Seat finishes  
Beech wood (embossed finish)
- > Finitions piètement  
Finition gofré
- > Sitzfertigungen  
Buchenholz (geprägte Ausführung)
- > Acabados estructura  
Gofrado



## TE

- > Finiture seduta (vedi p. 375)
- > Seat finishes (see p. 375)
- > Finitions de l'assise (voir p. 375)
- > Sitzfertigungen (sehen S. 375)
- > Acabados asiento (ver p. 375)



## 627M

- > Sedia con telaio 4 gambe in tubo acciaio, seduta e schienale imbottiti, rivestimento in tessuto.
- > Chair with 4 legs steel frame. Upholstered seat and back.
- > Chaise avec châssis 4 pieds en acier, assise et dossier rembourrés.
- > Stuhl mit gepolsterten Sitzfläche und Rückenlehne, mit 4-beinigem Stahlgestell.
- > Silla 4 patas en tubular de acero, asiento y respaldo tapizado.



## 628M

- > Sedia con telaio 4 gambe in tubo acciaio, con braccioli, seduta e schienale imbottiti, rivestimento in tessuto.
- > Chair with armrests and steel frame, 4 legs. Upholstered seat and back.
- > Chaise avec châssis 4 pieds en acier, avec accoudoirs, assise et dossier rembourrés.
- > Armlehnstuhl mit gepolsterten Sitzfläche und Rückenlehne, mit 4-beinigem Stahlgestell.
- > Sillón 4 patas en tubular de acero, asiento y respaldo tapizado.



## 629M

- > Sedia con telaio 4 gambe in tubo acciaio, con braccioli, seduta e schienale imbottiti, rivestimento in tessuto.
- > Chair with armrests and steel frame, 4 legs. Upholstered seat and back.
- > Chaise avec châssis 4 pieds en acier, avec accoudoirs, assise et dossier rembourrés.
- > Armlehnstuhl mit gepolsterten Sitzfläche und Rückenlehne, mit 4-beinigem Stahlgestell.
- > Sillón 4 patas en tubular de acero, asiento y respaldo tapizado.



## 630

- > Sgabello con telaio 4 gambe in tubo acciaio, seduta in faggio (finitura gofrata).
- > Barstool with 4 legs steel frame. Beech wood seat (embossed finish).
- > Tabouret avec châssis 4 pieds en acier. Assise et dossier en hêtre (finition goffré).
- > Barhocker mit gepolsterten Sitzfläche und Rückenlehne aus Buchenholz (geprägte Ausführung).
- > Taburete 4 patas en tubular de acero, asiento en haya (gofrado).



## 630M

- > Sgabello con telaio 4 gambe in tubo acciaio, seduta imbottita, rivestimento in tessuto.
- > Barstool with 4 legs steel frame. Upholstered seat.
- > Tabouret avec châssis 4 pieds en acier, assise et dossier rembourrés.
- > Barhocker mit gepolsterten Sitzfläche und Rückenlehne, mit 4-beinigem Stahlgestell.
- > Taburete 4 patas en tubular de acero, asiento tapizado.



## 627

- > Sedia con telaio 4 gambe in tubo acciaio, seduta e schienale in faggio (finitura gofrata).
- > Chair with 4 legs steel frame. Beech wood seat and back (embossed finish).
- > Chaise avec châssis 4 pieds en acier, assise et dossier en hêtre (finition goffré).
- > Stuhl mit Sitzfläche und Rückenlehne aus Buchenholz (Ausführung geprägt), mit 4-beinigem Stahlgestell.
- > Silla 4 patas en tubular de acero, asiento y respaldo en haya (gofrado).



## 628

- > Sedia con telaio 4 gambe in tubo acciaio, con braccioli, seduta e schienale in faggio (finitura gofrata).
- > Chair with armrests and steel frame, 4 legs. Beech wood seat and back (embossed finish).
- > Chaise avec châssis 4 pieds en acier, avec accoudoirs, assise et dossier en hêtre (finition goffré).
- > Armlehnstuhl mit Sitzfläche und Rückenlehne aus Buchenholz (Ausführung geprägt), mit 4-beinigem Stahlgestell.
- > Sillón 4 patas en tubular de acero, asiento y respaldo en haya (gofrado).



## 629

- > Sedia con telaio 4 gambe in tubo acciaio, con braccioli, seduta e schienale in faggio (finitura gofrata).
- > Chair with armrests and steel frame, 4 legs. Beech wood seat and back (embossed finish).
- > Chaise avec châssis 4 pieds en acier, avec accoudoirs, assise et dossier en hêtre (finition goffré).
- > Armlehnstuhl mit Sitzfläche und Rückenlehne aus Buchenholz (Ausführung geprägt), mit 4-beinigem Stahlgestell.
- > Sillón 4 patas en tubular de acero, asiento y respaldo en haya (gofrado).

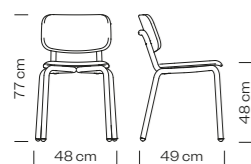

Peso / Weight / Poids / Gewicht / Peso **5,6 Kg**

Imballo / Packaging / Emballage / Verpackung / Embalaje **0,39 m<sup>3</sup>**

Pezzi per scatola / Pieces for box / Pièces par carton / Stücke in einem Karton / Piezas por caja **1**

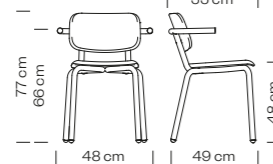

Peso / Weight / Poids / Gewicht / Peso **6,1 Kg**

Imballo / Packaging / Emballage / Verpackung / Embalaje **0,45 m<sup>3</sup>**

Pezzi per scatola / Pieces for box / Pièces par carton / Stücke in einem Karton / Piezas por caja **1**

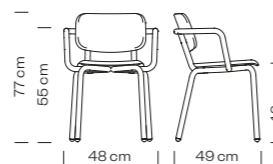

Peso / Weight / Poids / Gewicht / Peso **6,9 Kg**

Imballo / Packaging / Emballage / Verpackung / Embalaje **0,45 m<sup>3</sup>**

Pezzi per scatola / Pieces for box / Pièces par carton / Stücke in einem Karton / Piezas por caja **1**



Peso / Weight / Poids / Gewicht / Peso **5 Kg**

Imballo / Packaging / Emballage / Verpackung / Embalaje **0,29 m<sup>3</sup>**

Pezzi per scatola / Pieces for box / Pièces par carton / Stücke in einem Karton / Piezas por caja **2**

Impilabile / Stackable / Empilable / Stapelbar / Apilable **2**

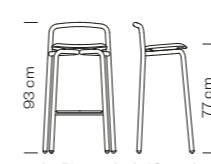

Peso / Weight / Poids / Gewicht / Peso **5,2 Kg**

Imballo / Packaging / Emballage / Verpackung / Embalaje **0,29 m<sup>3</sup>**

Pezzi per scatola / Pieces for box / Pièces par carton / Stücke in einem Karton / Piezas por caja **1**

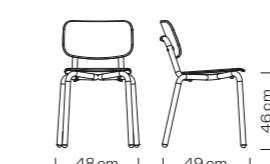

Peso / Weight / Poids / Gewicht / Peso **5,2 kg**

Imballo / Packaging / Emballage / Verpackung / Embalaje **0,39 m<sup>3</sup>**

Pezzi per scatola / Pieces for box / Pièces par carton / Stücke in einem Karton / Piezas por caja **4**

Impilabile / Stackable / Empilable / Stapelbar / Apilable **4**

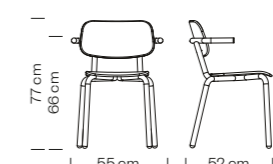

Peso / Weight / Poids / Gewicht / Peso **5,7 kg**

Imballo / Packaging / Emballage / Verpackung / Embalaje **0,45 m<sup>3</sup>**

Pezzi per scatola / Pieces for box / Pièces par carton / Stücke in einem Karton / Piezas por caja **4**

Impilabile / Stackable / Empilable / Stapelbar / Apilable **4**

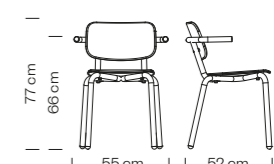

Peso / Weight / Poids / Gewicht / Peso **6,4 kg**

Imballo / Packaging / Emballage / Verpackung / Embalaje **0,45 m<sup>3</sup>**

Pezzi per scatola / Pieces for box / Pièces par carton / Stücke in einem Karton / Piezas por caja **4**

Impilabile / Stackable / Empilable / Stapelbar / Apilable **4**

# shade

design  
**Philippe Nigro**











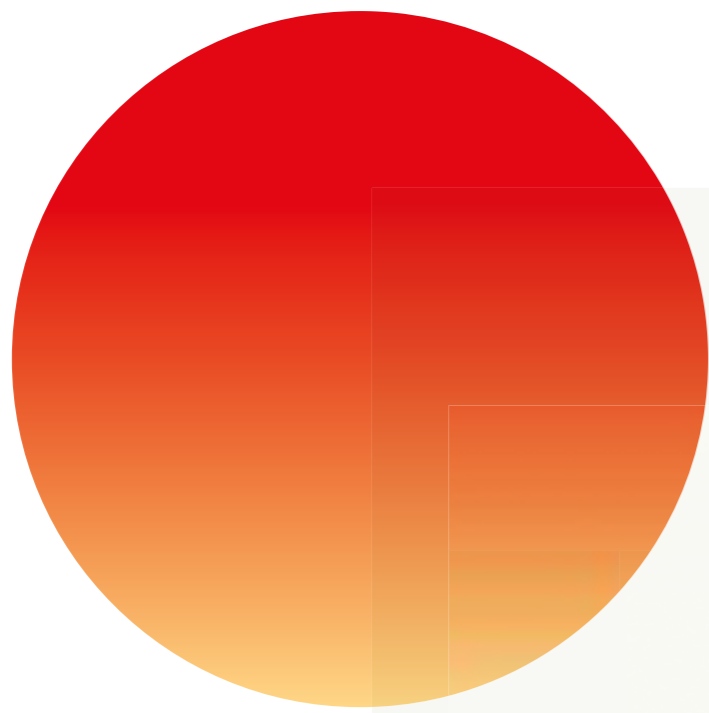



- > Finiture seduta  
(vedi p. 397)
- > Seat finishes  
(see p. 397)
- > Finitions de l'assise  
(voir p. 397)
- > Sitzfertigung  
(sehen S. 397)
- > Acabados asiento  
(ver p. 397)

**Accessori / Accessories /  
Accessoires / Zubehoer /  
Accesorios**

- > Cuscino in tessuto impermeabile  
per esterno (da rimuovere in caso  
di pioggia)
- > Waterproof fabric cushion for  
outdoors (to be removed in case of  
bad weather)
- > Coussin en tissu imperméable  
pour l'extérieur (à retirer en cas de  
intempéries)
- > Kissen Wasserdichtes Gewebe für  
den Außenbereich (im Falle von  
Regen zu entfernen)
- > Cojín en tejido impermeable para  
exteriores (por removerse en caso  
de lluvia)

**Finiture / Finishes /  
Finitions / Fertigungen /  
Acabados**



1004 Bruma Grafito



1007 Bruma Niebla





## 619

- > Poltrona lounge con telaio a 4 gambe in tubo di acciaio. Seduta e schienale in tondino d'acciaio.
- > Lounge armchair with 4 legs steel frame. Seat and back in steel frame.
- > Fauteuil lounge avec structure en acier à 4 pieds. Assise et dossier dans un cadre en acier.
- > Lounge Sessel mit 4-beinigem Stahlgestell. Sitzfläche und Rückenlehne aus elektroverschweißten Stahlrohren.
- > Sillón lounge con estructura tubular 4 patas en acero. Asiento y respaldo en acero.



## 632

- > Tavolino con telaio in tubo d'acciaio. Versione H 42 cm. Piano in lamiera acciaio 44x43 cm.
- > Coffee table with steel frame. Version H 42 cm. Top in sheet steel 44x43 cm.
- > Table basse avec châssis en acier. Version H 42 cm. Plateau en tôle d'acier 44x43 cm.
- > Couchtisch mit Stahlgestell. Ausführung H 42 cm. Tischplatte aus Stahlblech 44x43 cm.
- > Mesa auxiliar con estructura de acero, altura 42 cm. Encimera en chapa de acero 44x43 cm.



## 632B

- > Tavolino con telaio in tubo d'acciaio. Versione H 30 cm. Piano in lamiera acciaio 44x43 cm.
- > Coffee table with steel frame. Version H 30 cm. Top in sheet steel 44x43 cm.
- > Table basse avec châssis en acier. Version H 30 cm. Plateau en tôle d'acier 44x43 cm.
- > Couchtisch mit Stahlgestell. Ausführung H 30 cm. Tischplatte aus Stahlblech 44x43 cm.
- > Mesa auxiliar con estructura de acero, altura 30 cm. Encimera en chapa de acero 44x43 cm.



## 625

- > Sedia con telaio a 4 gambe in tubo acciaio. Seduta e schienale in tondino acciaio.
- > Chair with 4 legs steel frame. Seat and back in steel frame.
- > Chaise avec châssis 4 pieds en acier. Assise et dossier en fil d'acier.
- > Stuhl mit 4-beinigem Stahlgestell. Sitzfläche und Rückenlehne aus elektroverschweißten Stahlrohren.
- > Silla con estructura tubular 4 patas en acero. Asiento y respaldo en acero.



## 626

- > Sedia con telaio a 4 gambe in tubo acciaio. Seduta e schienale in tondino acciaio.
- > Chair with 4 legs steel frame. Seat and back in steel frame.
- > Chaise avec châssis 4 pieds en acier. Assise et dossier en fil d'acier.
- > Stuhl mit 4-beinigem Stahlgestell. Sitzfläche und Rückenlehne aus elektroverschweißten Stahlrohren.
- > Silla con estructura tubular 4 patas en acero. Asiento y respaldo en acero.



## 624

- > Sgabello con telaio a 4 gambe in tubo acciaio. Seduta e schienale in tondino acciaio.
- > Barstool with 4 legs steel frame. Seat and back in steel frame.
- > Tabouret avec châssis 4 pieds en acier. Assise et dossier en fil d'acier. Disponible versions hauteur assise 75.
- > Barhocker mit 4-beinigem Stahlgestell. Sitzfläche und Rückenlehne aus elektroverschweißten Stahlrohren. Verfügbar Sitzhöhe 75.
- > Taburete con estructura tubular 4 patas en acero. Asiento y respaldo en acero. Versiones disponibles altura asiento 75.



## 624B

- > Sgabello con telaio a 4 gambe in tubo acciaio. Seduta e schienale in tondino acciaio. Seduta: H 65 cm.
- > Barstool with 4 legs steel frame. Seat and back in steel frame. Seat height: H 65.
- > Tabouret avec châssis 4 pieds en acier. Assise et dossier en fil d'acier. Hauteur assise: H 65 cm.
- > Barhocker mit 4-beinigem Stahlgestell. Sitzfläche und Rückenlehne aus elektroverschweißten Stahlrohren. Sitzhöhe: H 65 cm.
- > Taburete con estructura tubular 4 patas en acero. Asiento y respaldo en acero. Altura asiento 65 cm.

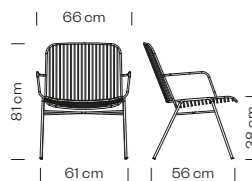

Peso / Weight / Poids / Gewicht / Peso **9,2 kg**

Imballo / Packaging / Emballage / Verpackung / Embalaje **0,50 m³**

Pezzi per scatola / Pieces for box / Pièces par carton / Stücke in einem Karton / Piezas por caja **2**

Impilabile / Stackable / Empilable / Stapelfähigkeit / Apilable **2**

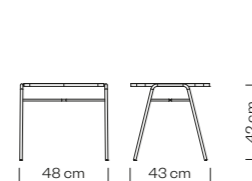

Peso / Weight / Poids / Gewicht / Peso **4 kg**

Imballo / Packaging / Emballage / Verpackung / Embalaje **0,16 m³**

Pezzi per scatola / Pieces for box / Pièces par carton / Stücke in einem Karton / Piezas por caja **2**

Impilabile / Stackable / Empilable / Stapelfähigkeit / Apilable **2**

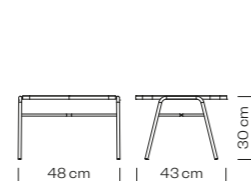

Peso / Weight / Poids / Gewicht / Peso **3,8 kg**

Imballo / Packaging / Emballage / Verpackung / Embalaje **0,13 m³**

Pezzi per scatola / Pieces for box / Pièces par carton / Stücke in einem Karton / Piezas por caja **2**

Impilabile / Stackable / Empilable / Stapelfähigkeit / Apilable **2**

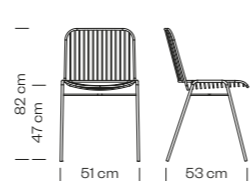

Peso / Weight / Poids / Gewicht / Peso **6,3 kg**

Imballo / Packaging / Emballage / Verpackung / Embalaje **0,37 m³**

Pezzi per scatola / Pieces for box / Pièces par carton / Stücke in einem Karton / Piezas por caja **4**

Impilabile / Stackable / Empilable / Stapelfähigkeit / Apilable **8**

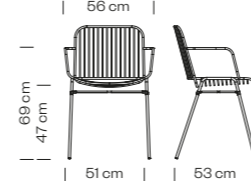

Peso / Weight / Poids / Gewicht / Peso **7,2 kg**

Imballo / Packaging / Emballage / Verpackung / Embalaje **0,39 m³**

Pezzi per scatola / Pieces for box / Pièces par carton / Stücke in einem Karton / Piezas por caja **4**

Impilabile / Stackable / Empilable / Stapelfähigkeit / Apilable **8**

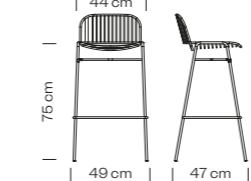

Peso / Weight / Poids / Gewicht / Peso **6,8 kg**

Imballo / Packaging / Emballage / Verpackung / Embalaje **0,37 m³**

Pezzi per scatola / Pieces for box / Pièces par carton / Stücke in einem Karton / Piezas por caja **2**

Impilabile / Stackable / Empilable / Stapelfähigkeit / Apilable **6**

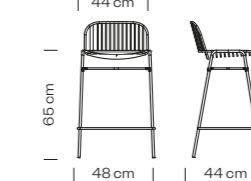

Peso / Weight / Poids / Gewicht / Peso **6,6 kg**

Imballo / Packaging / Emballage / Verpackung / Embalaje **0,28 m³**

Pezzi per scatola / Pieces for box / Pièces par carton / Stücke in einem Karton / Piezas por caja **2**

Impilabile / Stackable / Empilable / Stapelfähigkeit / Apilable **6**

# palau

design  
**Marc Sadler**









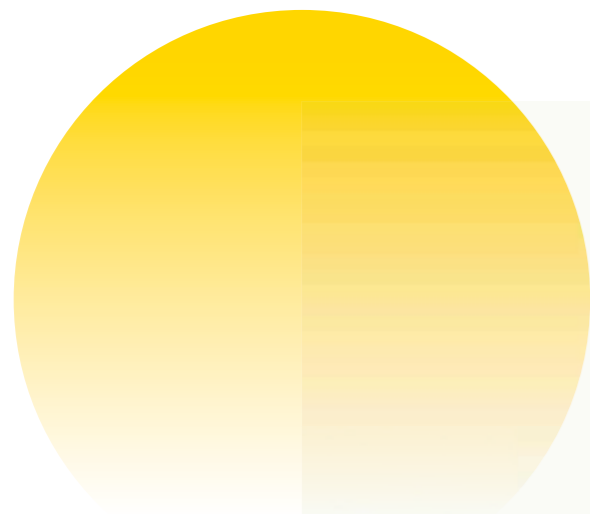

## 1020

- > Sedia monoblocco in polipropilene, stampata a iniezione con tecnologia air moulding.
- > Monobloc chair in polypropylene made using the injected airmoulding technology.
- > Chaise en polypropylène monobloc, moulée sous injection avec gaz air moulding.
- > Stuhl aus nur einem einzigen Teil aus Polypropylen, mit der Air-Moulding-Technologie injektionsgepresst.
- > Silla monobloque en polipropileno moldeada por inyección con tecnología air moulding.

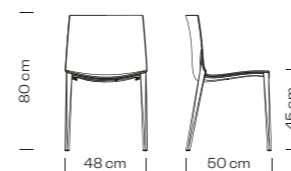

Peso / Weight / Poids / Gewicht / Peso **3,8 kg**

Imballo / Packaging / Emballage / Verpackung / Embalaje **0,31 m<sup>3</sup>**

Pezzi per scatola / Pieces for box / Pièces par carton / Stücke in einem Karton / Piezas por caja **4**

Impilabile / Stackable / Empilable / Stapelbar / Apilable **6**



## 1021

- > Sedia monoblocco con braccioli in polipropilene, stampata a iniezione con tecnologia air moulding.
- > Monobloc armchair in polypropylene made using the injected air-moulding technology.
- > Fauteuil en polypropylène monobloc, moulée sous injection avec gaz air moulding.
- > Armlehnstuhl aus nur einem einzigen Teil aus Polypropylen, mit der Air-Moulding-Technologie injektionsgepresst.
- > Silla monobloque en polipropileno con brazos moldeada por inyección con tecnología air moulding.

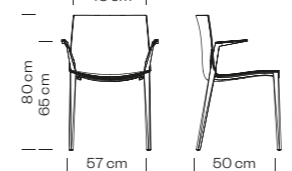

Peso / Weight / Poids / Gewicht / Peso **4,1 kg**

Imballo / Packaging / Emballage / Verpackung / Embalaje **0,36 m<sup>3</sup>**

Pezzi per scatola / Pieces for box / Pièces par carton / Stücke in einem Karton / Piezas por caja **4**

Impilabile / Stackable / Empilable / Stapelbar / Apilable **6**

## PP

- > Finiture seduta
- > Seat finishes
- > Finitions de l'assise
- > Sitzfertigungen
- > Acabados asiento





# myra

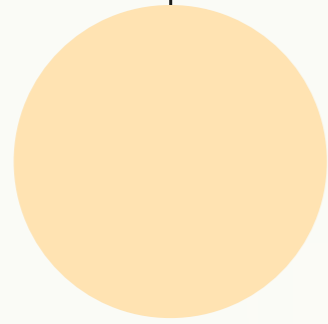

design  
**Emilio Nanni**

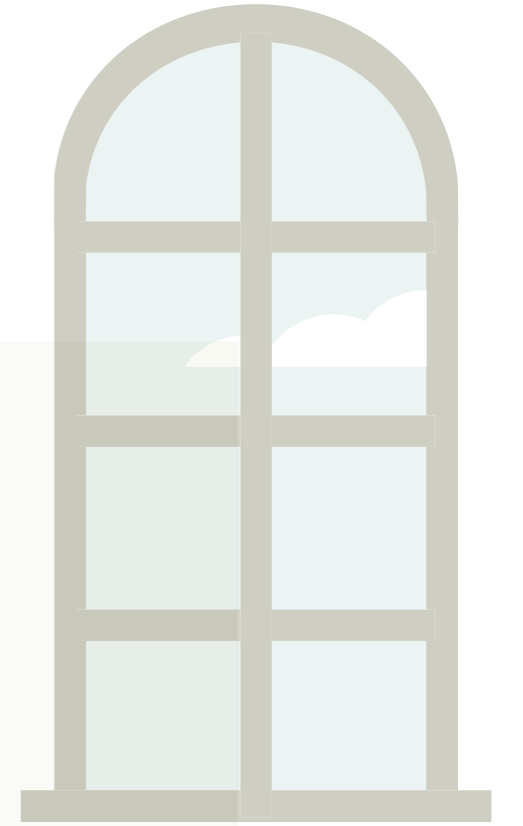

reddot award 2017  
winner















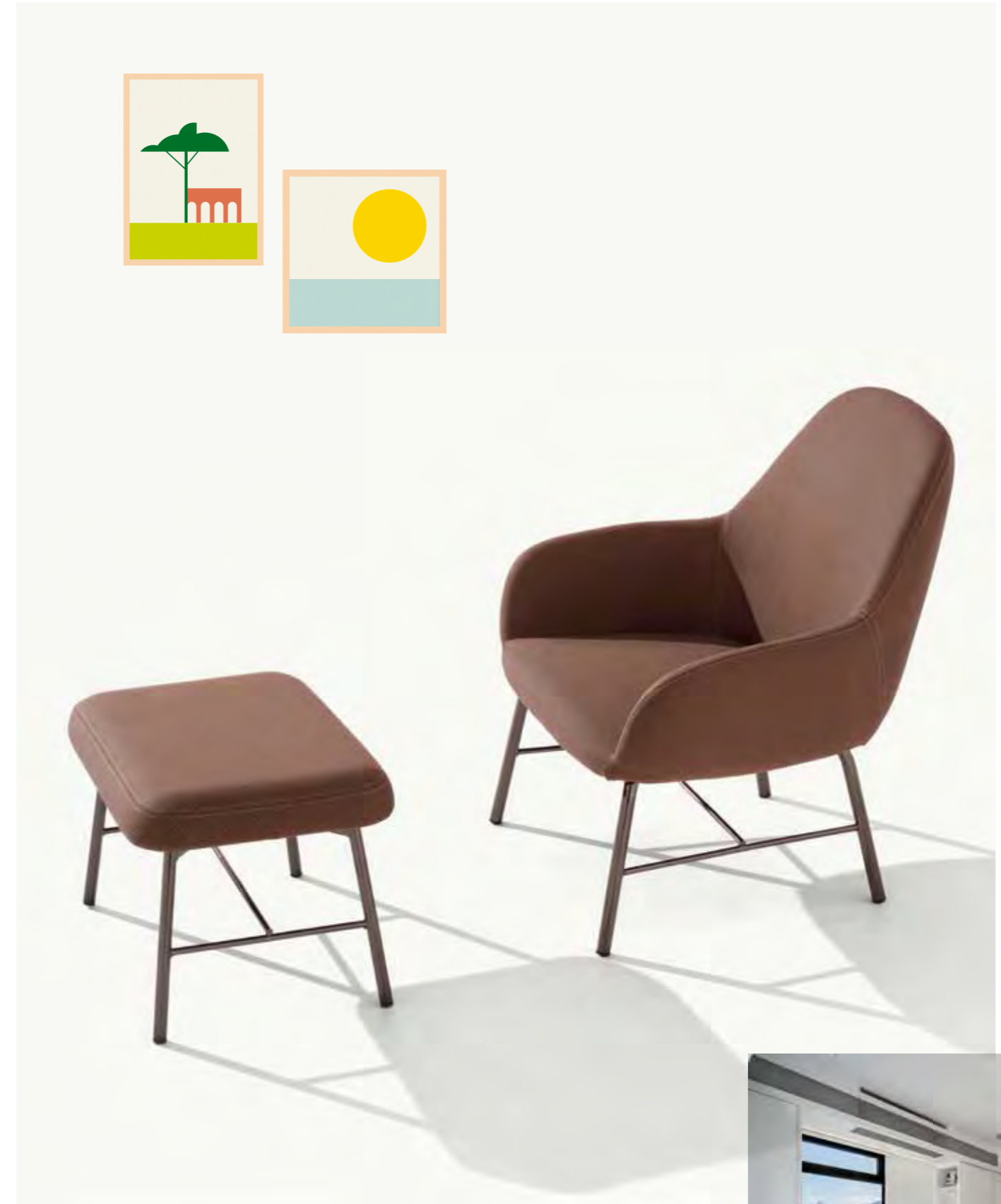



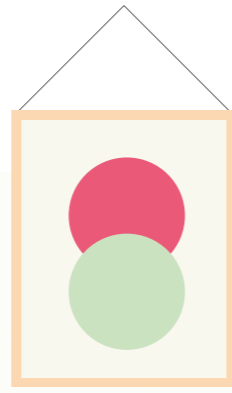



652

- > Sedia con seduta e schienale imbottiti, rivestimento in tessuto, telaio 4 gambe in tubo acciaio.
- > Chair with 4 legs steel frame, upholstered seat and back.
- > Chaise avec assise et dossier rembourrés, revêtement en tissu, châssis 4 pieds en acier.
- > Stuhl mit gepolsterten Sitzfläche und Rückenlehne. Bezug aus Stoff. 4-beinigem Stahlgestell.
- > Silla con estructura tubular 4 patas en acero. Asiento y respaldo tapizados.



653

- > Poltroncina con seduta e schienale imbottiti, rivestimento in tessuto, telaio 4 gambe in tubo acciaio.
- > Armchair with 4 legs steel frame, upholstered seat and back.
- > Fauteuil avec assise et dossier rembourrés, revêtement en tissu, châssis 4 pieds en acier.
- > Armlehnstuhl mit gepolsterten Sitzfläche und Rückenlehne. Bezug aus Stoff. 4-beinigem Stahlgestell.
- > Sillón con estructura tubular 4 patas en acero. Asiento y respaldo tapizados.



654

- > Sgabello con seduta e schienale imbottiti, rivestimento in tessuto, telaio 4 gambe in tubo acciaio.
- > Barstool with 4 legs steel frame, upholstered seat and back.
- > Tabouret avec assise et dossier rembourrés, revêtement en tissu, châssis 4 pieds en acier.
- > Barhocker mit gepolsterten Sitzfläche und Rückenlehne. Bezug aus Stoff. 4-beinigem Stahlgestell.
- > Taburete con estructura tubular 4 patas en acero. Asiento y respaldo tapizados.



654B

- > Sgabello con seduta e schienale imbottiti, rivestimento in tessuto, telaio 4 gambe in tubo acciaio. Versione con altezza seduta H 65 cm.
- > Barstool with 4 legs steel frame, upholstered seat and back. Version with seat-height H 65 cm.
- > Tabouret avec assise et dossier rembourrés, revêtement en tissu, châssis 4 pieds en acier. Version avec hauteur assise 65 cm.
- > Barhocker mit gepolsterten Sitzfläche und Rückenlehne. Bezug aus Stoff. 4-beinigem Stahlgestell. Sitzhöhe 65 cm.
- > Taburete con estructura tubular 4 patas en acero. Asiento y respaldo tapizados. Altura asiento 65 cm.



655

- > Poltrona lounge con seduta e schienale imbottiti, rivestimento in tessuto, telaio 4 gambe in acciaio.
- > Lounge armchair with 4 legs steel frame and upholstered seat and back.
- > Fauteuil lounge avec assise et dossier rembourrés, revêtement en tissu, châssis 4 pieds en acier.
- > Loungesessel mit gepolsterten Sitzfläche und Rückenlehne. Bezug aus Stoff. 4-beinigem Stahlgestell.
- > Sillón lounge con estructura tubular 4 patas en acero. Asiento y respaldo tapizados.



676

- > Poltrona lounge con seduta e schienale imbottiti, rivestimento in tessuto, telaio a basamento centrale girevole.
- > Swivel lounge armchair with central steel base. Upholstered seat and back.
- > Fauteuil lounge avec pivotement central pivotant en acier, assise et dossier rembourrés, revêtement en tissu.
- > Lounge Sessel mit drehbaren Untergestell und mittlerem Standfuss aus Stahl. Gepolsterte Sitzfläche und Rückenlehne.
- > Sillón lounge con asiento y respaldo tapizados, estructura columna central giratoria.



677

- > Poltrona lounge con seduta e schienale imbottiti, rivestimento in tessuto, telaio 4 razze in alluminio, girevole, con meccanismo di ritorno.
- > Swivel lounge chair with 4 legs steel frame and upholstered seat and back, 4 ways aluminium frame. Return mechanism.
- > Fauteuil lounge pivotante avec assise et dossier rembourrés, revêtement en tissu, châssis en aluminium 4 branches. Avec mécanisme de retour.
- > Lounge Sessel mit 4-armigem drehbaren Fusskreuz aus Aluminium. Gepolsterte Sitzfläche und Rückenlehne. Automatischer zurück System.
- > Sillón lounge con asiento y respaldo tapizados, estructura 4 radios en aluminio, giratoria.



678

- > Poltroncina con seduta e schienale imbottiti, rivestimento in tessuto, telaio 4 razze in alluminio, girevole.
- > Swivel armchair with 4 legs steel frame and upholstered seat and back, 4 ways aluminium frame.
- > Chair lounge pivotante avec assise et dossier rembourrés, revêtement en tissu, châssis en aluminium 4 branches.
- > Armlehnstuhl mit 4-armigem drehbaren Fusskreuz aus Aluminium. Gepolsterte Sitzfläche und Rückenlehne.
- > Sillón con asiento y respaldo tapizados, estructura 4 radios en aluminio, giratoria.

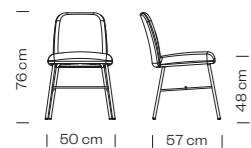

Peso / Weight / Poids / Gewicht / Peso **7,1 kg**

Imballo / Packaging / Emballage / Verpackung / Embalaje **0,33 m³**

Pezzi per scatola / Pieces per box / Pièces par carton / Stücke in einem Karton / Piezas por caja **2**



Peso / Weight / Poids / Gewicht / Peso **9 kg**

Imballo / Packaging / Emballage / Verpackung / Embalaje **0,32 m³**

Pezzi per scatola / Pieces per box / Pièces par carton / Stücke in einem Karton / Piezas por caja **1**

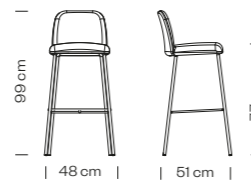

Peso / Weight / Poids / Gewicht / Peso **7,7 kg**

Imballo / Packaging / Emballage / Verpackung / Embalaje **0,28 m³**

Pezzi per scatola / Pieces per box / Pièces par carton / Stücke in einem Karton / Piezas por caja **1**



Peso / Weight / Poids / Gewicht / Peso **7,1 kg**

Imballo / Packaging / Emballage / Verpackung / Embalaje **0,24 m³**

Pezzi per scatola / Pieces per box / Pièces par carton / Stücke in einem Karton / Piezas por caja **1**

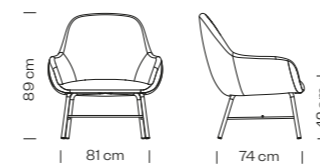

Peso / Weight / Poids / Gewicht / Peso **16 kg**

Imballo / Packaging / Emballage / Verpackung / Embalaje **0,60 m³**

Pezzi per scatola / Pieces per box / Pièces par carton / Stücke in einem Karton / Piezas por caja **1**

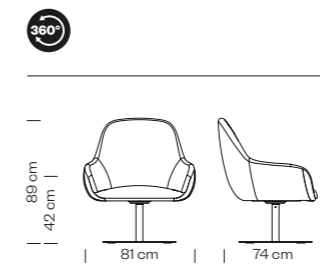

Peso / Weight / Poids / Gewicht / Peso **30,1 kg**

Imballo / Packaging / Emballage / Verpackung / Embalaje **0,60 m³**

Pezzi per scatola / Pieces per box / Pièces par carton / Stücke in einem Karton / Piezas por caja **1**

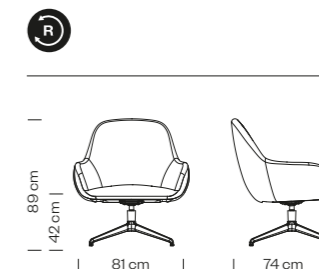

Peso / Weight / Poids / Gewicht / Peso **19,6 kg**

Imballo / Packaging / Emballage / Verpackung / Embalaje **0,60 m³**

Pezzi per scatola / Pieces per box / Pièces par carton / Stücke in einem Karton / Piezas por caja **1**

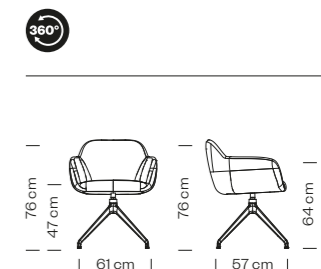

Peso / Weight / Poids / Gewicht / Peso **11,6 kg**

Imballo / Packaging / Emballage / Verpackung / Embalaje **0,32 m³**

Pezzi per scatola / Pieces per box / Pièces par carton / Stücke in einem Karton / Piezas por caja **1**



# 679

- > Divano con seduta e schienale imbottiti, rivestimento in tessuto, telaio 4 gambe in tubo acciaio.
- > Sofa with upholstered seat and back, steel frame, 4 legs.
- > Canapé avec assise et dossier rembourrés, revêtement en tissu, châssis 4 pieds en acier.
- > Sofa mit 4-beinigem Stahlgestell. Gepolsterte Sitzfläche und Rückenlehne.
- > Sofá con asiento y respaldo tapizados, estructura tubular 4 patas en acero.

# 680

- > Divano con seduta e schienale imbottiti, rivestimento in tessuto, telaio 4 gambe in faggio.
- > Sofa with upholstered seat and back, 4 beech wood legs.
- > Canapé avec assise et dossier rembourrés, revêtement en tissu, châssis 4 pieds en hêtre.
- > Sofa mit 4-beinigem Buchenholzgestell. Gepolsterte Sitzfläche und Rückenlehne.
- > Sofá con asiento y respaldo tapizados, estructura 4 patas en madera de haya.

# 660

- > Pouf imbottito con telaio 4 gambe in tubo acciaio.
- > Upholstered pouf with 4 legs steel frame.
- > Pouf rembourrée, avec châssis 4 pieds en acier.
- > Gepolsterter Hocker mit 4-beinigem Stahlgestell.
- > Pouf tapizado con estructura tubular 4 patas en acero.

# 681

- > Poltrona bergère con seduta e schienale imbottiti, rivestimento in tessuto, telaio 4 gambe in tubo acciaio.
- > Wing chair with upholstered seat and back, steel frame, 4 legs.
- > Fauteuil bergère avec assise et dossier rembourrés, revêtement en tissu, châssis 4 pieds en hêtre.
- > Ohrensessel mit 4-beinigem Stahlgestell. Gepolsterte Sitzfläche und Rückenlehne.
- > Sillón bergere con asiento y respaldo tapizados, estructura tubular 4 patas en acero.

# 682

- > Poltrona bergère con seduta e schienale imbottiti, rivestimento in tessuto, telaio 4 gambe in faggio.
- > Wing chair with upholstered seat and back, 4 beech wood legs.
- > Fauteuil bergère avec assise et dossier rembourrés, revêtement en tissu, châssis 4 pieds en hêtre.
- > Ohrensessel mit 4-beinigem Buchenholzgestell. Gepolsterte Sitzfläche und Rückenlehne.
- > Sillón bergere con asiento y respaldo tapizados, estructura 4 patas en madera de haya.

# 683

- > Poltrona bergère con seduta e schienale imbottiti, rivestimento in tessuto, telaio 4 razze in alluminio, girevole.
- > Swivel wing chair with upholstered seat and back, 4 ways aluminium frame.
- > Fauteuil bergère pivotante avec assise et dossier rembourrés, revêtement en tissu, châssis en aluminium 4 branches.
- > Ohrensessel mit 4-armigem drehbaren Fusskreuz aus Aluminium. Gepolsterte Sitzfläche und Rückenlehne.
- > Sillón bergere con asiento y respaldo tapizados, estructura 4 radios en aluminio, giratoria.

# 656

- > Sedia con seduta e schienale imbottiti, rivestimento in tessuto, telaio 4 gambe in faggio.
- > Chair with beech wood frame, 4 legs. Upholstered seat and back.
- > Chaise avec assise et dossier rembourrés, revêtement en tissu, châssis 4 pieds en hêtre.
- > Stuhl mit gepolsterten Sitzfläche und Rückenlehne. Bezug aus Stoff. 4-beinigem Buchenholzgestell.
- > Silla con estructura 4 patas en madera de haya. Asiento y respaldo tapizados.

# 657

- > Poltroncina con seduta e schienale imbottiti, rivestimento in tessuto, telaio 4 gambe in faggio.
- > Armchair with beech wood frame, 4 legs. Upholstered seat and back.
- > Fauteuil avec assise et dossier rembourrés, revêtement en tissu, châssis 4 pieds en hêtre.
- > Armlehnstuhl mit gepolsterten Sitzfläche und Rückenlehne. Bezug aus Stoff. 4-beinigem Buchenholzgestell.
- > Sillón con estructura 4 patas en madera de haya. Asiento y respaldo tapizados.

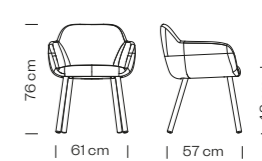
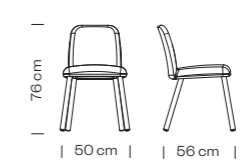
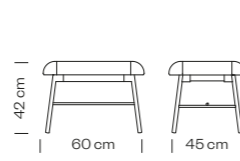
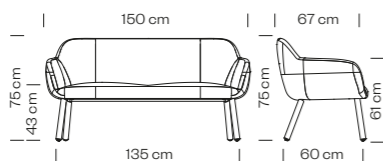
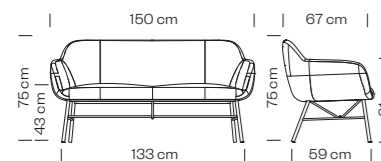

Peso / Weight / Poids / Gewicht / Peso **31,8 kg**

Peso / Weight / Poids / Gewicht / Peso **30,5 kg**

Peso / Weight / Poids / Gewicht / Peso **6,7 kg**

Peso / Weight / Poids / Gewicht / Peso **21,8 kg**

Peso / Weight / Poids / Gewicht / Peso **21,3 kg**

Peso / Weight / Poids / Gewicht / Peso **25,2 kg**

Peso / Weight / Poids / Gewicht / Peso **6,9 kg**

Peso / Weight / Poids / Gewicht / Peso **8,8 kg**

Imballo / Packaging / Emballage / Verpackung / Embalaje **0,89 m³**

Imballo / Packaging / Emballage / Verpackung / Embalaje **0,89 m³**

Imballo / Packaging / Emballage / Verpackung / Embalaje **0,16 m³**

Imballo / Packaging / Emballage / Verpackung / Embalaje **0,75 m³**

Imballo / Packaging / Emballage / Verpackung / Embalaje **0,75 m³**

Imballo / Packaging / Emballage / Verpackung / Embalaje **0,75 m³**

Imballo / Packaging / Emballage / Verpackung / Embalaje **0,33 m³**

Imballo / Packaging / Emballage / Verpackung / Embalaje **0,32 m³**

Pezzi per scatola / Pieces per box / Pièces par carton / Stücke in einem Karton / Piezas por caja **1**

Pezzi per scatola / Pieces per box / Pièces par carton / Stücke in einem Karton / Piezas por caja **1**

Pezzi per scatola / Pieces per box / Pièces par carton / Stücke in einem Karton / Piezas por caja **1**

Pezzi per scatola / Pieces per box / Pièces par carton / Stücke in einem Karton / Piezas por caja **1**

Pezzi per scatola / Pieces per box / Pièces par carton / Stücke in einem Karton / Piezas por caja **1**

Pezzi per scatola / Pieces per box / Pièces par carton / Stücke in einem Karton / Piezas por caja **1**

Pezzi per scatola / Pieces per box / Pièces par carton / Stücke in einem Karton / Piezas por caja **2**

Pezzi per scatola / Pieces per box / Pièces par carton / Stücke in einem Karton / Piezas por caja **1**





## 658

- > Sgabello con seduta e schienale imbottiti, rivestimento in tessuto, telaio 4 gambe in faggio.
- > Barstool with beech wood frame, 4 legs. Upholstered seat and back.
- > Tabouret avec assise et dossier rembourrés, revêtement en tissu, châssis 4 pieds en hêtre.
- > Barhocker mit gepolsterten Sitzfläche und Rückenlehne. Bezug aus Stoff. 4-beinigem Buchenholzgestell.
- > Taburete con estructura 4 patas en madera de haya. Asiento y respaldo tapizados.

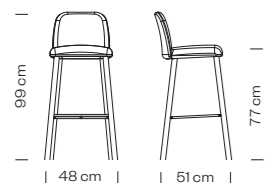

Peso / Weight / Poids / Gewicht / Peso **7,7 kg**

Imballo / Packaging / Emballage / Verpackung / Embalaje **0,28 m³**

Pezzi per scatola / Pieces per box / Pièces par carton / Stücke in einem Karton / Piezas por caja **1**



## 658B

- > Sgabello con seduta e schienale imbottiti, rivestimento in tessuto, telaio 4 gambe in faggio. Versione seduta H 65 cm.
- > Barstool with beech wood frame, 4 legs. Upholstered seat and back. Version seat-height H 65 cm.
- > Tabouret avec assise et dossier rembourrés, revêtement en tissu, châssis 4 pieds en hêtre. Version avec hauteur assise 65 cm.
- > Barhocker mit gepolsterten Sitzfläche und Rückenlehne. Bezug aus Stoff. 4-beinigem Buchenholzgestell. Sitzhöhe 65 cm.
- > Taburete con estructura 4 patas en madera de haya. Asiento y respaldo tapizados. Altura asiento 65 cm.

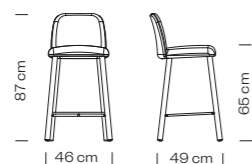

Peso / Weight / Poids / Gewicht / Peso **7,4 kg**

Imballo / Packaging / Emballage / Verpackung / Embalaje **0,24 m³**

Pezzi per scatola / Pieces per box / Pièces par carton / Stücke in einem Karton / Piezas por caja **1**



## 659

- > Poltrona lounge con seduta e schienale imbottiti, rivestimento in tessuto, telaio 4 gambe in faggio.
- > Lounge armchair with beech wood frame, 4 legs. Upholstered seat and back.
- > Fauteuil lounge avec assise et dossier rembourrés, revêtement en tissu, châssis 4 pieds en hêtre.
- > Loungesessel mit gepolsterten Sitzfläche und Rückenlehne. Bezug aus Stoff. 4-beinigem Buchenholzgestell.
- > Sillón lounge con estructura 4 patas en madera de haya. Asiento y respaldo tapizados.

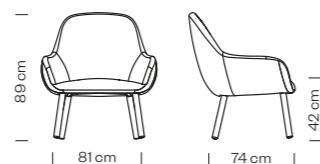

Peso / Weight / Poids / Gewicht / Peso **14,7 kg**

Imballo / Packaging / Emballage / Verpackung / Embalaje **0,60 m³**

Pezzi per scatola / Pieces per box / Pièces par carton / Stücke in einem Karton / Piezas por caja **1**



## 667

- > Panca 1 posto con seduta imbottita, telaio 4 gambe in tubo acciaio.
- > One seat bench with 4 legs steel frame and upholstered seat.
- > Banquette un place avec assise rembourrée et châssis 4 pieds en acier.
- > Bank mit gepolsterter Sitzfläche, 2 Sitzplätze. 4-beinigem Stahlgestell.
- > Banco asiento singulo tapizado, estructura tubular 4 patas en acero.

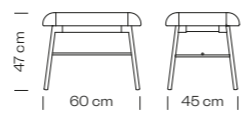

Peso / Weight / Poids / Gewicht / Peso **6,9 kg**

Imballo / Packaging / Emballage / Verpackung / Embalaje **0,16 m³**

Pezzi per scatola / Pieces per box / Pièces par carton / Stücke in einem Karton / Piezas por caja **1**



## 668

- > Panca 2 posti con seduta imbottita, telaio 4 gambe in tubo acciaio.
- > Two seat bench with 4 legs steel frame and upholstered seat.
- > Banquette deux places avec assise rembourrée et châssis 4 pieds en acier.
- > Bank mit gepolsterter Sitzfläche, 2 Sitzplätze. 4-beinigem Stahlgestell.
- > Banco con asiento doble tapizado, estructura tubular 4 patas en acero.

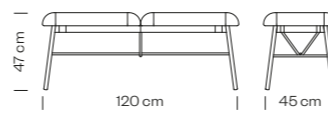

Peso / Weight / Poids / Gewicht / Peso **13 kg**

Imballo / Packaging / Emballage / Verpackung / Embalaje **0,30 m³**

Pezzi per scatola / Pieces per box / Pièces par carton / Stücke in einem Karton / Piezas por caja **1**



## 669

- > Panca 3 posti con seduta imbottita, telaio 4 gambe in tubo acciaio.
- > Three seat bench with 4 legs steel frame and upholstered seat.
- > Banquette trois places avec assise rembourrée et châssis 4 pieds en acier.
- > Bank mit gepolsterter Sitzfläche, 3 Sitzplätze. 4-beinigem Stahlgestell.
- > Banco con asiento triple tapizado, estructura tubular 4 patas en acero.

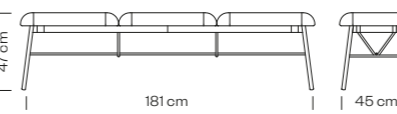

Peso / Weight / Poids / Gewicht / Peso **19 kg**

Imballo / Packaging / Emballage / Verpackung / Embalaje **0,45 m³**

Pezzi per scatola / Pieces per box / Pièces par carton / Stücke in einem Karton / Piezas por caja **1**

## TE

- > Finiture seduta (vedi p. 375)
- > Seat finishes (see p. 375)
- > Finitions de l'assise (voir p. 375)
- > Sitzfertigungen (sehen S. 375)
- > Acabados asiento (ver p. 375)

## AC

- > Finiture seduta (vedi p. 397)
- > Seat finishes (see p. 397)
- > Finitions de l'assise (voir p. 397)
- > Sitzfertigung (sehen S. 397)
- > Acabados asiento (ver p. 397)

## AL PSH

- > Finiture telaio (vedi p. 399)
- > Frame finishes (see p. 399)
- > Finitions piètement (voir p. 399)
- > Gestell fertigungen (sehen S. 399)
- > Acabados estructura (ver p. 399)

## AL VR

- > Finiture telaio
- > Frame finishes
- > Finitions piètement
- > Gestell fertigungen
- > Acabados estructura



## LE

- > Finiture telaio
- > Frame finishes
- > Finitions piètement
- > Gestell fertigungen
- > Acabados estructura

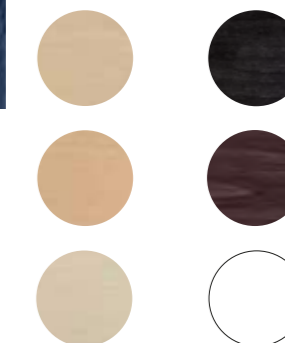

- > Cucitura disponibile nei colori rosso, corda e in tinta.
- > Stichings available in red, rope and according to fabric colour.
- > Couture disponible en coloris rouge, corde (blanc casse) ou en accordance au revêtement.
- > Naht verfügbar in Farben Rot, Seil und im Einklang mit dem Stoff-Farbe.
- > Hilo disponible en los colores rojo, cuerda o en color coordinado con el tejido.

nassau

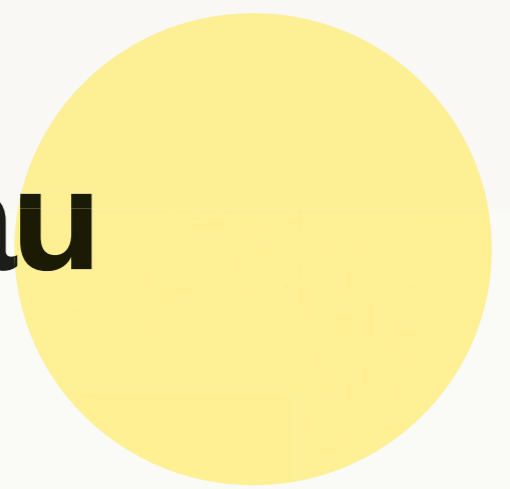

design  
Marc Sadler

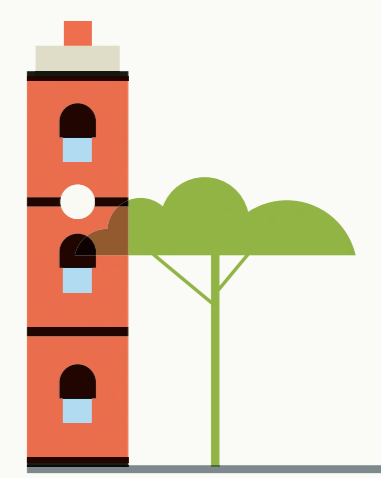

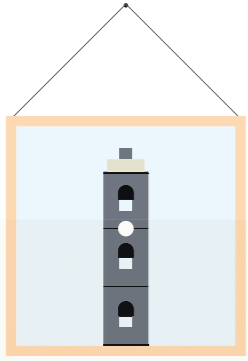





## TE

- > Finiture seduta (vedi p. 375)
- > Seat finishes (see p. 375)
- > Finitions de l'assise (voir p. 375)
- > Sitzfertigungen (sehen S. 375)
- > Acabados asiento (ver p. 375)

## PP

- > Finiture seduta
- > Seat finishes
- > Finitions de l'assise
- > Sitzfertigungen
- > Acabados asiento

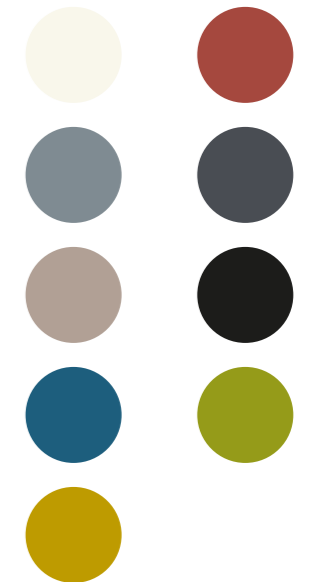



## 533

- > Sedia monoblocco in polipropilene, stampata a iniezione con tecnologia air moulding.
- > Monobloc chair in polypropylene made using the injected air-moulding technology.
- > Chaise, en polypropylène monobloc, moulée sous injection avec gaz air moulding.
- > Stuhl aus nur einem einzigen Teil aus Polypropylen, mit der Air-Moulding-Technologie injektionsgepresst.
- > Silla en polipropileno a inyección con tecnología air moulding.



## 533M

- > Sedia monoblocco in polipropilene con rivestimento in tessuto, stampata a iniezione con tecnologia air moulding.
- > Monobloc chair in polypropylene with upholstery made using the injected air-moulding technology.
- > Chaise, en polypropylène monobloc avec rembourrage, moulée sous injection avec gaz air moulding.
- > Stuhl aus nur einem einzigen Teil aus Polypropylen und Bezug aus Stoff, mit der Air-Moulding-Technologie injektionsgepresst.
- > Silla en polipropileno tapizada a inyección con tecnología air moulding.



## 533N

- > Sedia monoblocco in polipropilene, stampata a iniezione con tecnologia air moulding. Seduta imbottita rivestita in tessuto.
- > Monobloc chair in polypropylene made using the injected airmoulding technology. Upholstered seat.
- > Chaise, en polypropylène monobloc, moulée sous injection avec gaz air moulding. Assise rembourrée.
- > Stuhl aus nur einem einzigen Teil aus Polypropylen, mit der Air-Moulding-Technologie injektionsgepresst. Gepolsterte Sitzfläche.
- > Silla en polipropileno a inyección con tecnología air moulding. Asiento tapizado.



## 534

- > Sedia monoblocco con braccioli in polipropilene, stampata a iniezione con tecnologia air moulding.
- > Monobloc armchair in polypropylene made using the injected air-moulding technology.
- > Fauteuil en polypropylène monobloc, moulée sous injection avec gaz air moulding.
- > Armlehnstuhl aus nur einem einzigen Teil aus Polypropylen, mit der Air-Moulding-Technologie injektionsgepresst.
- > Silla monobloque en polipropileno con brazos moldeada por inyección con tecnología air moulding.



## 534N

- > Sedia monoblocco con braccioli in polipropilene, stampata a iniezione con tecnologia air moulding. Seduta imbottita rivestita in tessuto.
- > Monobloc armchair in polypropylene made using the injected air-moulding technology. Upholstered seat.
- > Fauteuil en polypropylène monobloc, moulée sous injection avec gaz air moulding. Assise rembourrée.
- > Armlehnstuhl aus nur einem einzigen Teil aus Polypropylen, mit der Air-Moulding-Technologie injektionsgepresst. Gepolsterte Sitzfläche.
- > Silla monobloque en polipropileno con brazos moldeada por inyección con tecnología air moulding. Asiento tapizado.



## 537

- > Sgabello monoblocco in polipropilene, stampato a iniezione con tecnologia air moulding.
- > Monobloc barstool in polypropylene made using the injected air-moulding technology.
- > Tabouret en polypropylène monobloc, moulée sous injection avec gaz air moulding.
- > Barhocker aus nur einem einzigen Teil aus Polypropylen, mit der Air-Moulding-Technologie injektionsgepresst.
- > Taburete monobloque en polipropileno moldeado por inyección con tecnología air moulding.



## 537B

- > Sgabello monoblocco in polipropilene, stampato a iniezione con tecnologia air moulding. Versione seduta H 66 cm.
- > Monobloc barstool in polypropylene made using the injected air-moulding technology. Version seat-height H 66 cm.
- > Tabouret en polypropylène monobloc, moulée sous injection avec gaz air moulding. Version hauteur assise 66 cm.
- > Barhocker aus nur einem einzigen Teil aus Polypropylen, mit der Air-Moulding-Technologie injektionsgepresst. Sitzhöhe 66 cm.
- > Taburete monobloque en polipropileno moldeado por inyección con tecnología air moulding. Altura asiento 66 cm.



## 536

- > Carrello per 10 Nassau 533 / 8 Nassau 534
- > Trolley for 10 Nassau 533 / 8 Nassau 534
- > Chariot pour 10 Nassau 533 / 8 Nassau 534
- > Transportwagen für 10 Nassau 533 / 8 Nassau 534
- > Carrito por 10 Nassau 533 / 8 Nassau 534

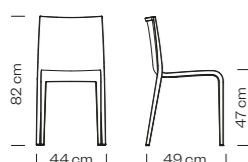

Peso / Weight / Poids / Gewicht / Peso **4,2 kg**

Imballo / Packaging Emballage / Verpackung / Embalaje **0,29 m³**

Pezzi per scatola / Pieces for box / Pièces par carton / Stücke in einem Karton / Piezas por caja **4**

Impilabile / Stackable / Empilable / Stapelbar / Apilable **8**



Peso / Weight / Poids / Gewicht / Peso **6,2 kg**

Imballo / Packaging Emballage / Verpackung / Embalaje **0,27 m³**

Pezzi per scatola / Pieces for box / Pièces par carton / Stücke in einem Karton / Piezas por caja **2**

Impilabile / Stackable / Empilable / Stapelbar / Apilable **4**



Peso / Weight / Poids / Gewicht / Peso **5,5 kg**

Imballo / Packaging Emballage / Verpackung / Embalaje **0,27 m³**

Pezzi per scatola / Pieces for box / Pièces par carton / Stücke in einem Karton / Piezas por caja **2**

Impilabile / Stackable / Empilable / Stapelbar / Apilable **4**



Peso / Weight / Poids / Gewicht / Peso **4,8 kg**

Imballo / Packaging Emballage / Verpackung / Embalaje **0,39 m³**

Pezzi per scatola / Pieces for box / Pièces par carton / Stücke in einem Karton / Piezas por caja **4**

Impilabile / Stackable / Empilable / Stapelbar / Apilable **8**

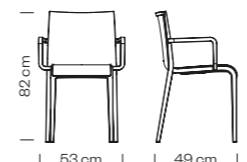

Peso / Weight / Poids / Gewicht / Peso **6 kg**

Imballo / Packaging Emballage / Verpackung / Embalaje **0,32 m³**

Pezzi per scatola / Pieces for box / Pièces par carton / Stücke in einem Karton / Piezas por caja **2**

Impilabile / Stackable / Empilable / Stapelbar / Apilable **4**

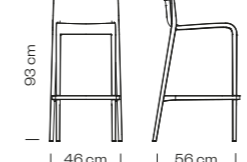

Peso / Weight / Poids / Gewicht / Peso **4,8 kg**

Imballo / Packaging Emballage / Verpackung / Embalaje **0,35 m³**

Pezzi per scatola / Pieces for box / Pièces par carton / Stücke in einem Karton / Piezas por caja **2**

Impilabile / Stackable / Empilable / Stapelbar / Apilable **5**



Peso / Weight / Poids / Gewicht / Peso **4,6 kg**

Imballo / Packaging Emballage / Verpackung / Embalaje **0,31 m³**

Pezzi per scatola / Pieces for box / Pièces par carton / Stücke in einem Karton / Piezas por caja **2**

Impilabile / Stackable / Empilable / Stapelbar / Apilable **5**

pif

design  
Marc Sadler

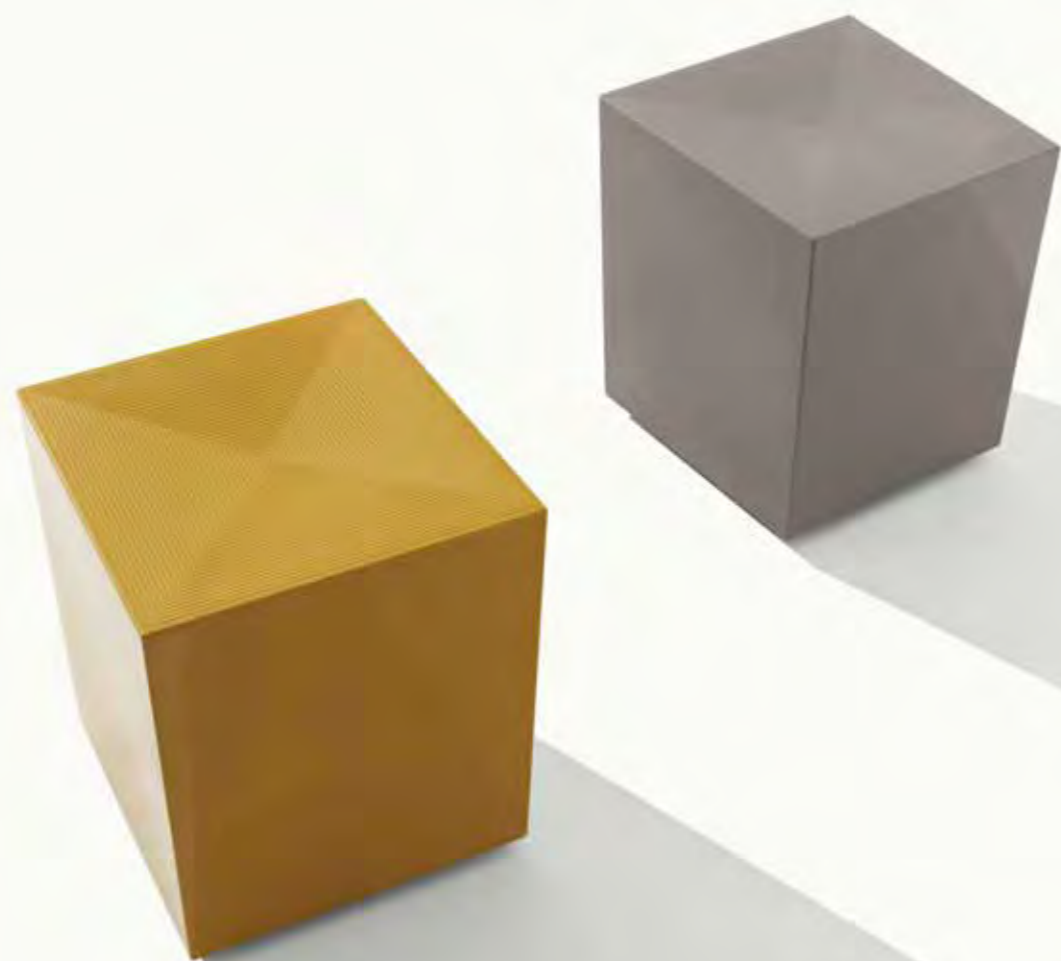

211

- > Pouf in polietilene stampato in rotazionale.
- > Pouf in polyethylene, rotational moulding.
- > Pouf en polyéthylène roto-moulé.
- > Hocker aus Rotationsverfahren gepresstem Polyäthylen.
- > Pouf en polietileno moldeado rotativo.

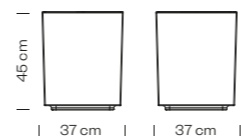

Peso / Weight / Poids / Gewicht / Peso **4 kg**

Imballo / Packaging / Emballage / Verpackung / Embalaje **0,08 m<sup>3</sup>**

Pezzi per scatola / Pieces per box / Pièces par carton / Stücke in einem Karton / Piezas por caja **1**

PE

- > Finiture seduta
- > Seat finishes
- > Finitions de l'assise
- > Sitzfertigungen
- > Acabados asiento

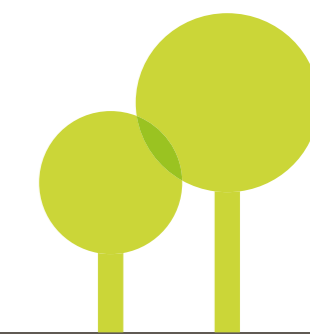



# dalton

design  
**Giulio lacchetti**

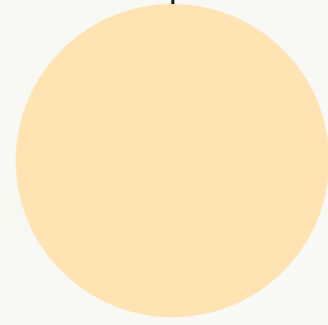











## TE

- > Finiture seduta (vedi p. 375)
- > Seat finishes (see p. 375)
- > Finitions de l'assise (voir p. 375)
- > Sitzfertigungen (sehen S. 375)
- > Acabados asiento (ver p. 375)

## LE

- > Finiture telaio
- > Frame finishes
- > Finitions piètement
- > Gestell Fertigungen
- > Acabados estructura

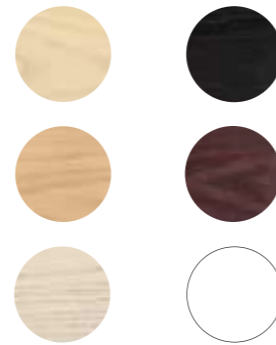

661

- > Sedia con seduta e schienale in frassino rivestiti in tessuto, telaio 4 gambe in frassino. Versione con schienale basso.
- > 4-leg chair with ash wood frame. Upholstered seat and back. Version with low backrest.
- > Chaise avec assise et dossier en bois revêtus en tissu, châssis 4 pieds en frêne; version avec dossier bas.
- > Stuhl mit gepolsterten Sitzfläche und Rückenlehne aus Esche, Gestell aus 4-beinigem Eschenholz. Ausführung mit niedrigem Rückenlehne.
- > Silla con estructura 4 patas en madera de fresno. Asiento y respaldo en madera de fresno tapizados. Versión con respaldo bajo.

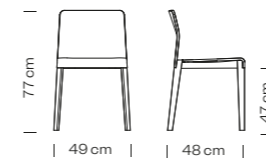

Peso / Weight / Poids / Gewicht / Peso **7,2 kg**

Imballo / Packaging / Emballage / Verpackung / Embalaje **0,24 m³**

Pezzi per scatola / Pieces per box / Pièces par carton / Stücke in einem Karton / Piezas por caja **1**



662

- > Sedia con seduta e schienale in frassino rivestiti in tessuto, telaio 4 gambe in frassino. Versione con schienale alto.
- > 4-leg chair with ash wood frame. Upholstered seat and back. Version with high backrest.
- > Chaise avec assise et dossier en bois revêtus en tissu, châssis 4 pieds en frêne; version avec dossier haut.
- > Stuhl mit gepolsterten Sitzfläche und Rückenlehne aus Esche, Gestell aus 4-beinigem Eschenholz. Ausführung mit hoher Rückenlehne.
- > Silla con estructura 4 patas en madera de fresno. Asiento y respaldo en madera de fresno tapizados. Versión con respaldo alto.

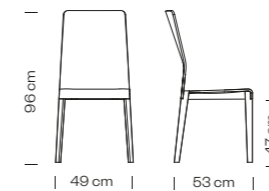

Peso / Weight / Poids / Gewicht / Peso **8,2 kg**

Imballo / Packaging / Emballage / Verpackung / Embalaje **0,28 m³**

Pezzi per scatola / Pieces per box / Pièces par carton / Stücke in einem Karton / Piezas por caja **1**



663

- > Sgabello con seduta e schienale in frassino rivestiti in tessuto, telaio 4 gambe in frassino.
- > 4-leg stool with ash wood frame. Upholstered seat and back.
- > Tabouret avec assise et dossier en bois revêtus en tissu, châssis 4 pieds en frêne.
- > Hocker mit gepolsterten Sitzfläche und Rückenlehne aus Esche, Gestell aus 4-beinigem Eschenholz.
- > Taburete con estructura 4 patas en madera de fresno. Asiento y respaldo en madera de fresno tapizados.

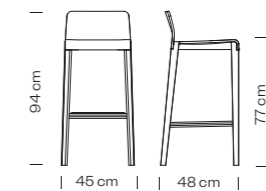

Peso / Weight / Poids / Gewicht / Peso **5,6 kg**

Imballo / Packaging / Emballage / Verpackung / Embalaje **0,28 m³**

Pezzi per scatola / Pieces per box / Pièces par carton / Stücke in einem Karton / Piezas por caja **1**



664

- > Poltrona lounge con seduta e schienale in frassino rivestiti in tessuto, telaio 4 gambe in frassino.
- > 4-leg lounge chair with ash wood frame. Upholstered seat and back.
- > Fauteuil lounge avec assise et dossier en bois revêtus en tissu, châssis 4 pieds en frêne.
- > Lounge-Sessel mit gepolsterten Sitzfläche und Rückenlehne aus Esche, Gestell aus 4-beinigem Eschenholz.
- > Sillón lounge estructura 4 patas en madera de fresno. Asiento y respaldo en madera de fresno tapizados.

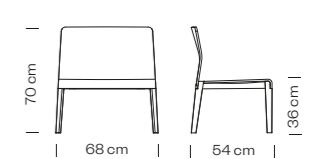

Peso / Weight / Poids / Gewicht / Peso **10,1 kg**

Imballo / Packaging / Emballage / Verpackung / Embalaje **0,39 m³**

Pezzi per scatola / Pieces per box / Pièces par carton / Stücke in einem Karton / Piezas por caja **1**

# ring

design  
**Radice Orlandini  
Design Studio**









670

- > Sedia con seduta e schienale in tessuto, telaio 4 gambe in tubo acciaio.
- > Chair with steel frame, 4 legs. Upholstered seat and back.
- > Chaise avec assise et dossier rembourrés, revêtement en tissu, châssis 4 pieds en acier.
- > Stuhl mit gepolsterten Sitzfläche und Rückenlehne, mit 4-beinigem Stahlgestell.
- > Silla con estructura tubular 4 patas en acero. Asiento y respaldo tapizados.

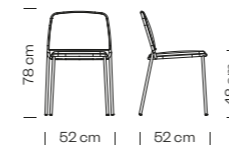

Peso / Weight / Poids / Gewicht / Peso **7,1 kg**

Imballo / Packaging / Emballage / Verpackung / Embalaje **0,39 m<sup>3</sup>**

Pezzi per scatola / Pieces per box / Pièces par carton / Stücke in einem Karton / Piezas por caja **4**

Impilabile / Stackable / Empilable / Stapelbar / Apilable **4**



671

- > Poltroncina con seduta e schienale in tessuto, telaio 4 gambe in tubo acciaio.
- > Armchair with steel frame, 4 legs. Upholstered seat and back.
- > Fauteuil avec assise et dossier rembourrés, revêtement en tissu, châssis 4 pieds en acier.
- > Armlehnstuhl mit gepolsterten Sitzfläche und Rückenlehne, mit 4-beinigem Stahlgestell.
- > Sillón con estructura tubular 4 patas en acero. Asiento y respaldo tapizados.



Peso / Weight / Poids / Gewicht / Peso **7,5 kg**

Imballo / Packaging / Emballage / Verpackung / Embalaje **0,39 m<sup>3</sup>**

Pezzi per scatola / Pieces per box / Pièces par carton / Stücke in einem Karton / Piezas por caja **4**

Impilabile / Stackable / Empilable / Stapelbar / Apilable **4**



672

- > Sgabello con seduta e schienale in tessuto, telaio 4 gambe in tubo acciaio.
- > Barstool with steel frame, 4 legs. Upholstered seat and back.
- > Tabouret avec assise et dossier rembourrés, revêtement en tissu, châssis 4 pieds en acier.
- > Barhocker mit gepolsterten Sitzfläche und Rückenlehne, mit 4-beinigem Stahlgestell.
- > Taburete con estructura tubular 4 patas en acero. Asiento y respaldo tapizados.



Peso / Weight / Poids / Gewicht / Peso **7,4 kg**

Imballo / Packaging / Emballage / Verpackung / Embalaje **0,40 m<sup>3</sup>**

Pezzi per scatola / Pieces per box / Pièces par carton / Stücke in einem Karton / Piezas por caja **2**

Impilabile / Stackable / Empilable / Stapelbar / Apilable **4**

TE

- > Finiture seduta (vedi p. 375)
- > Seat finishes (see p. 375)
- > Finitions de l'assise (voir p. 375)
- > Sitzfertigungen (sehen S. 375)
- > Acabados asiento (ver p. 375)

AC

- > Finiture telaio (vedi p. 397)
- > Frame finishes (see p. 397)
- > Finitions piètement (voir p. 397)
- > Gestell Fertigungen (sehen S. 397)
- > Acabados estructura (ver p. 397)

# nomad

design  
rdm

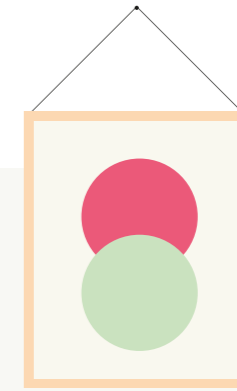





## TE

- > Finiture seduta (vedi p. 375)
- > Seat finishes (see p. 375)
- > Finitions de l'assise (voir p. 375)
- > Sitzfertigungen (sehen S. 375)
- > Acabados asiento (ver p. 375)

## AC

- > Finiture telaio (vedi p. 397)
- > Frame finishes (see p. 397)
- > Finitions piètement (voir p. 397)
- > Gestell Fertigungen (sehen S. 397)
- > Acabados estructura (ver p. 397)

## LE

- > Finiture telaio
- > Frame finishes
- > Finitions piètement
- > Gestell Fertigungen
- > Acabados estructura

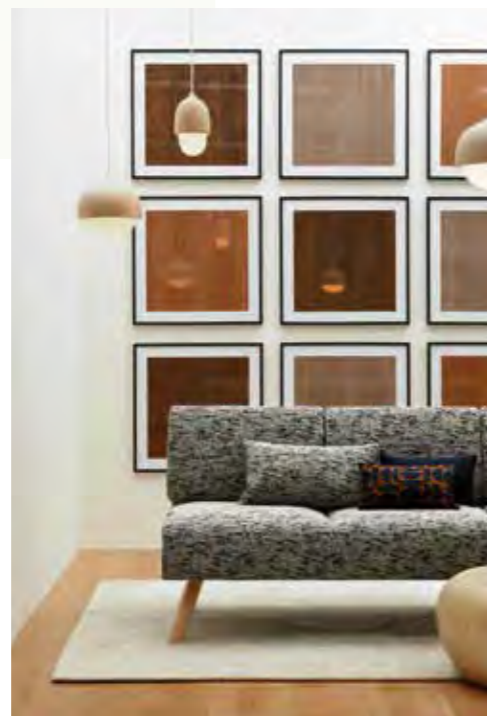

## 821

- > Divano 2 posti con seduta e schienale imbottiti, rivestimento in tessuto, piedi in tubo acciaio. Versione senza fianchi.
- > 2 seats sofa with upholstered seat and back. Steel feet, without armrests.
- > Canapé 2 places avec assise et dossier rembourrés, revêtement en tissu, pieds en acier. Version sans accoudoirs.
- > 2-Sitzer-Sofa mit gepolsterten Sitzfläche und Rückenlehne. Bezug aus Stoff. Gestell aus Stahlrohren. Ausführung ohne Armstützen.
- > Sofa 2 asientos con asiento y respaldo tapizados. Pies en acero. Versión sin apoyabrazos.



## 822

- > Divano 2 posti con seduta e schienale imbottiti, rivestimento in tessuto, piedi in tubo acciaio. Versione con fianchi.
- > 2 seats sofa with upholstered seat and back. Steel feet, with armrests.
- > Canapé 2 places avec assise et dossier rembourrés, revêtement en tissu, pieds en acier. Version avec accoudoirs.
- > 2-Sitzer-Sofa mit gepolsterten Sitzfläche und Rückenlehne. Bezug aus Stoff. Gestell aus Stahlrohren. Ausführung mit Armstützen.
- > Sofa 2 asientos con asiento y respaldo tapizados. Pies en acero. Versión con apoyabrazos.



## 825

- > Divano 2 posti con seduta e schienale imbottiti, rivestimento in tessuto, piedi in faggio. Versione senza fianchi.
- > 2 seats sofa with upholstered seat and back. Beech wood feet, without armrests.
- > Canapé 2 places avec assise et dossier rembourrés, revêtement en tissu, pieds en hêtre. Version sans accoudoirs.
- > 2-Sitzer-Sofa mit gepolsterten Sitzfläche und Rückenlehne. Bezug aus Stoff. Gestell aus Buchenholzrohren. Ausführung ohne Armstützen.
- > Sofa 2 asientos con asiento y respaldo tapizados. Pies en madera de haya. Versión sin apoyabrazos.



## 826

- > Divano 2 posti con seduta e schienale imbottiti, rivestimento in tessuto, piedi in faggio. Versione con fianchi.
- > 2 seats sofa with upholstered seat and back. Beech wood feet, with armrests.
- > Canapé 2 places avec assise et dossier rembourrés, revêtement en tissu, pieds en hêtre. Version avec accoudoirs.
- > 2-Sitzer-Sofa mit gepolsterten Sitzfläche und Rückenlehne. Bezug aus Stoff. Gestell aus Buchenholzrohren. Ausführung mit Armstützen.
- > Sofa 2 asientos con asiento y respaldo tapizados. Pies en madera de haya. Versión con apoyabrazos.

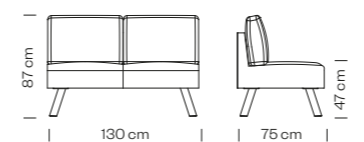

Peso / Weight / Poids / Gewicht / Peso **27,2 kg**

Imballo / Packaging / Emballage / Verpackung / Embalaje **0,61 m³**

Pezzi per scatola / Pieces per box / Pièces par carton / Stücke in einem Karton / Piezas por caja **1**

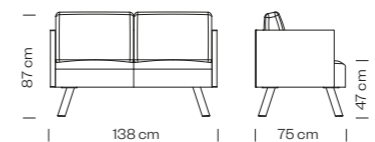

Peso / Weight / Poids / Gewicht / Peso **32,5 kg**

Imballo / Packaging / Emballage / Verpackung / Embalaje **0,61 m³**

Pezzi per scatola / Pieces per box / Pièces par carton / Stücke in einem Karton / Piezas por caja **1**

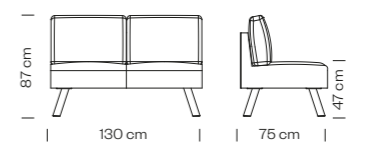

Peso / Weight / Poids / Gewicht / Peso **28 kg**

Imballo / Packaging / Emballage / Verpackung / Embalaje **0,61 m³**

Pezzi per scatola / Pieces per box / Pièces par carton / Stücke in einem Karton / Piezas por caja **1**

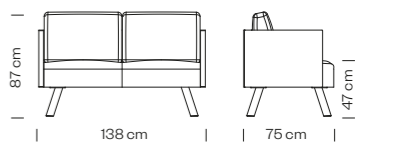

Peso / Weight / Poids / Gewicht / Peso **33,3 kg**

Imballo / Packaging / Emballage / Verpackung / Embalaje **0,61 m³**

Pezzi per scatola / Pieces per box / Pièces par carton / Stücke in einem Karton / Piezas por caja **1**





# 823

- > Divano 3 posti con seduta e schienale imbottiti, rivestimento in tessuto, piedi in tubo acciaio. Versione senza fianchi.
- > 3 seats sofa with upholstered seat and back. Steel feet, without armrests.
- > Canapé 3 places avec assise et dossier rembourrés, revêtement en tissu, pieds en acier. Version sans accoudoirs.
- > 3-Sitzer-Sofa mit gepolsterten Sitzfläche und Rückenlehne. Bezug aus Stoff. Gestell aus Stahlrohren. Ausführung ohne Armstützen.
- > Sofa 3 asientos con asiento y respaldo tapizados. Pies en acero. Versión sin apoyabrazos.

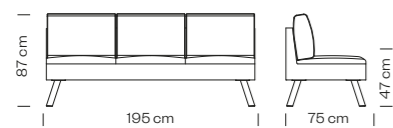

Peso / Weight / Poids / Gewicht / Peso **39,1 kg**

Imballo / Packaging / Emballage / Verpackung / Embalaje **0,88 m<sup>3</sup>**

Pezzi per scatola / Pieces per box / Pièces par carton / Stücke in einem Karton / Piezas por caja **1**



# 827

- > Divano 3 posti con seduta e schienale imbottiti, rivestimento in tessuto, piedi in faggio. Versione senza fianchi.
- > 3 seats sofa with upholstered seat and back. Beech wood feet, without armrests.
- > Canapé 3 places avec assise et dossier rembourrés, revêtement en tissu, pieds en hêtre. Version sans accoudoirs.
- > 3-Sitzer-Sofa mit gepolsterten Sitzfläche und Rückenlehne. Bezug aus Stoff. Gestell aus Buchenholzrohren. Ausführung ohne Armstützen.
- > Sofa 3 asientos con asiento y respaldo tapizados. Pies en madera de haya. Versión sin apoyabrazos.

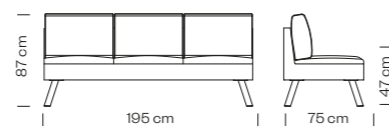

Peso / Weight / Poids / Gewicht / Peso **39,9 kg**

Imballo / Packaging / Emballage / Verpackung / Embalaje **0,88 m<sup>3</sup>**

Pezzi per scatola / Pieces per box / Pièces par carton / Stücke in einem Karton / Piezas por caja **1**



# 824

- > Divano 3 posti con seduta e schienale imbottiti, rivestimento in tessuto, piedi in tubo acciaio. Versione con fianchi.
- > 3 seats sofa with upholstered seat and back. Steel feet, with armrests.
- > Canapé 3 places avec assise et dossier rembourrés, revêtement en tissu, pieds en acier. Version avec accoudoirs.
- > 3-Sitzer-Sofa mit gepolsterten Sitzfläche und Rückenlehne. Bezug aus Stoff. Gestell aus Stahlrohren. Ausführung mit Armstützen.
- > Sofa 3 asientos con asiento y respaldo tapizados. Pies en acero. Versión con lados.

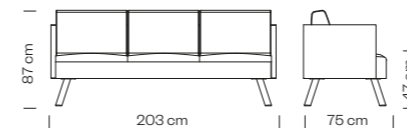

Peso / Weight / Poids / Gewicht / Peso **45,6 kg**

Imballo / Packaging / Emballage / Verpackung / Embalaje **0,88 m<sup>3</sup>**

Pezzi per scatola / Pieces per box / Pièces par carton / Stücke in einem Karton / Piezas por caja **1**



# 828

- > Divano 3 posti con seduta e schienale imbottiti, rivestimento in tessuto, piedi in faggio. Versione con fianchi.
- > 3 seats sofa with upholstered seat and back. Beech wood feet, with armrests.
- > Canapé 3 places avec assise et dossier rembourrés, revêtement en tissu, pieds en hêtre. Version avec accoudoirs.
- > 3-Sitzer-Sofa mit gepolsterten Sitzfläche und Rückenlehne. Bezug aus Stoff. Gestell aus Buchenholzrohren. Ausführung mit Armstützen.
- > Sofa 3 asientos con asiento y respaldo tapizados. Pies en madera de haya. Versión con apoyabrazos.

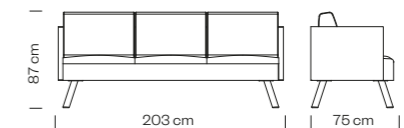

Peso / Weight / Poids / Gewicht / Peso **46,4 kg**

Imballo / Packaging / Emballage / Verpackung / Embalaje **0,88 m<sup>3</sup>**

Pezzi per scatola / Pieces per box / Pièces par carton / Stücke in einem Karton / Piezas por caja **1**

# flint

design  
Marc Sadler



## 535-A

- > Poltroncina con telaio a 4 gambe in tubo acciaio, seduta in poliammide, legno di Iroko e schienale in tondino acciaio.
- > Armchair with 4 legs steel frame and backrest, polyamide or Iroko wood seat. Backrest in steel wire.
- > Fauteuil avec châssis 4 pieds en acier, assise en polyamide, bois Iroko, dossier en fil d'acier.
- > Armlehnstuhl mit 4-beinigem Stahlgestell. Sitzfläche aus Polyamid, Iroko und Rückenlehne aus Stahlstangen.
- > Sillón con estructura tubular 4 patas en acero, asiento en poliamida, madera de iroko y respaldo en acero.

## 535-B

- > Sedia con telaio a 4 gambe in tubo acciaio, seduta in poliammide o legno di Iroko e schienale in tondino acciaio.
- > Chair with 4 legs steel frame and backrest, polyamide or Iroko wood seat. Backrest in steel wire.
- > Chaise avec châssis 4 pieds en acier, assise en polyamide ou bois Iroko, dossier en fil d'acier.
- > Stuhl mit 4-beinigem Stahlgestell. Sitzfläche aus Polyamid oder Iroko und Rückenlehne aus Stahlstangen.
- > Silla con estructura tubular 4 patas en acero, asiento en poliamida o madera de iroko y respaldo en acero.

## AC

- > Finiture telaio (vedi p. 401)
- > Frame finishes (see p. 401)
- > Finitions piètement (voir p. 401)
- > Gestell Fertigungen (sehen S. 401)
- > Acabados estructura (ver p. 401)

## PA

- > Finiture seduta
- > Seat finishes
- > Finitions de l'assise
- > Sitzfertigungen
- > Acabados asiento

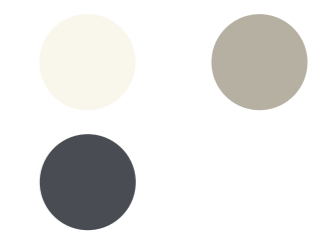

## LE

- > Finiture seduta
- > Seat finishes
- > Finitions de l'assise
- > Sitzfertigungen
- > Acabados asiento

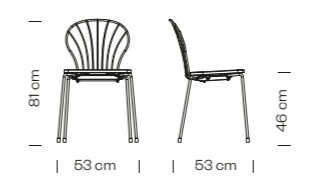
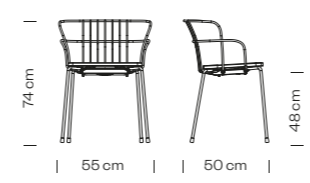
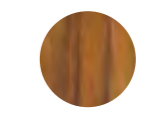

Peso / Weight / Poids / Gewicht / Peso **6,5 kg**

Imballo / Packaging / Emballage / Verpackung / Embalaje **0,39 m³**

Pezzi per scatola / Pieces per box / Pièces par carton / Stücke in einem Karton / Piezas por caja **4**

Impilabile / Stackable / Empilable / Stapelbar / Apilable **4**

Peso / Weight / Poids / Gewicht / Peso **5,3 kg**

Imballo / Packaging / Emballage / Verpackung / Embalaje **0,39 m³**

Pezzi per scatola / Pieces per box / Pièces par carton / Stücke in einem Karton / Piezas por caja **4**

Impilabile / Stackable / Empilable / Stapelbar / Apilable **4**



# stripes

design  
**Talocci Design**

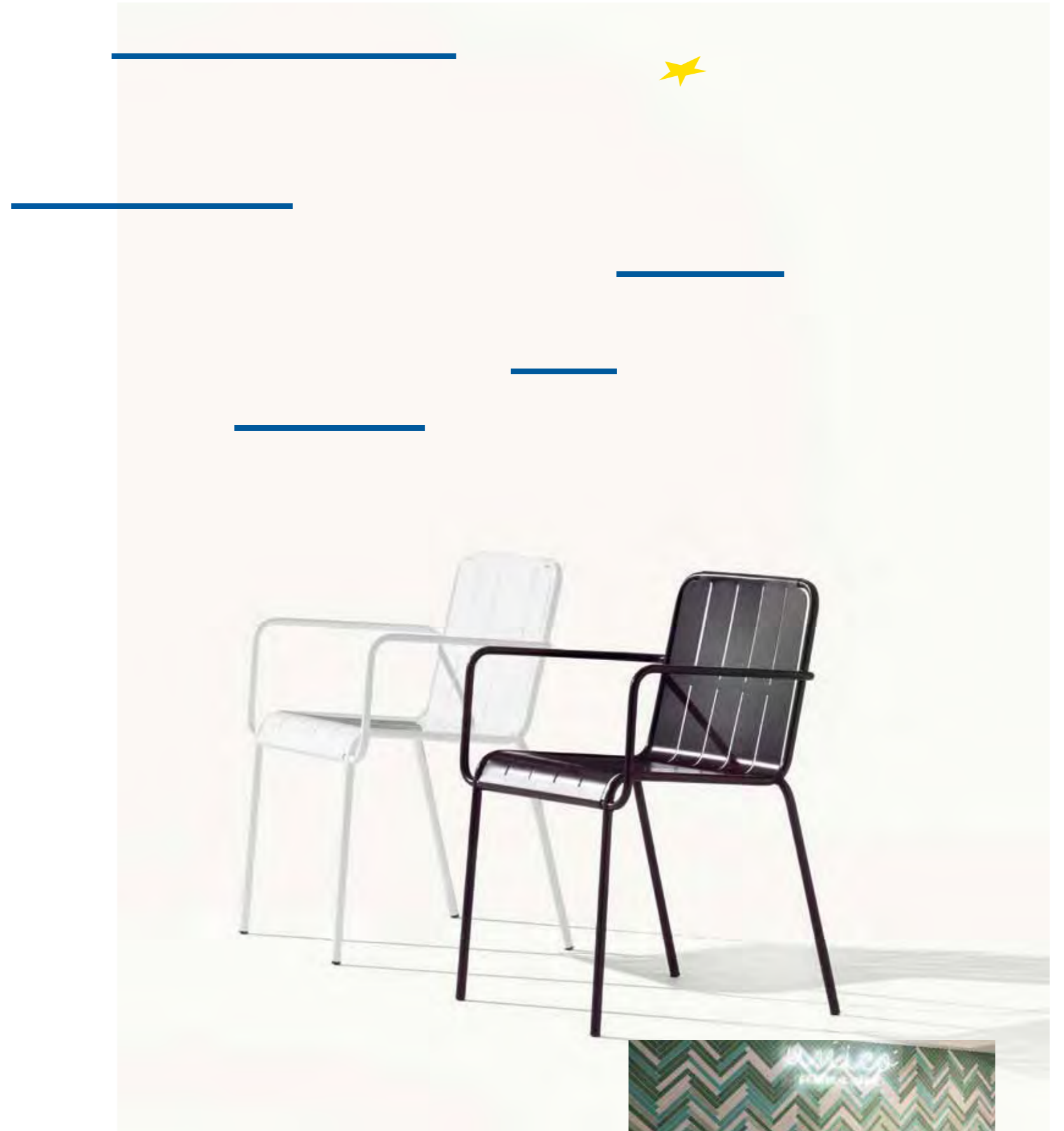



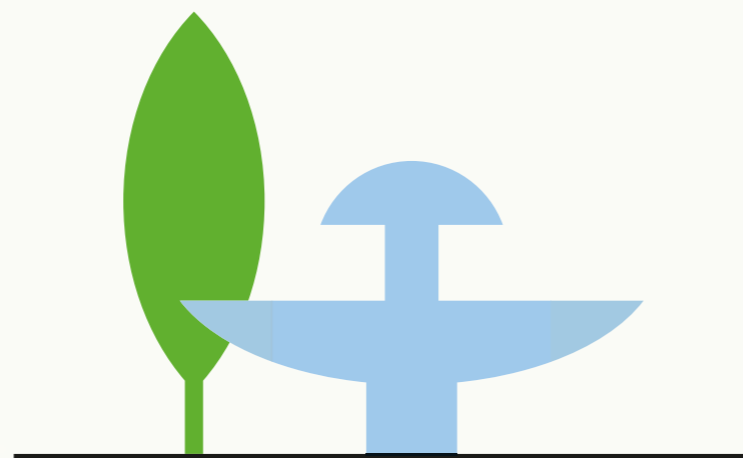

547

- > Sedia con telaio a 4 gambe in acciaio, seduta e schienale in lamiera. Trattamento in cataforesi.
- > Chair with steel frame, 4 legs. Seat and back in moulded steel. Cataphoresis treatment.
- > Chaise avec châssis 4 pieds en acier avec traitement en cataphorèse, assise et dossier en tôle.
- > Stuhl mit 4-beinigem Stahlgestell, Sitzfläche und Rückenlehne in gepressten Stahl. Mit Kataphorese.
- > Silla con estructura 4 patas en acero, asiento y respaldo en plancha de acero. Con tratamiento de cataforesis.

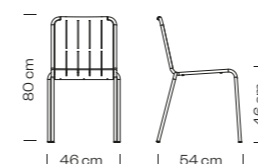

Peso / Weight / Poids / Gewicht / Peso **6 kg**

Imballo / Packaging / Emballage / Verpackung / Embalaje **0,37 m³**

Pezzi per scatola / Pieces per box / Pièces par carton / Stücke in einem Karton / Piezas por caja **4**

Impilabile / Stackable / Empilable / Stapelbar / Apilable **4**



548

- > Sedia con braccioli e telaio a 4 gambe in acciaio, seduta e schienale in lamiera. Trattamento in cataforesi.
- > Chair with armrests in steel frame, 4 legs. Seat and back in moulded steel. Cataphoresis treatment.
- > Chaise avec châssis 4 pieds en acier avec traitement en cataphorèse, assise et dossier en tôle. Avec accoudoirs.
- > Armlehnstuhl mit 4-beinigem Stahlgestell, Sitzfläche und Rückenlehne in gepressten Stahl. Mit Kataphorese.
- > Silla con estructura 4 patas en acero con brazos, asiento y respaldo en plancha de acero. Con tratamiento de cataforesis.

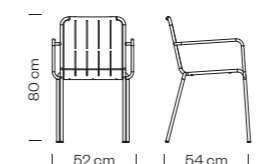

Peso / Weight / Poids / Gewicht / Peso **6,8 kg**

Imballo / Packaging / Emballage / Verpackung / Embalaje **0,37 m³**

Pezzi per scatola / Pieces per box / Pièces par carton / Stücke in einem Karton / Piezas por caja **4**

Impilabile / Stackable / Empilable / Stapelbar / Apilable **4**

AC

- > Finiture seduta (vedi p. 397)
- > Seat finishes (see p. 397)
- > Finitions de l'assise (voir p. 397)
- > Sitzfertigungen (sehen S. 397)
- > Acabados asiento (ver p. 397)



**play**

design  
**Radice Orlandini  
Design Studio**

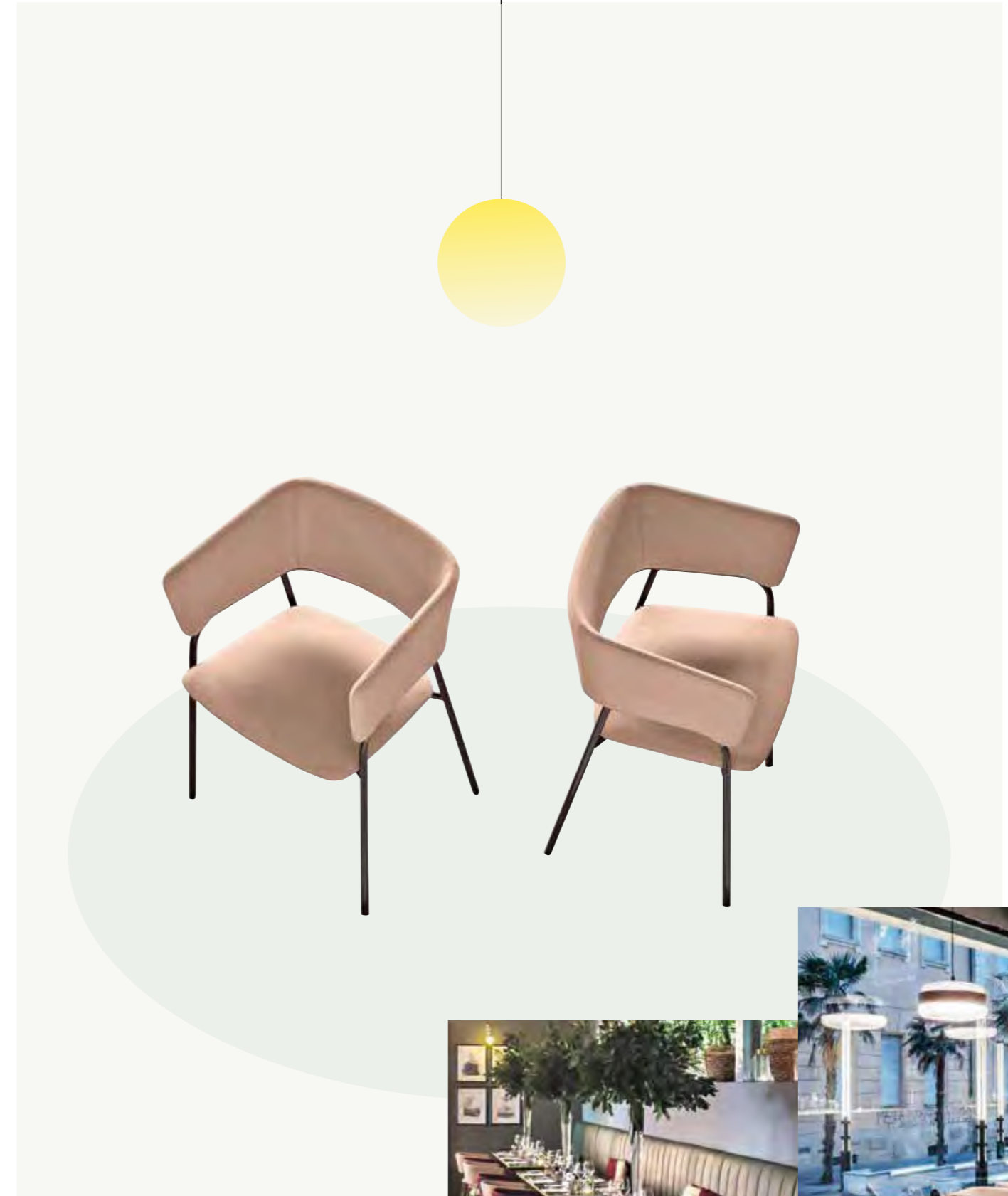

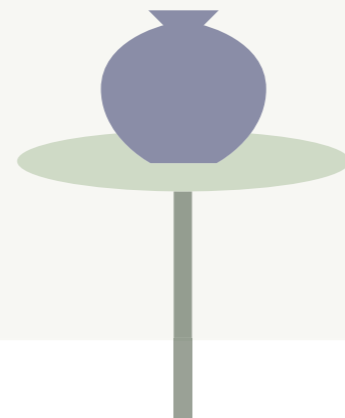
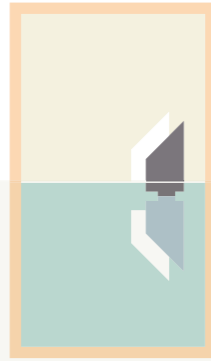

538

- > Poltroncina con telaio a 4 gambe in tubo acciaio, seduta e schienale imbottiti, rivestimento in tessuto.
- > Armchair with steel frame, 4 legs. Upholstered seat and back.
- > Fauteuil avec assise et dossier rembourrés, revêtement en tissu, châssis 4 pieds en acier.
- > Armlehnstuhl mit 4-beinigem Stahlgestell. Gepolsterte Sitzfläche und Rückenlehne. Bezug aus Stoff.
- > Sillón con estructura tubular 4 patas en acero. Asiento y respaldo tapizados.

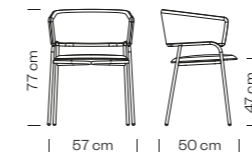

Peso / Weight / Poids / Gewicht / Peso **7,7 kg**

Imballo / Packaging / Emballage / Verpackung / Embalaje **0,26 m³**

Pezzi per scatola / Pieces per box / Pièces par carton / Stücke in einem Karton / Piezas por caja **1**



TE

- > Finiture seduta (vedi p. 375)
- > Seat finishes (see p. 375)
- > Finitions de l'assise (voir p. 375)
- > Sitzfertigungen (sehen S. 375)
- > Acabados asiento (ver p. 375)

AC

- > Finiture telaio (vedi p. 397)
- > Frame finishes (see p. 397)
- > Finitions piètement (voir p. 397)
- > Gestell Fertigungen (sehen S. 397)
- > Acabados estructura (ver p. 397)





to-kyo

design  
Makio Hasuike & Co.

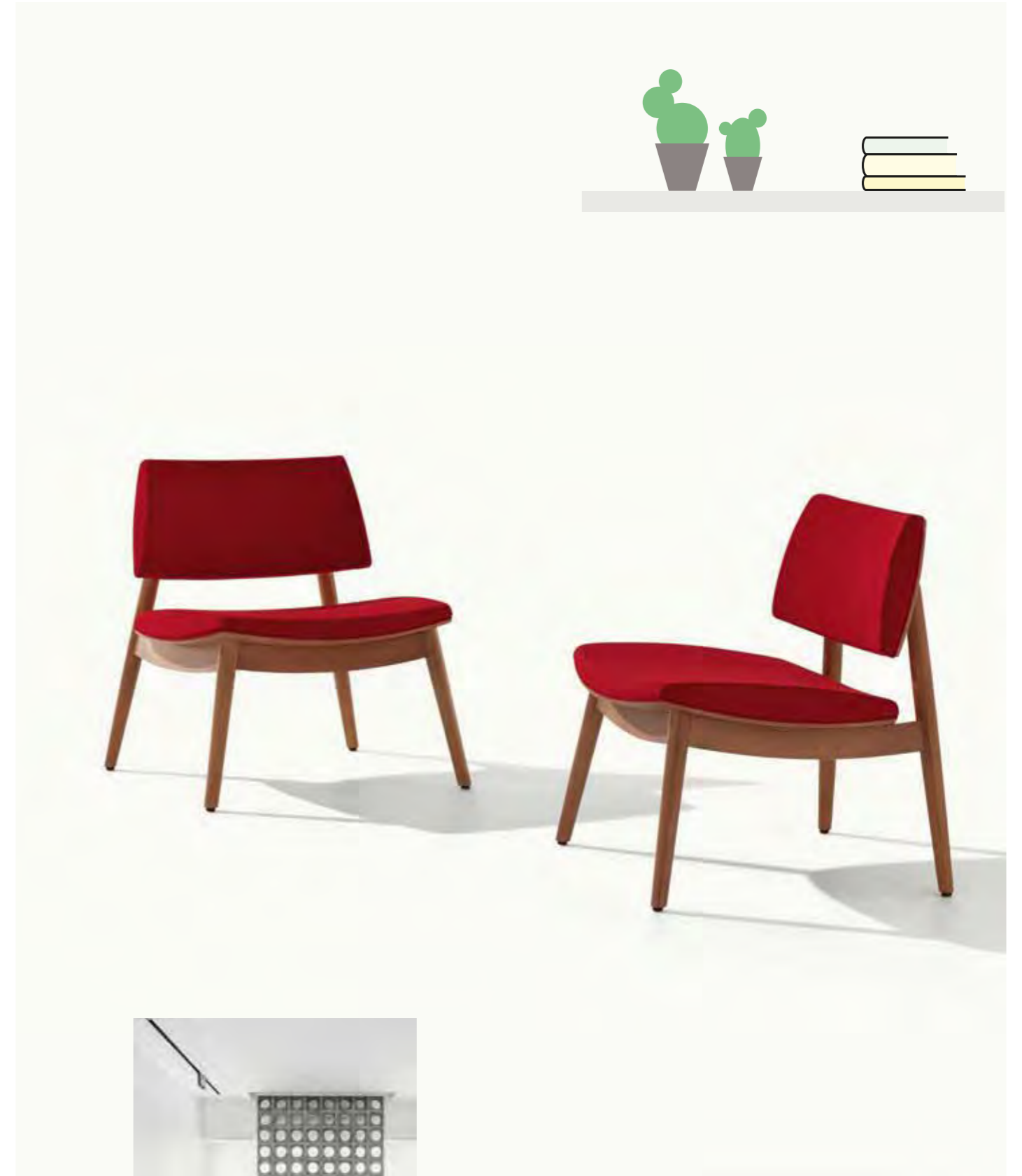
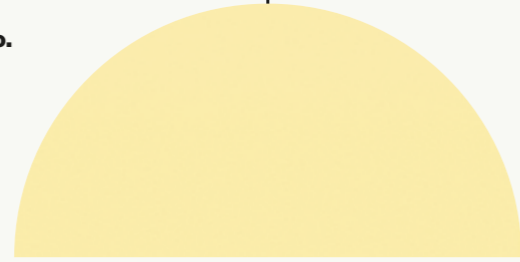





## 540

- > Sedia con telaio a 4 gambe in faggio. Sedile e schienale in tessuto.
- > Chair with beech wood frame, 4 legs. Upholstered seat and back.
- > Chaise avec châssis 4 pieds en hêtre. Assise et dossier en tissu.
- > Stuhl mit 4-beinigem Buchenholzgestell. Gepolsterte Sitzfläche und Rückenlehne.
- > Silla con estructura 4 patas en madera de haya. Asiento y respaldo tapizados.



Peso / Weight / Poids / Gewicht / Peso **6 kg**

Imballo / Packaging / Emballage / Verpackung / Embalaje **0,29 m³**

Pezzi per scatola / Pieces per box / Pièces par carton / Stücke in einem Karton / Piezas por caja **1**

## 541

- > Poltrona lounge con telaio a 4 gambe in faggio. Sedile e schienale in tessuto.
- > Lounge chair with beech wood frame, 4 legs. Upholstered seat and back.
- > Chaise lounge avec châssis 4 pieds en hêtre. Assise et dossier en tissu.
- > Lounge-Sofa mit 4-beinigem Buchenholzgestell. Gepolsterte Sitzfläche und Rückenlehne.
- > Sillón lounge con estructura 4 patas en madera de haya. Asiento y respaldo tapizados.

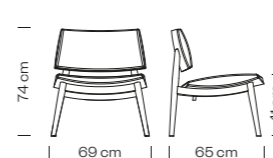

Peso / Weight / Poids / Gewicht / Peso **9 kg**

Imballo / Packaging / Emballage / Verpackung / Embalaje **0,50 m³**

Pezzi per scatola / Pieces per box / Pièces par carton / Stücke in einem Karton / Piezas por caja **1**

## TE

- > Finiture seduta (vedi p. 375)
- > Seat finishes (see p. 375)
- > Finitions de l'assise (voir p. 375)
- > Sitzfertigungen (sehen S. 375)
- > Acabados asiento (ver p. 375)

## LE

- > Finiture telaio
- > Frame finishes
- > Finitions piètement
- > Gestell Fertigungen
- > Acabados estructura

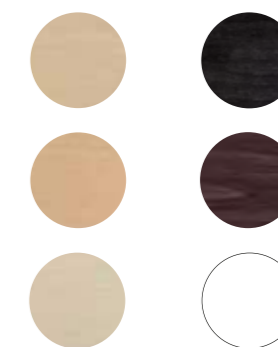



# maré

design  
Marc Sadler

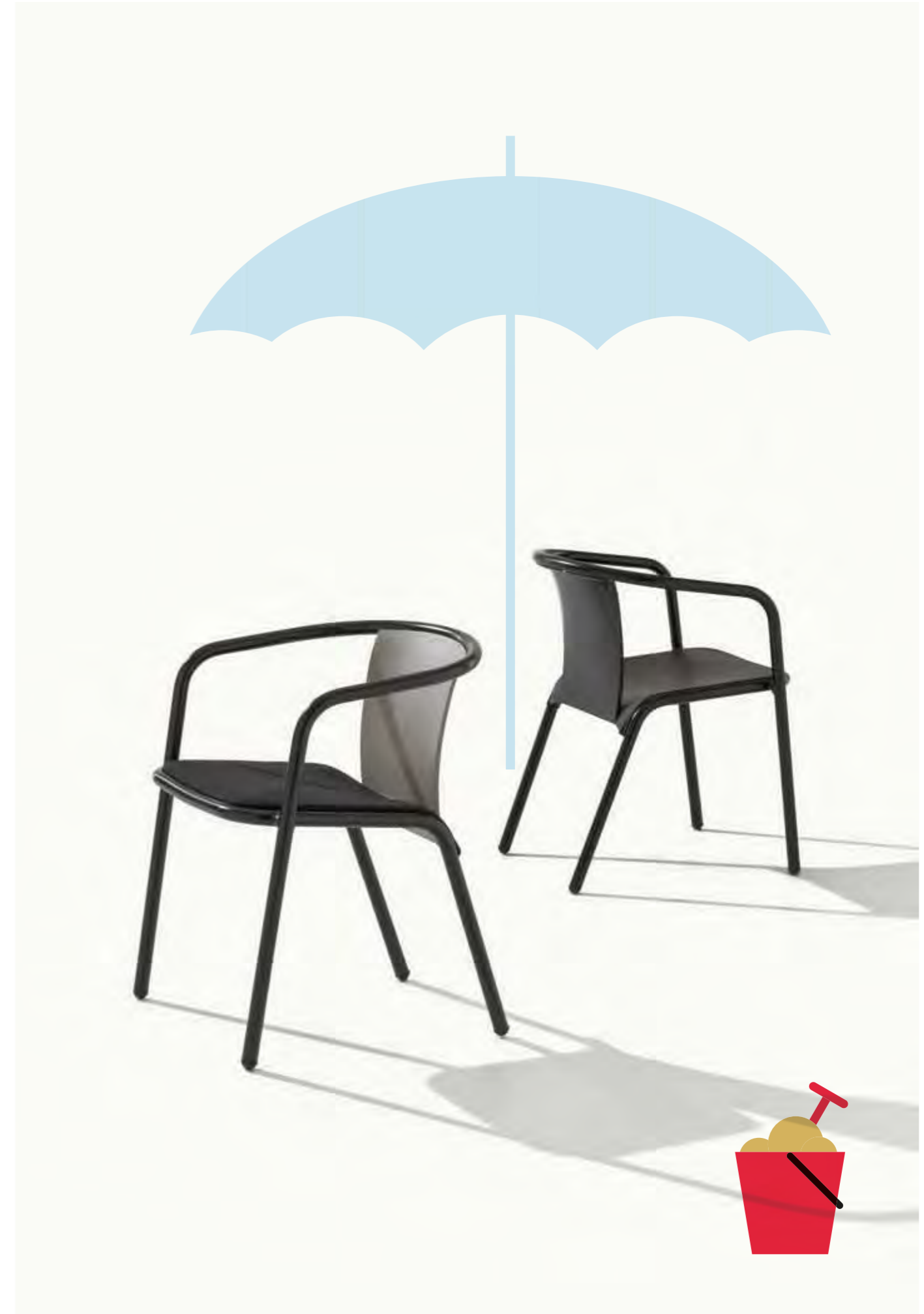

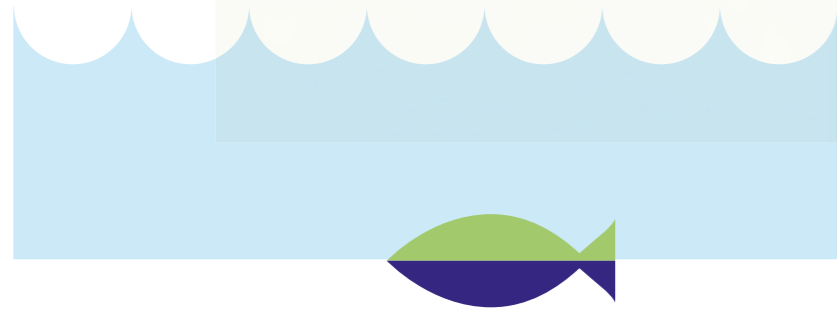





539

- > Poltroncina con telaio a 4 gambe in tubo alluminio anodizzato o verniciato.  
Seduta in polipropilene.
- > Armchair with anodized or powder coated aluminium frame, 4 legs. Polypropylene seat and back.
- > Fauteuil avec chassis 4 pieds en aluminium anodisé ou verni. Coque en polypropylène.
- > Armlehnstuhl mit 4-beinigem Aluminiumgestell in eloxierter oder lackierter Ausführung. Sitzfläche aus Polypropylen.
- > Sillón con estructura 4 patas en aluminio anodizado o barnizado. Carcasa en polipropileno.

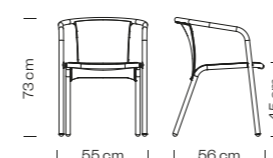

Peso / Weight / Poids / Gewicht / Peso **4,5 kg**

Imballo / Packaging / Emballage / Verpackung / Embalaje **0,47 m³**

Pezzi per scatola / Pieces per box / Pièces par carton / Stücke in einem Karton / Piezas por caja **4**

Impilabile / Stackable / Empilable / Stapelbar / Apilable **4**



TE

- > Finiture seduta (vedi p. 375)
- > Seat finishes (see p. 375)
- > Finitions de l'assise (voir p. 375)
- > Sitzfertigungen (sehen S. 375)
- > Acabados asiento (ver p. 375)

PP

- > Finiture seduta
- > Seat finishes
- > Finitions de l'assise
- > Sitzfertigungen
- > Acabados asiento



AL VR

- > Finiture telaio (vedi p. 400)
- > Frame finishes (see p. 400)
- > Finitions piètement (voir p. 400)
- > Gestell Fertigungenn (sehen S. 400)
- > Acabados estructura (ver p. 400)

AL AND

- > Finiture telaio
- > Frame finishes
- > Finitions piètement
- > Gestell Fertigungen
- > Acabados estructura





# kontea

design  
**Carlo Bimbi Design**

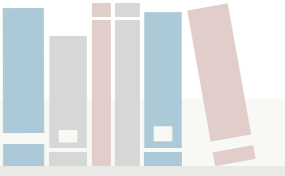



586

- > Poltroncina con telaio a 4 gambe in tubo acciaio. Sedile e schienale in tessuto.
- > Armchair with 4 legs steel frame and upholstered seat and back.
- > Fauteuil avec châssis 4 pieds en acier. Assise et dossier en tissu.
- > Armlehnstuhl mit 4-beinigem Stahlgestell. Gepolsterte Sitzfläche und Rückenlehne.
- > Sillón con estructura tubular 4 patas en acero. Asiento y respaldo tapizados.



587

- > Poltroncina con telaio a basamento centrale girevole in acciaio. Sedile e schienale in tessuto.
- > Swivel armchair with central steel base and upholstered seat and back.
- > Fauteuil pivotant avec piétement central en acier. Assise et dossier en tissu.
- > Armlehnstuhl mit Gestell auf zentralem, drehbarem Standfuss aus Stahl. Gepolsterte Sitzfläche und Rückenlehne.
- > Sillón con estructura columna central en acero, giratoria. Asiento y respaldo tapizados.



588

- > Poltroncina con telaio a 4 razze in tubo acciaio. Sedile e schienale in tessuto.
- > Armchair with 4 ways steel frame. Upholstered seat and back.
- > Fauteuil avec châssis 4 branches en hêtre. Assise et dossier en tissu.
- > Armlehnstuhl mit 4-armigem Fusskreuz aus Stahl. Gepolsterte Sitzfläche und Rückenlehne.
- > Sillón con estructura tubular 4 radios en acero. Asiento y respaldo tapizados.



590

- > Poltroncina con telaio a 4 gambe in faggio. Sedile e schienale in tessuto.
- > Armchair with beech wood frame, 4 legs. Upholstered seat and back.
- > Fauteuil avec châssis 4 pieds en hêtre. Assise et dossier en tissu.
- > Armlehnstuhl mit 4-beinigem Buchenholzgestell. Gepolsterte Sitzfläche und Rückenlehne.
- > Sillón con estructura 4 patas en madera de haya. Asiento y respaldo tapizados.



307

- > Sgabello con telaio a 4 gambe in tubo acciaio. Sedile e schienale in tessuto.
- > Barstool with 4 legs steel frame. Upholstered seat and back.
- > Tabouret avec châssis en acier 4 pieds. Assise et dossier en tissu.
- > Barhocker mit 4-beinigem Stahlgestell. Gepolsterte Sitzfläche und Rückenlehne.
- > Taburete con estructura tubular 4 patas en acero. Asiento y respaldo tapizados.



310

- > Sgabello con telaio a basamento centrale girevole in acciaio. Sedile e schienale in tessuto.
- > Swivel barstool with central steel frame. Upholstered seat and back.
- > Tabouret pivotant avec piétement central en acier. Assise et dossier en tissu.
- > Barhocker mit Gestell auf zentralem, drehbarem Standfuss aus Stahl. Gepolsterte Sitzfläche und Rückenlehne.
- > Taburete con estructura columna central en acero, giratoria. Asiento y respaldo tapizados.

TE

- > Finiture seduta (vedi p. 375)
- > Seat finishes (see p. 375)
- > Finitions de l'assise (voir p. 375)
- > Sitzfertigungen (sehen S. 375)
- > Acabados asiento (ver p. 375)

LE

- > Finiture telaio
- > Frame finishes
- > Finitions piètement
- > Gestell Fertigungen
- > Acabados estructura



AC

- > Finiture telaio (vedi p. 397)
- > Frame finishes (see p. 397)
- > Finitions piètement (voir p. 397)
- > Gestell Fertigungen (sehen S. 397)
- > Acabados estructura (ver p. 397)

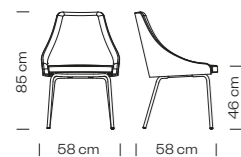

Peso / Weight / Poids / Gewicht / Peso **9 kg**

Imballo / Packaging / Emballage / Verpackung / Embalaje **0,34 m³**

Pezzi per scatola / Pieces per box / Pièces par carton / Stücke in einem Karton / Piezas por caja **1**

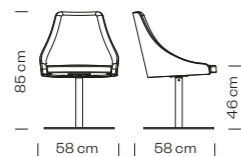

Peso / Weight / Poids / Gewicht / Peso **20 kg**

Imballo / Packaging / Emballage / Verpackung / Embalaje **0,34 m³**

Pezzi per scatola / Pieces per box / Pièces par carton / Stücke in einem Karton / Piezas por caja **1**

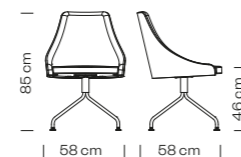

Peso / Weight / Poids / Gewicht / Peso **9 kg**

Imballo / Packaging / Emballage / Verpackung / Embalaje **0,34 m³**

Pezzi per scatola / Pieces per box / Pièces par carton / Stücke in einem Karton / Piezas por caja **1**

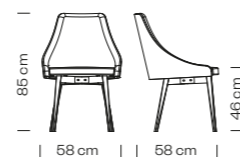

Peso / Weight / Poids / Gewicht / Peso **9,4 kg**

Imballo / Packaging / Emballage / Verpackung / Embalaje **0,34 m³**

Pezzi per scatola / Pieces per box / Pièces par carton / Stücke in einem Karton / Piezas por caja **1**

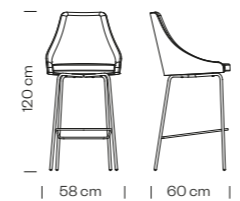

Peso / Weight / Poids / Gewicht / Peso **9,3 kg**

Imballo / Packaging / Emballage / Verpackung / Embalaje **0,44 m³**

Pezzi per scatola / Pieces per box / Pièces par carton / Stücke in einem Karton / Piezas por caja **1**

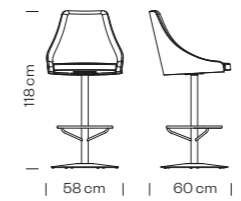

Peso / Weight / Poids / Gewicht / Peso **21,2 kg**

Imballo / Packaging / Emballage / Verpackung / Embalaje **0,44 m³**

Pezzi per scatola / Pieces per box / Pièces par carton / Stücke in einem Karton / Piezas por caja **1**



kyk

design  
Carlo Bimbi Design

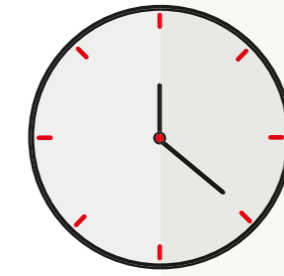
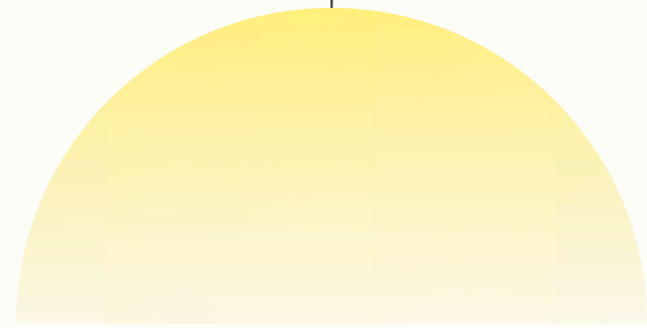



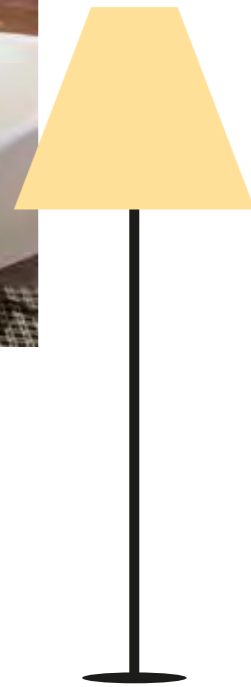

542

- > Poltrona con telaio a 4 gambe in faggio. Sedile e schienale in tessuto.
- > Armchair with beech wood frame, 4 legs. Upholstered seat and back.
- > Fauteuil avec châssis 4 pieds en hêtre. Assise et dossier en tissu.
- > Sessel mit 4-beinigem Buchenholzgestell. Gepolsterte Sitzfläche und Rückenlehne.
- > Sillón con estructura 4 patas en madera de haya. Asiento y respaldo tapizados.

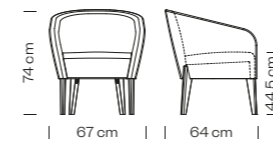

Peso / Weight / Poids / Gewicht / Peso **13 kg**

Imballo / Packaging / Emballage / Verpackung / Embalaje **0,39 m³**

Pezzi per scatola / Pieces per box / Pièces par carton / Stücke in einem Karton / Piezas por caja **1**



543

- > Divano con telaio a 4 gambe in faggio. Sedile e schienale in tessuto.
- > Sofa with beech wood frame, 4 legs. Upholstered seat and back.
- > Canapé avec châssis 4 pieds en hêtre. Assise et dossier en tissu.
- > Sofa mit 4-beinigem Buchenholzgestell. Gepolsterte Sitzfläche und Rückenlehne.
- > Sofa con estructura 4 patas en madera de haya. Asiento y respaldo tapizados.

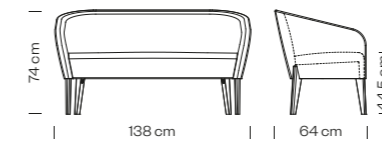

Peso / Weight / Poids / Gewicht / Peso **22 kg**

Imballo / Packaging / Emballage / Verpackung / Embalaje **0,74 m³**

Pezzi per scatola / Pieces per box / Pièces par carton / Stücke in einem Karton / Piezas por caja **1**

TE

- > Finiture seduta (vedi p. 375)
- > Seat finishes (see p. 375)
- > Finitions de l'assise (voir p. 375)
- > Sitzfertigungen (sehen S. 375)
- > Acabados asiento (ver p. 375)

LE

- > Finiture telaio
- > Frame finishes
- > Finitions piètement
- > Gestell Fertigungen
- > Acabados estructura



# uni-ka

design  
rdm

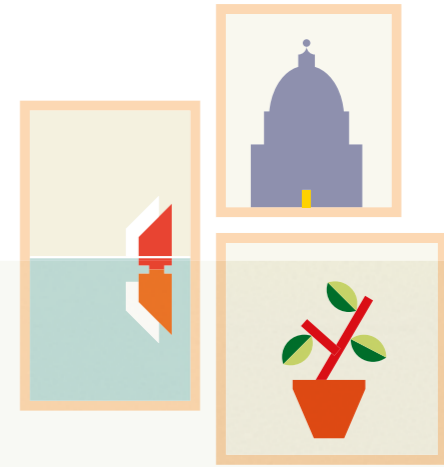



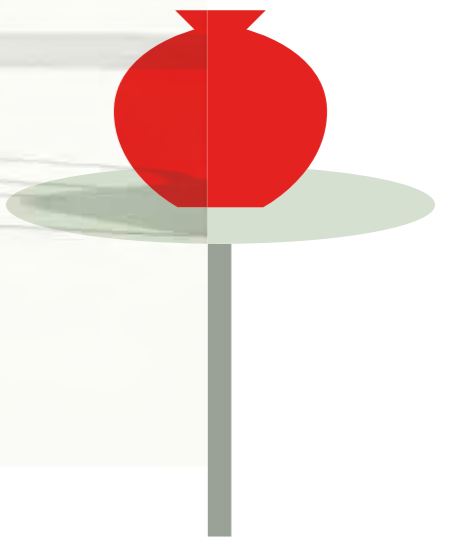





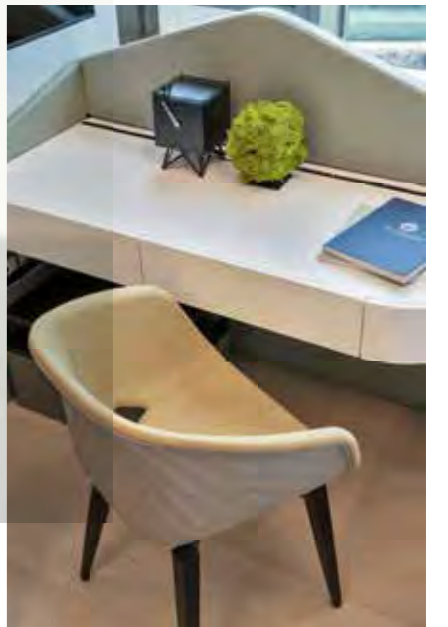
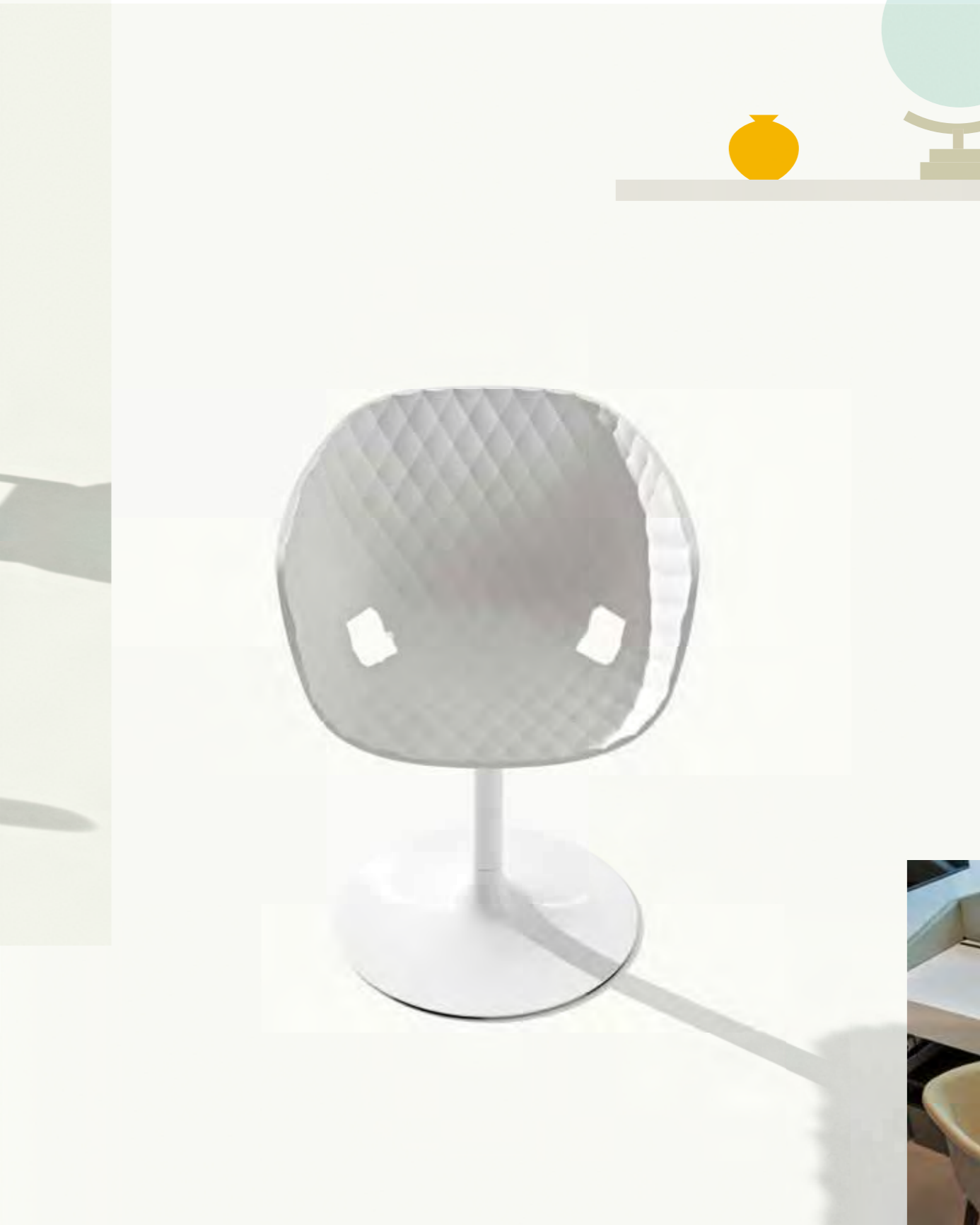



594

- > Poltroncina con telaio 4 gambe in acciaio, seduta in polipropilene.
- > Armchair with steel frame, 4 legs. Polypropylene shell.
- > Fauteuil avec châssis en acier 4 pieds et coque en polypropylène.
- > Armlehnstuhl mit 4-beinigem Stahlgestell. Sitzfläche aus Polypropylen.
- > Sillón con estructura tubular 4 patas en acero, carcasa en polipropileno.



594M

- > Poltroncina con seduta in polipropilene, imbottita. Telaio 4 gambe in tubo acciaio.
- > Armchair with steel frame, 4 legs. Upholstered polypropylene shell.
- > Fauteuil avec châssis en acier 4 pieds et coque en polypropylène rembourrée.
- > Armlehnstuhl mit Sitzfläche aus Polypropylen und Bezug auf Stoff. 4-beiniger Stahlgestell.
- > Sillón con estructura tubular 4 patas en acero, carcasa en polipropileno tapizada.



596

- > Poltroncina con telaio a traliccio in tondino acciaio. Seduta in polipropilene.
- > Armchair with wire steel frame. Polypropylene shell.
- > Fauteuil avec châssis treillis en fil d'acier. Coque en polypropylène.
- > Armlehnstuhl mit Gittergestell aus Stahlstangen. Sitzfläche aus Polypropylen.
- > Sillón con estructura enrejado en acero, carcasa en polipropileno.



596M

- > Poltroncina con seduta in polipropilene, imbottita. Telaio a traliccio in tondino acciaio.
- > Armchair with wire steel frame. Upholstered polypropylene shell.
- > Fauteuil avec châssis treillis en fil d'acier. Coque en polypropylène rembourrée.
- > Armlehnstuhl mit Sitzfläche aus Polypropylen und Bezug aus Stoff. Gittergestell aus Stahlstangen.
- > Sillón con estructura enrejado en acero, carcasa en polipropileno tapizada.



599

- > Poltroncina con telaio 4 gambe in faggio, seduta in polipropilene.
- > Armchair with beech wood frame, 4 legs. Polypropylene shell.
- > Fauteuil avec châssis 4 pieds en hêtre. Coque en polypropylène.
- > Armlehnstuhl mit 4-beinigem Buchenholzgestell. Sitzfläche aus Polypropylen.
- > Sillón con estructura 4 patas en madera de haya. Carcasa en polipropileno.



599M

- > Poltroncina con seduta in polipropilene, imbottita. Telaio 4 gambe in faggio.
- > Armchair with beech wood frame, 4 legs. Upholstered polypropylene shell.
- > Fauteuil avec châssis 4 pieds en hêtre. Coque en polypropylène rembourrée.
- > Armlehnstuhl mit Sitzfläche aus Polypropylen und Bezug aus Stoff. 4-beiniger Buchenholzgestell.
- > Sillón con estructura 4 patas en madera de haya. Carcasa en polipropileno tapizada.



601

- > Poltroncina con telaio 4 gambe in faggio, seduta in polipropilene.
- > Armchair with beech wood frame, 4 legs. Polypropylene shell.
- > Fauteuil avec châssis 4 pieds ronds en hêtre. Coque en polypropylène.
- > Armlehnstuhl mit 4-beinigem Buchenholzgestell. Sitzfläche aus Polypropylen.
- > Sillón con estructura 4 patas redonda en madera de haya. Carcasa en polipropileno.



601M

- > Poltroncina con seduta in polipropilene, imbottita. Telaio 4 gambe in faggio.
- > Armchair with beech wood frame, 4 legs. Upholstered polypropylene shell.
- > Fauteuil avec châssis 4 pieds ronds en hêtre. Coque en polypropylène rembourrée.
- > Armlehnstuhl mit 4-beinigem Buchenholzgestell. Sitzfläche aus Polypropylen und Bezug aus Stoff.
- > Sillón con estructura 4 patas redonda en madera de haya. Carcasa en polipropileno tapizada.

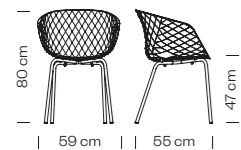

Peso / Weight / Poids / Gewicht / Peso **6,4 kg**

Imballo / Packaging / Emballage / Verpackung / Embalaje **0,42 m³**

Pezzi per scatola / Pieces per box / Pièces par carton / Stücke in einem Karton / Piezas por caja **4**

Impilabile / Stackable / Empilable / Stapelbar / Apilable **4**



Peso / Weight / Poids / Gewicht / Peso **6,9 kg**

Imballo / Packaging / Emballage / Verpackung / Embalaje **0,34 m³**

Pezzi per scatola / Pieces per box / Pièces par carton / Stücke in einem Karton / Piezas por caja **1**



Peso / Weight / Poids / Gewicht / Peso **9,8 kg**

Imballo / Packaging / Emballage / Verpackung / Embalaje **0,34 m³**

Pezzi per scatola / Pieces per box / Pièces par carton / Stücke in einem Karton / Piezas por caja **1**

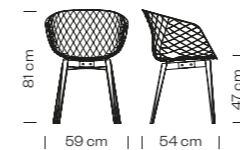

Peso / Weight / Poids / Gewicht / Peso **6,5 kg**

Imballo / Packaging / Emballage / Verpackung / Embalaje **0,34 m³**

Pezzi per scatola / Pieces per box / Pièces par carton / Stücke in einem Karton / Piezas por caja **1**



Peso / Weight / Poids / Gewicht / Peso **9,4 kg**

Imballo / Packaging / Emballage / Verpackung / Embalaje **0,34 m³**

Pezzi per scatola / Pieces per box / Pièces par carton / Stücke in einem Karton / Piezas por caja **1**

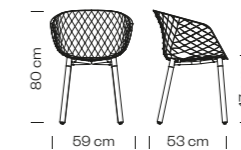

Peso / Weight / Poids / Gewicht / Peso **6,8 kg**

Imballo / Packaging / Emballage / Verpackung / Embalaje **0,34 m³**

Pezzi per scatola / Pieces per box / Pièces par carton / Stücke in einem Karton / Piezas por caja **1**

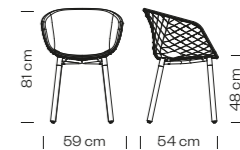

Peso / Weight / Poids / Gewicht / Peso **9,7 kg**

Imballo / Packaging / Emballage / Verpackung / Embalaje **0,34 m³**

Pezzi per scatola / Pieces per box / Pièces par carton / Stücke in einem Karton / Piezas por caja **1**





## 595

- > Poltroncina con telaio a slitta in tondino acciaio. Seduta in polipropilene.
- > Armchair with sled steel frame and polypropylene shell.
- > Fauteuil avec châssis pied luge en fil d'acier. Coque en polypropylène.
- > Armlehnstuhl mit Kufengestell aus Stahlstangen. Sitzfläche aus Polypropylen.
- > Sillón con estructura patín en acero, carcasa en polipropileno.



## 595M

- > Poltroncina con seduta in polipropilene, imbottita. Telaio a slitta in tondino acciaio.
- > Armchair with sled steel frame. Upholstered polypropylene shell.
- > Fauteuil avec châssis pied luge en fil d'acier. Coque en polypropylène rembourrée.
- > Armlehnstuhl mit Sitzfläche aus Polypropylen und Bezug aus Stoff.
- > Sillón con estructura patín en acero, carcasa en polipropileno tapizada.



## 600

- > Poltroncina con telaio a basamento centrale in acciaio, girevole. Seduta in polipropilene.
- > Swivel armchair with central steel base. Polypropylene shell.
- > Fauteuil avec pivotement central pivotant en acier. Coque en polypropylène.
- > Armlehnstuhl mit Untergestell und mittlerem Standfuss aus Stahl, drehbar. Sitzfläche aus Polypropylen.
- > Sillón con estructura columna central en acero, giratoria. Carcasa en polipropileno.



## 600M

- > Poltroncina con seduta in polipropilene, imbottita. Telaio a basamento centrale in acciaio, girevole.
- > Swivel armchair with central steel base. Upholstered polypropylene shell.
- > Fauteuil avec pivotement central pivotant en acier. Coque en polypropylène rembourrée.
- > Armlehnstuhl mit Untergestell und mittlerem Standfuss aus Stahl, drehbar. Sitzfläche aus Polypropylen und Bezug aus Stoff.
- > Sillón con estructura columna central en acero, giratoria. Carcasa en polipropileno tapizada.



## 604

- > Poltroncina lounge con telaio 4 gambe in acciaio, seduta in polipropilene.
- > Lounge armchair with steel frame, 4 legs. Polypropylene shell.
- > Fauteuil lounge avec châssis en acier 4 pieds et coque en polypropylène.
- > Lounge Armlehnstuhl mit 4-beinigem Stahlgestell. Sitzfläche aus Polypropylen.
- > Sillón lounge con estructura 4 patas en acero. Carcasa en polipropileno.



## 604M

- > Poltroncina lounge con seduta in polipropilene, imbottita. Telaio 4 gambe in tubo acciaio.
- > Lounge armchair with steel frame, 4 legs. Upholstered polypropylene shell.
- > Fauteuil lounge avec châssis en acier 4 pieds et coque en polypropylène rembourrée.
- > Lounge Armlehnstuhl mit 4-beinigem Stahlgestell. Sitzfläche aus Polypropylen und Bezug aus Stoff.
- > Sillón lounge con estructura 4 patas en acero. Carcasa en polipropileno tapizada.



## 597-DP

- > Poltroncina con telaio a 5 razze in alluminio, girevole. Seduta in polipropilene. Regolabile in altezza.
- > Swivel armchair with 5 ways aluminium frame. Polypropylene shell. Adjustable seat height.
- > Fauteuil pivotant avec châssis en aluminium 5 branches avec patins. Coque en polypropylène. Réglable en hauteur.
- > Armlehnstuhl mit Aluminiumgestell, drehbar und mit 5-armigem Fusskreuz. Sitzfläche aus Polypropylen. Höhenverstellbar.
- > Sillón con estructura 5 radios en aluminio, giratoria, carcasa en polipropileno. Altura asiento regulable.



## 597M-DP

- > Poltroncina con seduta in polipropilene, imbottita. Telaio a 5 razze in alluminio, girevole. Regolabile in altezza.
- > Swivel armchair with 5 ways aluminium frame. Upholstered polypropylene shell. Adjustable seat height.
- > Fauteuil pivotant avec châssis en aluminium 5 branches avec patins. Coque en polypropylène rembourrée. Réglable en hauteur.
- > Armlehnstuhl mit Aluminiumgestell, drehbar und mit 5-armigem Fusskreuz. Sitzfläche aus Polypropylen und Bezug aus Stoff. Höhenverstellbar.
- > Sillón con estructura 5 radios en aluminio, giratoria, carcasa en polipropileno tapizada. Altura asiento regulable.

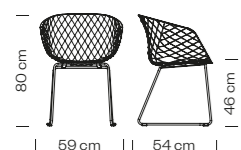

Peso / Weight / Poids / Gewicht / Peso **7,6 kg**

Imballo / Packaging / Emballage / Verpackung / Embalaje **0,34 m³**

Pezzi per scatola / Pieces per box / Pièces par carton / Stücke in einem Karton / Piezas por caja **1**

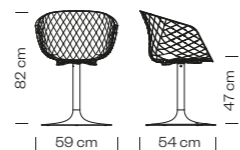

Peso / Weight / Poids / Gewicht / Peso **10,5 kg**

Imballo / Packaging / Emballage / Verpackung / Embalaje **0,34 m³**

Pezzi per scatola / Pieces per box / Pièces par carton / Stücke in einem Karton / Piezas por caja **1**

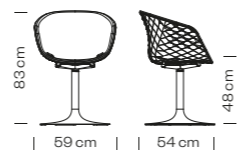

Peso / Weight / Poids / Gewicht / Peso **10,6 kg**

Imballo / Packaging / Emballage / Verpackung / Embalaje **0,34 m³**

Pezzi per scatola / Pieces per box / Pièces par carton / Stücke in einem Karton / Piezas por caja **1**



Peso / Weight / Poids / Gewicht / Peso **6,35 kg**

Imballo / Packaging / Emballage / Verpackung / Embalaje **0,31 m³**

Pezzi per scatola / Pieces per box / Pièces par carton / Stücke in einem Karton / Piezas por caja **1**

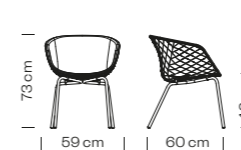

Peso / Weight / Poids / Gewicht / Peso **9,25 kg**

Imballo / Packaging / Emballage / Verpackung / Embalaje **0,31 m³**

Pezzi per scatola / Pieces per box / Pièces par carton / Stücke in einem Karton / Piezas por caja **1**

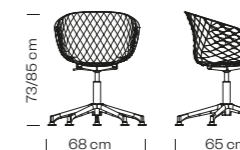

Peso / Weight / Poids / Gewicht / Peso **7,2 kg**

Imballo / Packaging / Emballage / Verpackung / Embalaje **0,39 m³**

Pezzi per scatola / Pieces per box / Pièces par carton / Stücke in einem Karton / Piezas por caja **1**

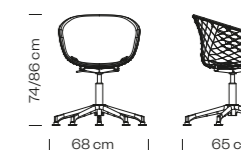

Peso / Weight / Poids / Gewicht / Peso **9,5 kg**

Imballo / Packaging / Emballage / Verpackung / Embalaje **0,39 m³**

Pezzi per scatola / Pieces per box / Pièces par carton / Stücke in einem Karton / Piezas por caja **1**



## 597-DR

- > Poltroncina con telaio a 5 razze in alluminio, girevole, su ruote. Seduta in polipropilene. Regolabile in altezza.
- > Swivel armchair with 5 ways on castors, aluminium frame. Polypropylene shell. Adjustable seat height.
- > Fauteuil pivotant avec châssis en aluminium 5 branches avec roulettes. Coque en polypropylène. Réglable en hauteur.
- > Armlehnstuhl mit Aluminiumgestell, drehbar und mit 5-armigem Fusskreuz und Rollen. Sitzfläche aus Polypropylen. Höhenverstellbar.
- > Sillón con estructura 5 radios en aluminio, giratoria, con ruedas, carcasa en polipropileno. Altura asiento regulable.

360°

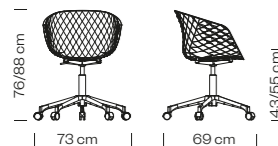

Peso / Weight / Poids / Gewicht / Peso **7,2 kg**

Imballo / Packaging / Emballage / Verpackung / Embalaje **0,39 m³**

Pezzi per scatola / Pieces per box / Pièces par carton / Stücke in einem Karton / Piezas por caja **1**



## 597M-DR

- > Poltroncina con seduta in polipropilene, imbottita. Telaio a 5 razze in alluminio, girevole, su ruote. Regolabile in altezza.
- > Swivel armchair with 5 ways on castors, aluminium frame. Upholstered polypropylene shell. Adjustable seat height.
- > Fauteuil pivotant avec châssis en aluminium 5 branches avec roulettes. Coque en polypropylène rembourrée. Réglable en hauteur.
- > Armlehnstuhl mit Aluminiumgestell, drehbar und mit 5-armigem Fusskreuz und Rollen. Sitzfläche aus Polypropylen und Bezug auf Stoff. Höhenverstellbar.
- > Sillón con estructura 5 radios en aluminio, giratoria, con ruedas, carcasa en polipropileno tapizada. Altura asiento regulable.

360°



Peso / Weight / Poids / Gewicht / Peso **9,5 kg**

Imballo / Packaging / Emballage / Verpackung / Embalaje **0,39 m³**

Pezzi per scatola / Pieces per box / Pièces par carton / Stücke in einem Karton / Piezas por caja **1**

## TE

- > Finiture seduta (vedi p. 375)
- > Seat finishes (see p. 375)
- > Finitions de l'assise (voir p. 375)
- > Sitzfertigungen (sehen S. 375)
- > Acabados asiento (ver p. 375)

## PP

- > Finiture seduta
- > Seat finishes
- > Finitions de l'assise
- > Sitzfertigungen
- > Acabados asiento



## AC

- > Finiture telaio (vedi p. 397)
- > Frame finishes (see p. 397)
- > Finitions piètement (voir p. 397)
- > Gestell Fertigungen (sehen S. 397)
- > Acabados estructura (ver p. 397)

## AL VR

- > Finiture telaio
- > Frame finishes
- > Finitions piètement
- > Gestell Fertigungen
- > Acabados estructura



## AL PSH

- > Finiture telaio (vedi p. 399)
- > Frame finishes (see p. 399)
- > Finitions piètement (voir p. 399)
- > Gestell Fertigungen (sehen S. 399)
- > Acabados estructura (ver p. 399)

## LE

- > Finiture telaio
- > Frame finishes
- > Finitions piètement
- > Gestell Fertigungen
- > Acabados estructura



# uni

design  
**Francesco Geraci**

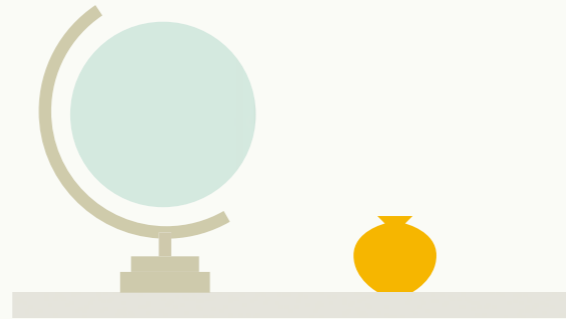















## 550

- > Sedia con telaio a 4 gambe in tubo acciaio. Seduta in polipropilene.
- > Chair with steel frame, 4 legs. Polypropylene shell.
- > Chaise avec châssis en acier 4 pieds et coque en polypropylène.
- > Stuhl mit 4-beinigem Stahlgestell. Sitzfläche aus Polypropylen.
- > Silla con estructura tubular 4 patas en acero, carcasa en polipropileno.



## 550M

- > Sedia con seduta in polipropilene, imbottita. Telaio a 4 gambe in tubo acciaio.
- > Chair with steel frame, 4 legs. Upholstered polypropylene shell.
- > Chaise avec châssis en acier 4 pieds et coque en polypropylène rembourrée.
- > Stuhl mit Sitzfläche aus Polypropylen und Bezug auf Stoff. 4-beiniger Stahlgestell.
- > Silla con estructura tubular 4 patas en acero, carcasa en polipropileno tapizada.



## 378

- > Sgabello con telaio a 4 gambe in tubo acciaio. Seduta in polipropilene.
- > Barstool with steel frame, 4 legs. Polypropylene shell.
- > Tabouret avec chassis 4 pieds en acier. Coque en polypropylène.
- > Barhocker mit 4-beinigem Stahlgestell. Schale aus Polypropylen.
- > Taburete con estructura tubular 4 patas en acero, carcasa en polipropileno.



## 378B

- > Sgabello con telaio a 4 gambe in tubo acciaio. Seduta in polipropilene. Versione seduta H 65 cm.
- > Barstool with steel frame, 4 legs. Polypropylene shell. Version with seat-height H 65 cm.
- > Tabouret avec chassis 4 pieds en acier. Coque en polypropylène. Version hauteur assise 65 cm.
- > Barhocker mit 4-beinigem Stahlgestell. Schale aus Polypropylen. Sitzhöhe 65 cm.
- > Taburete con estructura tubular 4 patas en acero, carcasa en polipropileno. Altura asiento 65 cm.



## 378M

- > Sgabello con seduta in polipropilene, imbottita. Telaio a 4 gambe in tubo acciaio.
- > Barstool with steel frame, 4 legs. Upholstered polypropylene shell.
- > Tabouret avec chassis 4 pieds en acier. Coque en polypropylène rembourrée.
- > Barhocker mit Sitzfläche aus Polypropylen und Bezug auf Stoff. Gestell mit 4-beinigem Stahlrohren.
- > Taburete con estructura tubular 4 patas en acero, carcasa en polipropileno tapizada.



## 380

- > Sgabello con telaio a basamento centrale girevole in acciaio, con meccanismo di ritorno. Seduta in polipropilene.
- > Swivel barstool with central steel base and kick-back device. Polypropylene shell.
- > Tabouret avec pietement central pivotant en acier avec mecanisme de retour. Coque en polypropylène.
- > Barhocker mit Untergestell und mittlerem Standfuss aus Stahl mit Rueckdrehautomatik. Sitzfläche aus Polypropylen.
- > Taburete con estructura columna central en acero, con sistema de vuelta. Carcasa en polipropileno.



## 380B

- > Sgabello con telaio a basamento centrale girevole in acciaio, con meccanismo di ritorno. Seduta in polipropilene. Versione seduta H 65 cm.
- > Swivel barstool with central steel base and kick-back device. Polypropylene shell. Version seat-height H 65 cm.
- > Tabouret avec pietement central pivotant en acier avec mecanisme de retour. Coque en polypropylène. Version hauteur assise 65 cm.
- > Barhocker mit Untergestell und mittlerem Standfuss aus Stahl mit Rueckdrehautomatik. Sitzfläche aus Polypropylen.
- > Taburete con estructura columna central en acero, con sistema de vuelta. Carcasa en polipropileno. Altura asiento 65 cm.



## 380M

- > Sgabello con seduta in polipropilene, imbottita. Telaio a basamento centrale girevole in acciaio e meccanismo di ritorno.
- > Swivel barstool with central steel base and kick-back device. Upholstered polypropylene shell.
- > Tabouret avec pietement central pivotant en acier avec mecanisme de retour. Coque en polypropylène rembourrée.
- > Barhocker mit Sitzfläche aus Polypropylen und Bezug auf Stoff. Gestell mit mittlerem Standfuss aus Stahl und Rueckdrehautomatik.
- > Taburete con estructura columna central en acero, con sistema de vuelta. Carcasa en polipropileno tapizada.

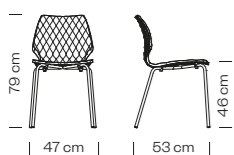

Peso / Weight / Poids / Gewicht / Peso **4,6 kg**

Imballo / Packaging / Emballage / Verpackung / Embalaje **0,36 m³**

Pezzi per scatola / Pieces per box / Pièces par carton / Stücke in einem Karton / Piezas por caja **5**

Impilabile / Stackable / Empilable / Stapelbar / Apilable **8**



Peso / Weight / Poids / Gewicht / Peso **6,75 kg**

Imballo / Packaging / Emballage / Verpackung / Embalaje **0,24 m³**

Pezzi per scatola / Pieces per box / Pièces par carton / Stücke in einem Karton / Piezas por caja **1**

Impilabile / Stackable / Empilable / Stapelbar / Apilable **4**



Peso / Weight / Poids / Gewicht / Peso **6,8 kg**

Imballo / Packaging / Emballage / Verpackung / Embalaje **0,46 m³**

Pezzi per scatola / Pieces per box / Pièces par carton / Stücke in einem Karton / Piezas por caja **4**

Impilabile / Stackable / Empilable / Stapelbar / Apilable **4**



Peso / Weight / Poids / Gewicht / Peso **6,5 kg**

Imballo / Packaging / Emballage / Verpackung / Embalaje **0,46 m³**

Pezzi per scatola / Pieces per box / Pièces par carton / Stücke in einem Karton / Piezas por caja **4**

Impilabile / Stackable / Empilable / Stapelbar / Apilable **4**

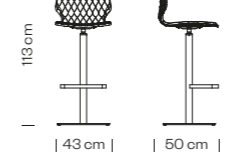

Peso / Weight / Poids / Gewicht / Peso **8,95 kg**

Imballo / Packaging / Emballage / Verpackung / Embalaje **0,35 m³**

Pezzi per scatola / Pieces per box / Pièces par carton / Stücke in einem Karton / Piezas por caja **1**

Impilabile / Stackable / Empilable / Stapelbar / Apilable **1**

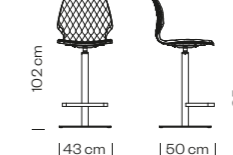

Peso / Weight / Poids / Gewicht / Peso **17 kg**

Imballo / Packaging / Emballage / Verpackung / Embalaje **0,29 m³**

Pezzi per scatola / Pieces per box / Pièces par carton / Stücke in einem Karton / Piezas por caja **1**

Impilabile / Stackable / Empilable / Stapelbar / Apilable **1**

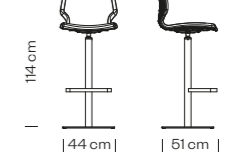

Peso / Weight / Poids / Gewicht / Peso **16,7 kg**

Imballo / Packaging / Emballage / Verpackung / Embalaje **0,29 m³**

Pezzi per scatola / Pieces per box / Pièces par carton / Stücke in einem Karton / Piezas por caja **1**

Impilabile / Stackable / Empilable / Stapelbar / Apilable **1**



562

- > Sedia con telaio a 4 gambe in faggio. Seduta in polipropilene.
- > Chair with beech wood frame, 4 legs. Polypropylene shell.
- > Chaise avec châssis 4 pieds en hêtre. Coque en polypropylène.
- > Stuhl mit 4-beinigem Buchenholzgestell. Sitzfläche aus Polypropylen.
- > Silla con estructura 4 patas en madera de haya. Carcasa en polipropileno.



562M

- > Sedia con seduta in polipropilene, imbottita. Telaio a 4 gambe in faggio.
- > Chair with beech wood frame, 4 legs. Upholstered polypropylene shell.
- > Chaise avec châssis 4 pieds en hêtre. Coque en polypropylène rembourrée.
- > Stuhl mit Sitzfläche aus Polypropylen und Bezug aus Stoff. 4-beiniger Buchenholzgestell.
- > Silla con estructura 4 patas en madera de haya. Carcasa en polipropileno tapizada.



386

- > Sgabello con telaio a 4 gambe in faggio. Seduta in polipropilene.
- > Barstool with beech wood frame, 4 legs. Polypropylene shell.
- > Tabouret avec châssis 4 pieds en hêtre. Coque en polypropylène.
- > Barhocker mit 4-beinigem Buchenholzgestell. Sitzfläche aus Polypropylen.
- > Taburete con estructura 4 patas en madera de haya. Carcasa en polipropileno.



386M

- > Sgabello con seduta in polipropilene, imbottita. Telaio 4 gambe in faggio.
- > Barstool with beech wood frame, 4 legs. Upholstered polypropylene shell.
- > Tabouret avec châssis 4 pieds en hêtre. Coque en polypropylène rembourrée.
- > Barhocker mit Sitzfläche aus Polypropylen und Bezug auf Stoff. 4-beiniger Buchenholzgestell.
- > Taburete con estructura 4 patas en madera de haya. Carcasa en polipropileno tapizada.



577

- > Sedia con telaio 4 gambe tonde in faggio. Seduta in polipropilene.
- > Chair with beech wood frame, 4 rounded legs. Polypropylene shell.
- > Chaise avec châssis 4 pieds ronds en hêtre. Coque en polypropylène.
- > Stuhl mit Gestell aus 4 runden Buchenholzbeine. Sitzfläche aus Polypropylen.
- > Silla con estructura 4 patas redonda en madera de haya. Carcasa en polipropileno.



577M

- > Sedia con seduta in polipropilene, imbottita. Telaio 4 gambe tonde in faggio.
- > Chair with beech wood frame, 4 rounded legs. Upholstered polypropylene shell.
- > Chaise avec châssis 4 pieds ronds en hêtre. Coque en polypropylène rembourrée.
- > Stuhl mit Gestell aus 4 runden Buchenholzbeine. Sitzfläche aus Polypropylen und Bezug aus Stoff.
- > Silla con estructura 4 patas redonda en madera de haya. Carcasa en polipropileno tapizada.



393

- > Sgabello con seduta in polipropilene, telaio 4 gambe tonde in faggio.
- > Barstool with wooden frame, 4 round legs. Polypropylene shell.
- > Tabouret avec châssis 4 pieds ronds en hêtre. Coque en polypropylène.
- > Barhocker mit Sitzfläche aus Polypropylen. 4-beiniger Buchenholzgestell.
- > Taburete con estructura 4 patas redonda en madera de haya. Carcasa en polipropileno.



393M

- > Sgabello con seduta in polipropilene, imbottita. Telaio 4 gambe tonde in faggio.
- > Barstool with wooden frame, 4 round legs. Upholstered polypropylene shell.
- > Tabouret avec châssis 4 pieds ronds en hêtre. Coque en polypropylène rembourrée.
- > Barhocker mit Sitzfläche aus Polypropylen und Bezug auf Stoff. 4-beiniger Buchenholzgestell.
- > Taburete con estructura 4 patas redonda en madera de haya. Carcasa en polipropileno tapizada.

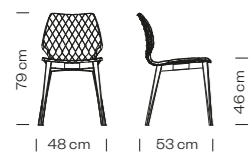

Peso / Weight / Poids / Gewicht / Peso **4,5 kg**

Imballo / Packaging / Emballage / Verpackung / Embalaje **0,28 m³**

Pezzi per scatola / Pieces per box / Pièces par carton / Stücke in einem Karton / Piezas por caja **2**



Peso / Weight / Poids / Gewicht / Peso **6,7 kg**

Imballo / Packaging / Emballage / Verpackung / Embalaje **0,24 m³**

Pezzi per scatola / Pieces per box / Pièces par carton / Stücke in einem Karton / Piezas por caja **1**

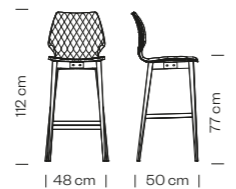

Peso / Weight / Poids / Gewicht / Peso **6,3 kg**

Imballo / Packaging / Emballage / Verpackung / Embalaje **0,35 m³**

Pezzi per scatola / Pieces per box / Pièces par carton / Stücke in einem Karton / Piezas por caja **1**

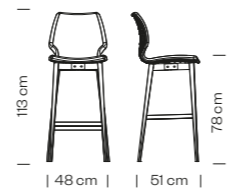

Peso / Weight / Poids / Gewicht / Peso **8,45 kg**

Imballo / Packaging / Emballage / Verpackung / Embalaje **0,35 m³**

Pezzi per scatola / Pieces per box / Pièces par carton / Stücke in einem Karton / Piezas por caja **1**



Peso / Weight / Poids / Gewicht / Peso **4,7 kg**

Imballo / Packaging / Emballage / Verpackung / Embalaje **0,30 m³**

Pezzi per scatola / Pieces per box / Pièces par carton / Stücke in einem Karton / Piezas por caja **2**



Peso / Weight / Poids / Gewicht / Peso **6,85 kg**

Imballo / Packaging / Emballage / Verpackung / Embalaje **0,24 m³**

Pezzi per scatola / Pieces per box / Pièces par carton / Stücke in einem Karton / Piezas por caja **1**

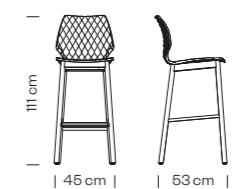

Peso / Weight / Poids / Gewicht / Peso **6,6 kg**

Imballo / Packaging / Emballage / Verpackung / Embalaje **0,35 m³**

Pezzi per scatola / Pieces per box / Pièces par carton / Stücke in einem Karton / Piezas por caja **1**

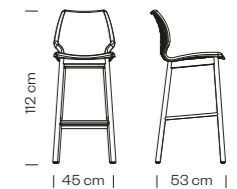

Peso / Weight / Poids / Gewicht / Peso **8,75 kg**

Imballo / Packaging / Emballage / Verpackung / Embalaje **0,35 m³**

Pezzi per scatola / Pieces per box / Pièces par carton / Stücke in einem Karton / Piezas por caja **1**



551

- > Sedia con telaio a 4 gambe in tubo acciaio, con braccioli. Seduta in polipropilene.
- > Chair with armrests and steel frame, 4 legs. Polypropylene shell.
- > Chaise avec châssis en acier 4 pieds et accoudoirs. Coque en polypropylène.
- > Armlehnstuhl mit 4-beinigem Stahlgestell. Sitzfläche aus Polypropylen.
- > Silla con estructura tubular 4 patas en acero con brazos, carcasa en polipropileno.



551M

- > Sedia con seduta in polipropilene, imbottita. Telaio a 4 gambe in tubo acciaio, con braccioli.
- > Chair with armrests and steel frame, 4 legs. Upholstered polypropylene shell.
- > Chaise avec châssis en acier 4 pieds et accoudoirs. Coque en polypropylène rembourrée.
- > Armlehnstuhl mit Sitzfläche aus Polypropylen und Bezug auf Stoff. 4-beinigem Stahlgestell.
- > Silla con estructura tubular 4 patas en acero con brazos, carcasa en polipropileno tapizada.



553

- > Sedia con telaio a traliccio in tondino acciaio. Seduta in polipropilene.
- > Chair with wire steel frame. Polypropylene shell.
- > Chaise avec châssis treillis en fil d'acier. Coque en polypropylène.
- > Stuhl mit Gittergestell aus Stahlstangen. Sitzfläche aus Polypropylen.
- > Silla con estructura enrejado en acero, carcasa en polipropileno.



553M

- > Sedia con seduta in polipropilene, imbottita. Telaio a traliccio in tondino acciaio.
- > Chair with wire steel frame. Upholstered polypropylene shell.
- > Chaise avec châssis treillis en fil d'acier. Coque en polypropylène rembourrée.
- > Stuhl mit Gittergestell aus Stahlstangen. Sitzfläche aus Polypropylen und Bezug aus Stoff.
- > Silla con estructura enrejado en acero, carcasa en polipropileno, tapizada.



603

- > Sedia con telaio a basamento centrale in acciaio, girevole. Seduta in polipropilene.
- > Swivel chair with central steel base and polypropylene shell.
- > Chaise avec pivotement central pivotant en acier. Coque en polypropylène.
- > Stuhl mit Untergestell und mittlerem Standfuss aus Stahl, drehbar. Sitzfläche aus Polypropylen.
- > Silla con estructura columna central en acero, giratoria. Carcasa en polipropileno.



603M

- > Sedia con seduta in polipropilene, imbottita. Telaio a basamento centrale in acciaio, girevole.
- > Swivel chair with central steel base. Upholstered polypropylene shell.
- > Chaise avec pivotement central pivotant en acier. Coque en polypropylène rembourrée.
- > Stuhl mit Untergestell und mittlerem Standfuss aus Stahl, drehbar. Sitzfläche aus Polypropylen und Bezug aus Stoff.
- > Silla con estructura columna central en acero, giratoria. Carcasa en polipropileno tapizada.



602

- > Sedia con telaio a 4 gambe tonde in faggio. Seduta in polipropilene.
- > Chair with beech wood frame, 4 rounded legs. Polypropylene shell.
- > Chaise avec châssis 4 pieds ronds en hêtre. Coque en polypropylène.
- > Stuhl mit Gestell aus 4 runden Buchenholzbeine. Sitzfläche aus Polypropylen.
- > Silla con estructura 4 patas redonda en madera de haya. Carcasa en polipropileno.



602M

- > Sedia con seduta in polipropilene, imbottita. Telaio 4 gambe tonde in faggio.
- > Chair with beech wood frame, 4 rounded legs. Upholstered polypropylene shell.
- > Chaise avec châssis 4 pieds ronds en hêtre. Coque en polypropylène rembourrée.
- > Stuhl mit Sitzfläche aus Stoff. Gestell aus 4 runden Buchenholzbeine.
- > Silla con estructura 4 patas redonda en madera de haya. Carcasa en polipropileno tapizada.

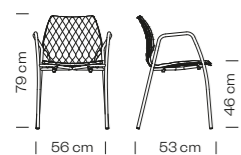

Peso / Weight / Poids / Gewicht / Peso **5,5 kg**

Imballo / Packaging / Emballage / Verpackung / Embalaje **0,39 m³**

Pezzi per scatola / Pieces per box / Pièces par carton / Stücke in einem Karton / Piezas por caja **4**

Impilabile / Stackable / Empilable / Stapelbar / Apilable **4**



Peso / Weight / Poids / Gewicht / Peso **7,65 kg**

Imballo / Packaging / Emballage / Verpackung / Embalaje **0,39 m³**

Pezzi per scatola / Pieces per box / Pièces par carton / Stücke in einem Karton / Piezas por caja **1**

Impilabile / Stackable / Empilable / Stapelbar / Apilable **4**

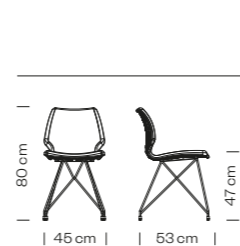

Peso / Weight / Poids / Gewicht / Peso **5 kg**

Imballo / Packaging / Emballage / Verpackung / Embalaje **0,30 m³**

Pezzi per scatola / Pieces per box / Pièces par carton / Stücke in einem Karton / Piezas por caja **2**

Impilabile / Stackable / Empilable / Stapelbar / Apilable **4**

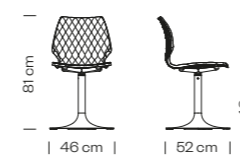

Peso / Weight / Poids / Gewicht / Peso **8,3 kg**

Imballo / Packaging / Emballage / Verpackung / Embalaje **0,24 m³**

Pezzi per scatola / Pieces per box / Pièces par carton / Stücke in einem Karton / Piezas por caja **1**

Impilabile / Stackable / Empilable / Stapelbar / Apilable **4**



Peso / Weight / Poids / Gewicht / Peso **10,4 kg**

Imballo / Packaging / Emballage / Verpackung / Embalaje **0,24 m³**

Pezzi per scatola / Pieces per box / Pièces par carton / Stücke in einem Karton / Piezas por caja **1**

Impilabile / Stackable / Empilable / Stapelbar / Apilable **4**



Peso / Weight / Poids / Gewicht / Peso **4,5 kg**

Imballo / Packaging / Emballage / Verpackung / Embalaje **0,33 m³**

Pezzi per scatola / Pieces per box / Pièces par carton / Stücke in einem Karton / Piezas por caja **2**

Impilabile / Stackable / Empilable / Stapelbar / Apilable **4**



Peso / Weight / Poids / Gewicht / Peso **6,65 kg**

Imballo / Packaging / Emballage / Verpackung / Embalaje **0,24 m³**

Pezzi per scatola / Pieces per box / Pièces par carton / Stücke in einem Karton / Piezas por caja **1**

Impilabile / Stackable / Empilable / Stapelbar / Apilable **4**





## 552

- > Sedia con telaio a slitta in tondino acciaio. Seduta in polipropilene.
- > Chair with sled steel frame. Polypropylene shell.
- > Chaise avec châssis en fil d'acier pied luge. Coque en polypropylène.
- > Stuhl mit Kufengestell aus Stahlstangen. Sitzfläche aus Polypropylen.
- > Silla con estructura patín en acero, carcasa en polipropileno.



## 552M

- > Sedia con seduta in polipropilene, imbottita. Telaio a slitta in tondino acciaio.
- > Chair with sled steel frame and upholstered polypropylene shell.
- > Chaise avec châssis en fil d'acier pied luge. Coque en polypropylène rembourrée.
- > Stuhl mit Sitzfläche aus Polypropylen und Bezug aus Stoff. Kufengestell aus Stahlstangen.
- > Silla con estructura patín en acero, carcasa en polipropileno tapizada.



## 552-G

- > Sedia con telaio a slitta in tondino acciaio e sistema di aggancio. Seduta in polipropilene.
- > Chair with sled steel frame and linking device. Polypropylene shell.
- > Chaise avec châssis en fil d'acier pied luge et système d'accrochage. Coque en polypropylène.
- > Stuhl mit Kufengestell aus Stahlstangen und Verbindungssystem. Sitzfläche aus Polypropylen.
- > Silla con estructura patín en acero y sistema de enganche, carcasa en polipropileno.



## 552M-G

- > Sedia con seduta in polipropilene, imbottita. Telaio a slitta in tondino acciaio e sistema di aggancio.
- > Chair with sled steel frame and linking device. Upholstered polypropylene shell.
- > Chaise avec châssis en fil d'acier pied luge et système d'accrochage. Coque en polypropylène rembourrée.
- > Stuhl mit Sitzfläche aus Polypropylen und Bezug aus Stoff. Kufengestell aus Stahlstangen mit Verbindungssystem.
- > Silla con estructura patín en acero y sistema de enganche, carcasa en polipropileno tapizada.



## 552-T

- > Sedia con telaio a slitta in tondino acciaio, con tavoletta conferenza antipánico. Seduta in polipropilene.
- > Chair with steel sled frame with conference desk kit. Polypropylene shell.
- > Chaise avec châssis pied luge en fil d'acier équipée de tablette amovible. Coque en polypropylène.
- > Stuhl mit Kufengestell aus Stahlstangen. ausgelegt für Konferenzraumausstattung mit Schreibpult. Sitzfläche aus Polypropylen.
- > Silla con estructura patín en acero con tableta conferencia antipánico, carcasa en polipropileno.



## 552-GT

- > Sedia con telaio a slitta in tondino acciaio e sistema di aggancio, con tavoletta conferenza antipánico. Seduta in polipropilene.
- > Chair with steel sled frame and linking device with conference desk kit. Polypropylene shell.
- > Chaise avec châssis pied luge en fil d'acier équipée de tablette amovible et système d'accrochage.
- > Stuhl mit Kufengestell aus Stahlstangen ausgelegt für Konferenzraumausstattung mit Verbindungssystem und Schreibpult. Sitzfläche aus Polypropylen.
- > Silla con estructura patín en acero y sistema de enganche, con tableta conferencia antipánico. Carcasa en polipropileno.



## 391

- > Sgabello con telaio a slitta in acciaio, seduta in polipropilene.
- > Barstool with steel sled frame, polypropylene shell.
- > Tabouret avec chassis pied luge en fil d'acier. Coque en polypropylène.
- > Barhocker mit Kufengestell aus Stahl. Sitzfläche aus Polypropylen.
- > Taburete con estructura patín en acero, carcasa en polipropileno.



## 391M

- > Sgabello con seduta in polipropilene, imbottita. Telaio a slitta in tondino acciaio.
- > Barstool with steel sled frame, upholstered polypropylene shell.
- > Tabouret avec chassis pied luge en fil d'acier. Coque en polypropylène rembourrée.
- > Barhocker mit Sitzfläche aus Polypropylen und Bezug auf Stoff. Kufengestell aus Stahl.
- > Taburete con estructura patín en acero, carcasa en polipropileno tapizada.

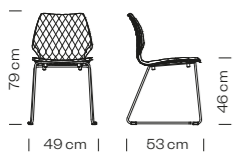

Peso / Weight / Poids / Gewicht / Peso **6,3 kg**

Imballo / Packaging / Emballage / Verpackung / Embalaje **0,39 m³**

Pezzi per scatola / Pieces per box / Pièces par carton / Stücke in einem Karton / Piezas por caja **4**

Impilabile / Stackable / Empilable / Stapelbar / Apilable **4**



Peso / Weight / Poids / Gewicht / Peso **8,4 kg**

Imballo / Packaging / Emballage / Verpackung / Embalaje **0,34 m³**

Pezzi per scatola / Pieces per box / Pièces par carton / Stücke in einem Karton / Piezas por caja **1**



Peso / Weight / Poids / Gewicht / Peso **6,4 kg**

Imballo / Packaging / Emballage / Verpackung / Embalaje **0,39 m³**

Pezzi per scatola / Pieces per box / Pièces par carton / Stücke in einem Karton / Piezas por caja **4**

Impilabile / Stackable / Empilable / Stapelbar / Apilable **4**

Sistema di aggancio / Linking device / Système d'accrochage / Verbindungssystem / Sistema de enganche

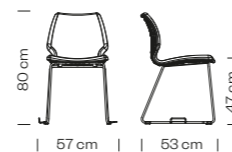

Peso / Weight / Poids / Gewicht / Peso **8,5 kg**

Imballo / Packaging / Emballage / Verpackung / Embalaje **0,34 m³**

Pezzi per scatola / Pieces per box / Pièces par carton / Stücke in einem Karton / Piezas por caja **1**

Sistema di aggancio / Linking device / Système d'accrochage / Verbindungssystem / Sistema de enganche



Peso / Weight / Poids / Gewicht / Peso **7,8 kg**

Imballo / Packaging / Emballage / Verpackung / Embalaje **0,39 m³**

Pezzi per scatola / Pieces per box / Pièces par carton / Stücke in einem Karton / Piezas por caja **4**



Peso / Weight / Poids / Gewicht / Peso **7,9 kg**

Imballo / Packaging / Emballage / Verpackung / Embalaje **0,39 m³**

Pezzi per scatola / Pieces per box / Pièces par carton / Stücke in einem Karton / Piezas por caja **4**

Sistema di aggancio / Linking device / Système d'accrochage / Verbindungssystem / Sistema de enganche

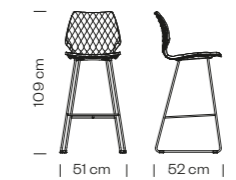

Peso / Weight / Poids / Gewicht / Peso **5,1 kg**

Imballo / Packaging / Emballage / Verpackung / Embalaje **0,35 m³**

Pezzi per scatola / Pieces per box / Pièces par carton / Stücke in einem Karton / Piezas por caja **1**

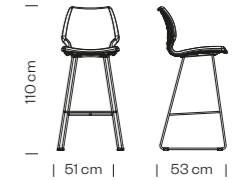

Peso / Weight / Poids / Gewicht / Peso **7,25 kg**

Imballo / Packaging / Emballage / Verpackung / Embalaje **0,35 m³**

Pezzi per scatola / Pieces per box / Pièces par carton / Stücke in einem Karton / Piezas por caja **1**



## 220

- > Sistema sedute su barra a 2 posti con pianetto, telaio in acciaio. Seduta in polipropilene.
- > Seating system on bar, 2 seats with shelf; steel frame, polypropylene seat.
- > Système d'assise sur poutre. Assise en polypropylène, châssis en acier. Version 2 places + tablette.
- > Sitzsystem auf Balken, 2 Sitzplätze mit Ablagefläche. Gestell aus Stahl. Sitzfläche aus Polypropylen.
- > Sistema de asientos en barra, 2 asientos y mesa, estructura en acero. Carcasa en polipropileno.



## 221

- > Sistema sedute su barra a 3 posti, telaio in acciaio. Seduta in polipropilene.
- > Seating system on bar, 3 seats; steel frame, polypropylene seat.
- > Système d'assise sur poutre. Assise en polypropylène, châssis en acier. Version 3 places.
- > Sitzsystem auf Balken, 3 Sitzplätze. Gestell aus Stahl. Sitzfläche aus Polypropylen.
- > Sistema de asientos en barra, 3 asientos, estructura en acero. Carcasa en polipropileno.



## 222

- > Sistema sedute su barra a 3 posti con pianetto, telaio in acciaio. Seduta in polipropilene.
- > Seating system on bar, 3 seats with shelf; steel frame, polypropylene seat.
- > Système d'assise sur poutre. Assise en polypropylène, châssis en acier. Version 3 places + tablette.
- > Sitzsystem auf Balken, 3 Sitzplätze mit Ablagefläche. Gestell aus Stahl. Sitzfläche aus Polypropylen.
- > Sistema de asientos en barra, 3 asientos y mesa, estructura en acero. Carcasa en polipropileno.



## 223

- > Sistema sedute su barra a 4 posti, telaio in acciaio. Seduta in polipropilene.
- > Seating system on bar, 4 seats; steel frame, polypropylene seat.
- > Système d'assise sur poutre. Assise en polypropylène, châssis en acier. Version 4 places.
- > Sitzsystem auf Balken, 4 Sitzplätze. Gestell aus Stahl. Sitzfläche aus Polypropylen.
- > Sistema de asientos en barra, 4 asientos, estructura en acero. Carcasa en polipropileno.

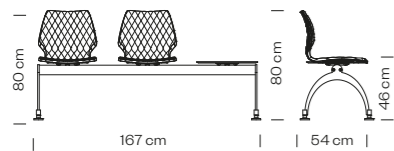

Peso / Weight / Poids / Gewicht / Peso **24,6 kg**

Imballo / Packaging / Emballage / Verpackung / Embalaje **0,89 m³**

Pezzi per scatola / Pieces per box / Pièces par carton / Stücke in einem Karton / Piezas por caja **1**

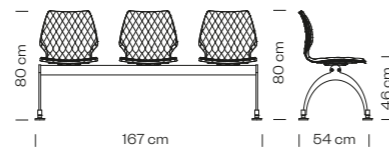

Peso / Weight / Poids / Gewicht / Peso **23 kg**

Imballo / Packaging / Emballage / Verpackung / Embalaje **0,89 m³**

Pezzi per scatola / Pieces per box / Pièces par carton / Stücke in einem Karton / Piezas por caja **1**

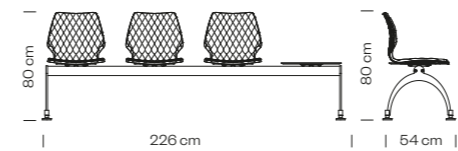

Peso / Weight / Poids / Gewicht / Peso **29,1 kg**

Imballo / Packaging / Emballage / Verpackung / Embalaje **1,25 m³**

Pezzi per scatola / Pieces per box / Pièces par carton / Stücke in einem Karton / Piezas por caja **1**

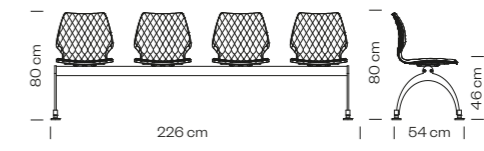

Peso / Weight / Poids / Gewicht / Peso **27,5 kg**

Imballo / Packaging / Emballage / Verpackung / Embalaje **1,25 m³**

Pezzi per scatola / Pieces per box / Pièces par carton / Stücke in einem Karton / Piezas por caja **1**



## 558-DP

- > Sedia con telaio a 5 razze in alluminio, girevole. Seduta in polipropilene. Regolabile in altezza.
- > Swivel chair with 5 ways aluminium frame. Polypropylene shell. Adjustable seat height.
- > Chaise pivotant avec châssis en aluminium 5 branches avec patins. Coque en polypropylène. Réglable en hauteur.
- > Stuhl mit Aluminiumgestell, drehbar und mit 5-armigem Fusskreuz. Sitzfläche aus Polypropylen. Höhenverstellbar.
- > Silla con estructura 5 radios en aluminio, giratoria, carcasa en polipropileno. Altura asiento regulable.



## 558M-DP

- > Sedia con seduta in polipropilene, imbottita. Telaio a 5 razze in alluminio, girevole. Regolabile in altezza.
- > Swivel chair with 5 ways, aluminium frame. Upholstered polypropylene shell. Adjustable seat height.
- > Chaise pivotant avec châssis en aluminium 5 branches avec patins. Coque en polypropylène rembourrée. Réglable en hauteur.
- > Stuhl mit Sitzfläche aus Polypropylen und Bezug aus Stoff. Aluminium Gestell mit 5-armigem Fusskreuz. Höhenverstellbar.
- > Silla con estructura 5 radios en aluminio, giratoria, carcasa en polipropileno tapizada. Altura asiento regulable.



## 558-DR

- > Sedia con telaio a 5 razze in alluminio, girevole, su ruote. Seduta in polipropilene. Regolabile in altezza.
- > Swivel chair with 5 ways on castors, aluminium frame. Upholstered polypropylene shell. Adjustable seat height.
- > Chaise pivotant avec châssis en aluminium 5 branches avec roulettes. Coque en polypropylène. Réglable en hauteur.
- > Stuhl mit Aluminiumgestell, drehbar und mit 5-armigem Fusskreuz und Rollen.
- > Silla con estructura 5 radios en aluminio, giratoria, con ruedas, carcasa en polipropileno. Altura asiento regulable.



## 558M-DR

- > Sedia con seduta in polipropilene, imbottita. Telaio a 5 razze in alluminio, girevole, su ruote.
- > Swivel chair with 5 ways on castors, aluminium frame. Upholstered polypropylene shell.
- > Chaise pivotant avec châssis en aluminium 5 branches avec roulettes. Coque en polypropylène rembourrée.
- > Stuhl mit Sitzfläche aus Polypropylen und Bezug aus Stoff. Aluminium Gestell mit 5-armigem Fusskreuz und Rollen.
- > Silla con estructura 5 radios en aluminio, giratoria, con ruedas, carcasa en polipropileno tapizada.



## 544

- > Sedia con telaio da mensa in tubo acciaio e seduta in polipropilene.
- > Chair with "C" steel frame and polypropylene shell.
- > Chaise avec châssis en acier appui sur table et coque en polypropylène.
- > Stuhl mit Gestell mit vorderem, offenem Fußbügel und Sitzfläche aus Polypropylen.
- > Silla con estructura de comedor en acero. Carcasa en polipropileno.



## 565

- > Sedia con telaio da mensa in tubo acciaio. Seduta in polipropilene.
- > Chair with "C" steel frame and polypropylene shell.
- > Chaise avec châssis en acier appui sur table et coque en polypropylène.
- > Stuhl mit Gestell mit vorderem, offenem Fußbügel und Sitzfläche aus Polypropylen.
- > Silla con estructura de comedor en acero. Carcasa en polipropileno.



## 536

- > Carrello per 10 Uni 550 / 14 Uni 552
- > Trolley for 10 Uni 550 / 14 Uni 552
- > Chariot pour 10 Uni 550 / 14 Uni 552
- > Transportwagen für 10 Uni 550 / 14 Uni 552
- > Carrito por 10 Uni 550 / 14 Uni 552

## LE

- > Finiture telaio
- > Frame finishes
- > Finitions piètement
- > Gestell Fertigungen
- > Acabados estructura

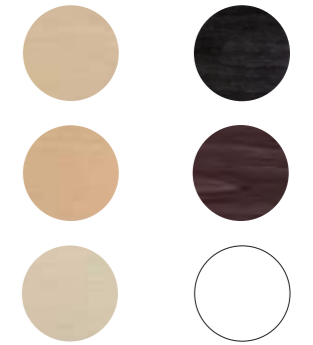

## TE

- > Finiture seduta (vedi p. 375)
- > Seat finishes (see p. 375)
- > Finitions de l'assise (voir p. 375)
- > Sitzfertigungen (sehen S. 375)
- > Acabados asiento (ver p. 375)

## AC

- > Finiture telaio (vedi p. 397)
- > Frame finishes (see p. 397)
- > Finitions piètement (voir p. 397)
- > Gestell Fertigungen (sehen S. 397)
- > Acabados estructura (ver p. 397)

## PP

- > Finiture seduta
- > Seat finishes
- > Finitions de l'assise
- > Sitzfertigungen
- > Acabados asiento

## AL PSH

- > Finiture telaio (vedi p. 399)
- > Frame finishes (see p. 399)
- > Finitions piètement (voir p. 399)
- > Gestell Fertigungen (sehen S. 399)
- > Acabados estructura (ver p. 399)

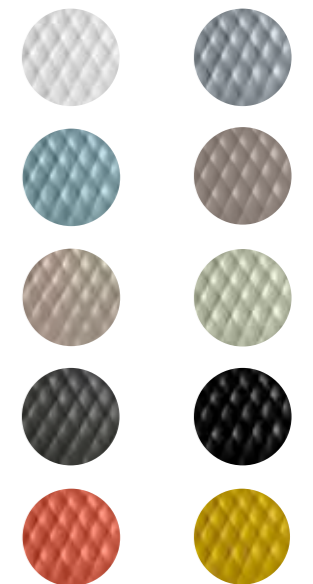

## AL VR

- > Finiture telaio
- > Frame finishes
- > Finitions piètement
- > Gestell Fertigungen
- > Acabados estructura

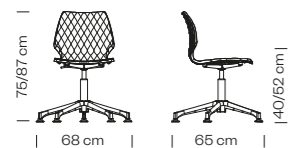

Peso / Weight / Poids / Gewicht / Peso **6,9 kg**

Imballo / Packaging / Emballage / Verpackung / Embalaje **0,50 m³**

Pezzi per scatola / Pieces per box / Pièces par carton / Stücke in einem Karton / Piezas por caja **2**



Peso / Weight / Poids / Gewicht / Peso **8,8 kg**

Imballo / Packaging / Emballage / Verpackung / Embalaje **0,39 m³**

Pezzi per scatola / Pieces per box / Pièces par carton / Stücke in einem Karton / Piezas por caja **1**

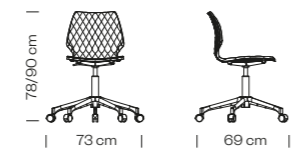

Peso / Weight / Poids / Gewicht / Peso **7 kg**

Imballo / Packaging / Emballage / Verpackung / Embalaje **0,50 m³**

Pezzi per scatola / Pieces per box / Pièces par carton / Stücke in einem Karton / Piezas por caja **2**



Peso / Weight / Poids / Gewicht / Peso **8,8 kg**

Imballo / Packaging / Emballage / Verpackung / Embalaje **0,39 m³**

Pezzi per scatola / Pieces per box / Pièces par carton / Stücke in einem Karton / Piezas por caja **1**

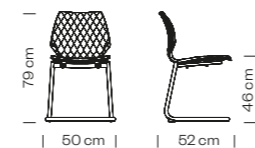

Peso / Weight / Poids / Gewicht / Peso **6,1 kg**

Imballo / Packaging / Emballage / Verpackung / Embalaje **0,35 m³**

Pezzi per scatola / Pieces per box / Pièces par carton / Stücke in einem Karton / Piezas por caja **4**

Impilabile / Stackable / Empilable / Stapelbar / Apilable **4**



Peso / Weight / Poids / Gewicht / Peso **5,2 kg**

Imballo / Packaging / Emballage / Verpackung / Embalaje **0,28 m³**

Pezzi per scatola / Pieces per box / Pièces par carton / Stücke in einem Karton / Piezas por caja **2**



# abaco+

design  
rdm

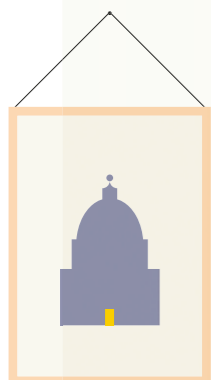

## 812

- > Sistema sedute multiple. Sedile e schienale imbottiti. Telaio in tubo acciaio. Modulo lineare L 60 cm.
- > Modular seating system. Upholstered seat and back. Steel frame. Linear module L 60 cm.
- > Système d'assises multiples. Assise et dossier rembourrés. Châssis en acier. Element linéaire de 60 cm.
- > System aus mehreren Sitzmöbeln. Gepolsterte Sitzfläche und Rückenlehne. Gestell aus Stahlrohren. Lineares Modul mit einer Länge von 60 cm.
- > Sistema de asientos múltiples. Asiento y respaldo tapizados. Estructura tubular en acero. Módulo lineal L 60 cm.

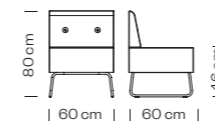

Peso / Weight / Poids / Gewicht / Peso **19 kg**

Imballo / Packaging / Emballage / Verpackung / Embalaje **0,34 m³**

Pezzi per scatola / Pieces per box / Pièces par carton / Stücke in einem Karton / Piezas por caja **1**



## 813

- > Sistema sedute multiple. Sedile e schienale imbottiti. Telaio in tubo acciaio. Modulo lineare L 120 cm.
- > Modular seating system. Upholstered seat and back. Steel frame. Linear module L 120 cm.
- > Système d'assises multiples. Assise et dossier rembourrés. Châssis en acier. Element linéaire de 120 cm.
- > System aus mehreren Sitzmöbeln. Gepolsterte Sitzfläche und Rückenlehne. Gestell aus Stahlrohren. Lineares Modul mit einer Länge von 120 cm.
- > Sistema de asientos múltiples. Asiento y respaldo tapizados. Estructura tubular en acero. Módulo lineal L 120 cm.



Peso / Weight / Poids / Gewicht / Peso **43 kg**

Imballo / Packaging / Emballage / Verpackung / Embalaje **0,66 m³**

Pezzi per scatola / Pieces per box / Pièces par carton / Stücke in einem Karton / Piezas por caja **1**



## 814

- > Sistema sedute multiple. Sedile e schienale imbottiti. Telaio in tubo acciaio. Modulo angolare.
- > Modular seating system. Upholstered seat and back. Steel frame. Corner module.
- > Système d'assises multiples. Assise et dossier rembourrés. Châssis en acier. Element d'angle.
- > System aus mehreren Sitzmöbeln. Gepolsterte Sitzfläche und Rückenlehne. Gestell aus Stahlrohren. Eckmodul.
- > Sistema de asientos múltiples. Asiento y respaldo tapizados. Estructura tubular en acero. Módulo de esquina.

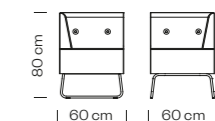

Peso / Weight / Poids / Gewicht / Peso **23 kg**

Imballo / Packaging / Emballage / Verpackung / Embalaje **0,34 m³**

Pezzi per scatola / Pieces per box / Pièces par carton / Stücke in einem Karton / Piezas por caja **1**



## 815

- > Sistema sedute multiple.  
Sedile imbottito. Telaio in tubo acciaio. Modulo pouf L 60 cm.
- > Modular seating system.  
Upholstered bench. Steel frame. Module L 60 cm.
- > Système d'assises multiples.  
Assise rembourrée. Châssis en acier. Element pouf de 60 cm.
- > System aus mehreren Sitzmöbeln.  
Gepolsterte Sitzfläche. Gestell aus Stahlrohren. Poufmodul mit einer Länge von 60 cm.
- > Sistema de asientos múltiples.  
Asiento tapizado. Estructura tubular en acero. Módulo pouf L 60 cm.

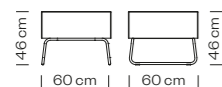

Peso / Weight / Poids / Gewicht / Peso **14 kg**

Imballo / Packaging / Emballage / Verpackung / Embalaje **0,28 m³**

Pezzi per scatola / Pieces per box / Pièces par carton / Stücke in einem Karton / Piezas por caja **1**



## 816

- > Sistema sedute multiple.  
Sedile imbottito. Telaio in tubo acciaio. Modulo pouf L 120 cm.
- > Modular seating system.  
Upholstered seat and back. Steel frame. Pouf module L 120 cm.
- > Système d'assises multiples.  
Assise rembourrée. Châssis en acier. Element pouf de 120 cm.
- > System aus mehreren Sitzmöbeln.  
Gepolsterte Sitzfläche. Gestell aus Stahlrohren. Poufmodul mit einer Länge von 120 cm.
- > Sistema de asientos múltiples.  
Asiento tapizado. Estructura tubular en acero. Módulo pouf L 120 cm.

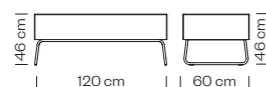

Peso / Weight / Poids / Gewicht / Peso **33 kg**

Imballo / Packaging / Emballage / Verpackung / Embalaje **0,40 m³**

Pezzi per scatola / Pieces per box / Pièces par carton / Stücke in einem Karton / Piezas por caja **1**

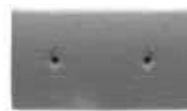

## 817

- > Sistema sedute multiple.  
Rivestimento a parete in tessuto. Modulo lineare L 60 cm.
- > Modular seating system.  
Upholstered wall panel. Module L 60 cm.
- > Système d'assises multiples.  
Revêtement mural en tissu. Element lineaire de 60 cm.
- > System aus mehreren Sitzmöbeln.  
Gepolsterte Wandverkleidung. Lineares Modul mit Länge von 60 cm.
- > Sistema de asientos múltiples.  
Revestimiento mural en tejido. Módulo lineal L 60 cm.

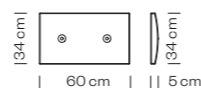

Peso / Weight / Poids / Gewicht / Peso **2 kg**

Imballo / Packaging / Emballage / Verpackung / Embalaje **0,18 m³**

Pezzi per scatola / Pieces per box / Pièces par carton / Stücke in einem Karton / Piezas por caja **4**



## 818

- > Sistema sedute multiple.  
Rivestimento a parete in tessuto. Modulo lineare L 120 cm.
- > Modular seating system.  
Upholstered wall panel. Module L 120 cm.
- > Système d'assises multiples.  
Revêtement mural en tissu. Element lineaire de 120 cm.
- > System aus mehreren Sitzmöbeln.  
Gepolsterte Wandverkleidung. Lineares Modul mit Länge von 120 cm.
- > Sistema de asientos múltiples.  
Revestimiento mural en tejido. Módulo lineal L 120 cm.



Peso / Weight / Poids / Gewicht / Peso **4 kg**

Imballo / Packaging / Emballage / Verpackung / Embalaje **0,18 m³**

Pezzi per scatola / Pieces per box / Pièces par carton / Stücke in einem Karton / Piezas por caja **4**



## 819

- > Sistema sedute multiple.  
Rivestimento a parete in tessuto. Modulo angolare (2 pezzi).
- > Modular seating system.  
Upholstered wall panel. Corner module (2 pieces).
- > Système d'assises multiples.  
Revêtement mural en tissu. Element d'angle (2 pièces).
- > System aus mehreren Sitzmöbeln.  
Gepolsterte Wandverkleidung. Eckmodul (2 Stücke).
- > Sistema de asientos múltiples.  
Revestimiento mural en tejido. Módulo de esquina (2 piezas).

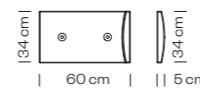

Peso / Weight / Poids / Gewicht / Peso **4 kg**

Imballo / Packaging / Emballage / Verpackung / Embalaje **0,18 m³**

Pezzi per scatola / Pieces per box / Pièces par carton / Stücke in einem Karton / Piezas por caja **2**

## TE

- > Finiture seduta (vedi p. 375)
- > Seat finishes (see p. 375)
- > Finitions de l'assise (voir p. 375)
- > Sitzfertigungen (sehen S. 375)
- > Acabados asiento (ver p. 375)



### Accessori / Accessories / Accessoires / Zubehoer / Accesorios

- > Cuscini cilindrici
- > Tubular cushions
- > Zylindrische Kissen
- > Cojines cilindricos

## AC

- > Finiture telaio (vedi p. 397)
- > Frame finishes (see p. 397)
- > Finitions piètement (voir p. 397)
- > Gestell Fertigungen (sehen S. 397)
- > Acabados estructura (ver p. 397)



# playa

design  
Carlo Bimbi Design







# 203

- > Sistema sedute multiple. Seduta lineare in polietilene stampato in rotazionale. Modulo lineare.
- > Modular seating system, rotational moulding polyethylene. Linear module.
- > Banquettes multiples. Canapé en polyéthylène roto-moulé. Module lineaire.
- > System aus mehreren Sitzmöbeln. Lineares Modul aus rotationsgeformtem Polyäthylen.
- > Sistema de asientos múltiples en polietileno moldeado rotativo. Módulo lineal con respaldo.



# 203C

- > Cuscino opzionale in tessuto per esterno (da rimuovere in caso di pioggia). Modulo lineare.
- > Optional cushion for outdoor use (to be removed in case of bad weather). Linear module.
- > Coussin optionel rembourré en tissu à l'eau pour usage extérieur, pour canapé (à rentrer en cas de intempéries). Module lineaire.
- > Optionales Außengewebekissen (im Falle von Regen zu entfernen). Lineares Modul.
- > Cojín opcional en tejido para exteriores (por removerse en caso de lluvia). Módulo lineal.



# 204

- > Sistema sedute multiple. Seduta angolare in polietilene stampato in rotazionale. Modulo angolare.
- > Modular seating system, rotational moulding polyethylene. Corner module.
- > Banquettes multiples. Canapé en polyéthylène roto-moulé. Module d'angle.
- > System aus mehreren Sitzmöbeln. Eckiges Modul aus rotationsgeformtem Polyäthylen.
- > Sistema de asientos múltiples en polietileno moldeado rotativo. Módulo de esquina con respaldo.



# 204C

- > Cuscino opzionale in tessuto per esterno (da rimuovere in caso di pioggia). Modulo angolare.
- > Optional cushion for outdoor use (to be removed in case of bad weather). Corner module.
- > Coussin optionel rembourré en tissu à l'eau pour usage extérieur, pour canapé (à rentrer en cas de intempéries). Module d'angle.
- > Optionales Außengewebekissen (im Falle von Regen zu entfernen). Eckiges Modul.
- > Cojín opcional en tejido para exteriores (por removerse en caso de lluvia). Módulo de esquina.



# 205

- > Sistema sedute multiple. Pouf in polietilene stampato in rotazionale. Modulo pouf.
- > Multiple seating system, rotational moulding polyethylene. Pouf module.
- > Banquettes multiples. Pouf en polyéthylène roto-moulé.
- > System aus mehreren Sitzmöbeln. Hocker aus rotationsgeformtem Polyäthylen.
- > Sistema de asientos múltiples en polietileno moldeado rotativo. Módulo pouf.



# PE

- > Finiture seduta
- > Seat finishes
- > Finitions de l'assise
- > Sitzfertigungen
- > Acabados asiento

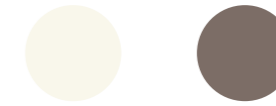

# TE

- > Finiture seduta (vedi p. 375)
- > Seat finishes (see p. 375)
- > Finitions de l'assise (voir p. 375)
- > Sitzfertigungen (sehen S. 375)
- > Acabados asiento (ver p. 375)

solo / only / seulement /  
nur / solamente  
**Reviva** p. 388  
**In&Out** p. 384  
**Fabthirty** p. 389

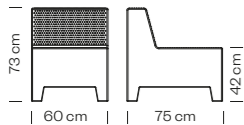

Peso / Weight /  
Poids / Gewicht / Peso **9 kg**

Imballo / Packaging /  
Emballage / Verpackung /  
Embalaje **0,58 m³**

Pezzi per scatola /  
Pieces per box /  
Pièces par carton /  
Stücke in einem Karton /  
Piezas por caja **2**

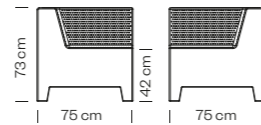

Peso / Weight /  
Poids / Gewicht / Peso **12 kg**

Imballo / Packaging /  
Emballage / Verpackung /  
Embalaje **0,47 m³**

Pezzi per scatola /  
Pieces per box /  
Pièces par carton /  
Stücke in einem Karton /  
Piezas por caja **1**

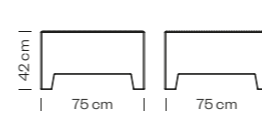

Peso / Weight /  
Poids / Gewicht / Peso **8,6 kg**

Imballo / Packaging /  
Emballage / Verpackung /  
Embalaje **0,28 m³**

Pezzi per scatola /  
Pieces per box /  
Pièces par carton /  
Stücke in einem Karton /  
Piezas por caja **2**



zero

design  
Carlo Bimbi Design

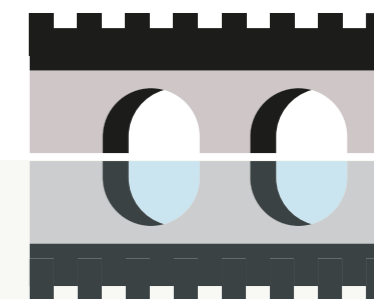
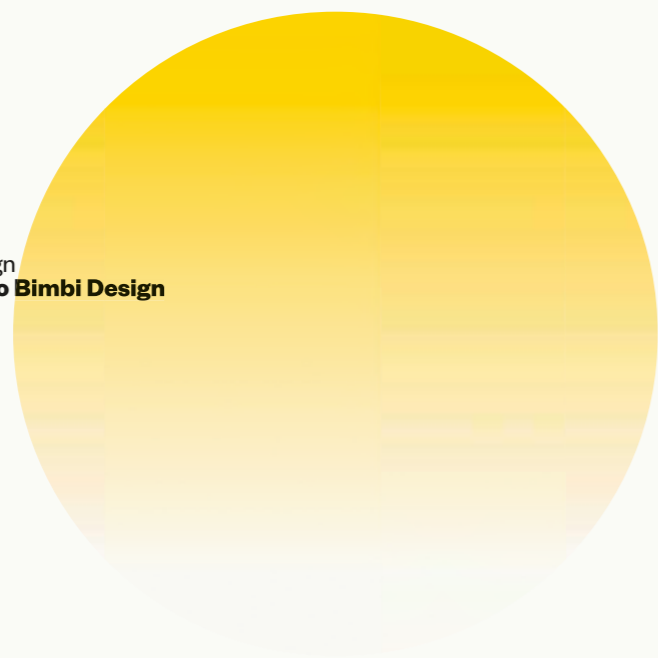



208

- > Sistema sedute multiple in tubo acciaio con trattamento cataforesi. Tessuto per esterno. Modulo lineare.
- > Modular sofa system with painted steel frame and cataphoresis-treatment. Fabric for outdoors. Linear module.
- > Banquettes multiples, châssis en tube d'acier traité en cataphorèse. Coussin en tissu. Module linéaire.
- > System aus mehreren Sitzmöbeln aus Stahlrohren mit Kataphorese. Gewebe für den Außenbereich. Lineares Modul.
- > Sistema de asientos múltiples con estructura tubular en acero con tratamiento de cataforesis. Asiento y respaldo tapizados con tejido para exteriores. Módulo lineal.

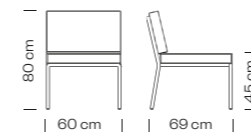

Peso / Weight / Poids / Gewicht / Peso **7,6 kg**

Imballo / Packaging / Emballage / Verpackung / Embalaje **0,50 m³**

Pezzi per scatola / Pieces per box / Pièces par carton / Stücke in einem Karton / Piezas por caja **2**

Impilabile / Stackable / Empilable / Stapelbar / Apilable **4\***



209

- > Sistema sedute multiple in tubo acciaio con trattamento cataforesi. Tessuto per esterno. Modulo angolare.
- > Modular sofa system with painted steel frame and cataphoresis-treatment. Fabric for outdoors. Corner module.
- > Banquettes multiples, châssis en tube d'acier traité en cataphorèse. Coussin en tissu. Module d'angle.
- > System aus mehreren Sitzmöbeln aus Stahlrohren mit Kataphorese. Gewebe für den Außenbereich. Eckiges Modul.
- > Sistema de asientos múltiples con estructura tubular en acero con tratamiento de cataforesis. Asiento y respaldo tapizados con tejido para exteriores. Módulo de esquina.

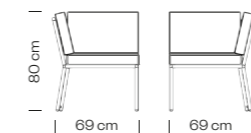

Peso / Weight / Poids / Gewicht / Peso **10,2 kg**

Imballo / Packaging / Emballage / Verpackung / Embalaje **0,45 m³**

Pezzi per scatola / Pieces per box / Pièces par carton / Stücke in einem Karton / Piezas por caja **2**

Impilabile / Stackable / Empilable / Stapelbar / Apilable **2\***

TE

- > Finiture seduta
- > Seat finishes
- > Finitions de l'assise
- > Sitzfertigungen
- > Acabados asiento

solo / only / seulement / nur / solamente  
**Reviva** p. 388  
**In&Out** p. 384  
**Fabthirty** p. 389

AC

- > Finiture telaio (vedi p. 397)
- > Frame finishes (see p. 397)
- > Finitions piètement (voir p. 397)
- > Gestell Fertigungen (sehen S. 397)
- > Acabados estructura (ver p. 397)

\* Impilabile con cuscino smontato / Stackable without cushion / Empilable sans coussin / Stapelfähigkeit ohne Kissen / Apilable sin cojín



# marka

design  
**Carlo Bimbi Design**

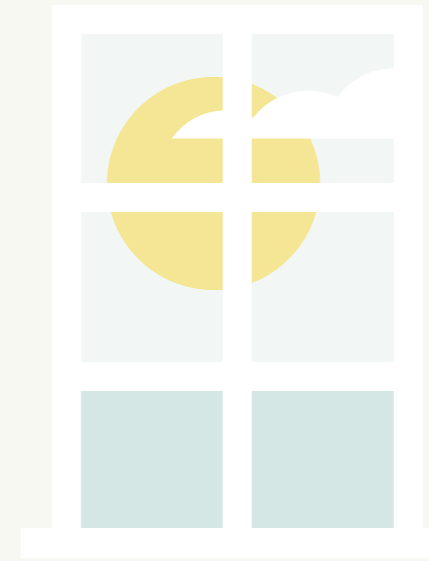



## 566

- > Poltroncina con telaio a 4 gambe in acciaio. Sedile e schienale in tessuto.
- > Armchair with 4 legs steel frame. Upholstered seat and back.
- > Fauteuil avec châssis 4 pieds en acier. Assise et dossier en tissu.
- > Armlehnstuhl mit 4-beinigem Stahlgestell. Gepolsterte Sitzfläche und Rückenlehne.
- > Sillón con estructura tubular 4 patas en acero. Asiento y respaldo tapizados.



## 567

- > Poltroncina con telaio a basamento centrale girevole in acciaio. Sedile e schienale in tessuto.
- > Swivel armchair with central steel base. Upholstered seat and back.
- > Fauteuil pivotant avec piétement central en acier. Assise et dossier en tissu.
- > Armlehnstuhl mit Gestell auf zentralem, drehbarem Standfuss aus Stahl. Gepolsterte Sitzfläche und Rückenlehne.
- > Sillón con estructura columna central en acero, giratoria. Asiento y respaldo tapizados.



## 568

- > Poltroncina con telaio a 4 razze in tubo acciaio. Sedile e schienale in tessuto.
- > Armchair with 4 ways steel frame. Upholstered seat and back.
- > Fauteuil avec châssis 4 branches en acier. Assise et dossier en tissu.
- > Armlehnstuhl mit 4-beinigem Stahlgestell. Gepolsterte Sitzfläche und Rückenlehne.
- > Sillón con estructura 4 radios en acero. Asiento y respaldo tapizados.



## 569-DP

- > Poltroncina con telaio in alluminio a 5 razze, girevole, su ruote. Sedile e schienale in tessuto. Regolabile in altezza.
- > Swivel armchair with 5 ways aluminium frame. Upholstered seat and back. Adjustable seat height.
- > Fauteuil pivotant avec châssis en aluminium 5 branches avec patins. Assise et dossier en tissu. Réglable en hauteur.
- > Armlehnstuhl mit Aluminiumgestell, drehbar und mit 5-armigem Fusskreuz. Gepolsterte Sitzfläche und Rückenlehne. Höhenverstellbar.
- > Sillón con estructura 5 radios en aluminio, giratoria. Asiento y respaldo tapizados. Altura asiento regulable.



## 569-DR

- > Poltroncina con telaio in alluminio a 5 razze, girevole, su ruote. Sedile e schienale in tessuto. Regolabile in altezza.
- > Swivel armchair with 5 ways on castors, aluminium frame. Adjustable seat height. Upholstered seat and back.
- > Fauteuil pivotant avec châssis en aluminium 5 branches avec roulettes. Assise et dossier en tissu. Réglable en hauteur.
- > Armlehnstuhl mit Aluminiumgestell, drehbar und mit 5-armigem Fusskreuz und Rollen. Gepolsterte Sitzfläche und Rückenlehne. Höhenverstellbar.
- > Sillón con estructura 5 radios en aluminio, giratoria, con ruedas. Asiento y respaldo tapizados. Altura asiento regulable.



## 570

- > Poltroncina con telaio a 4 gambe in faggio. Sedile e schienale in tessuto.
- > Armchair with beech wood frame, 4 legs. Upholstered seat and back.
- > Fauteuil avec châssis 4 pieds en hêtre. Assise et dossier en tissu.
- > Armlehnstuhl mit 4-beinigem Buchenholzgestell. Gepolsterte Sitzfläche und Rückenlehne.
- > Sillón con estructura 4 patas en madera de haya. Asiento y respaldo tapizados.

## TE

- > Finiture seduta (vedi p. 375)
- > Seat finishes (see p. 375)
- > Finitions de l'assise (voir p. 375)
- > Sitzfertigungen (sehen S. 375)
- > Acabados asiento (ver p. 375)

## AC

- > Finiture telaio (vedi p. 397)
- > Frame finishes (see p. 397)
- > Finitions piètement (voir p. 397)
- > Gestell Fertigungen (sehen S. 397)
- > Acabados estructura (ver p. 397)

## AL PSH

- > Finiture telaio (vedi p. 399)
- > Frame finishes (see p. 399)
- > Finitions piètement (voir p. 399)
- > Gestell Fertigungen (sehen S. 399)
- > Acabados estructura (ver p. 399)

## LE

- > Finiture telaio
- > Frame finishes
- > Finitions piètement
- > Gestell Fertigungen
- > Acabados estructura



## AL VR

- > Finiture telaio
- > Frame finishes
- > Finitions piètement
- > Gestell Fertigungen
- > Acabados estructura

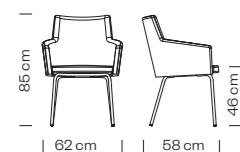

Peso / Weight / Poids / Gewicht / Peso **10 kg**

Imballo / Packaging / Emballage / Verpackung / Embalaje **0,34 m³**

Pezzi per scatola / Pieces per box / Pièces par carton / Stücke in einem Karton / Piezas por caja **1**

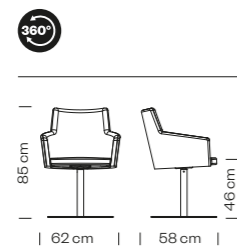

Peso / Weight / Poids / Gewicht / Peso **21 kg**

Imballo / Packaging / Emballage / Verpackung / Embalaje **0,34 m³**

Pezzi per scatola / Pieces per box / Pièces par carton / Stücke in einem Karton / Piezas por caja **1**

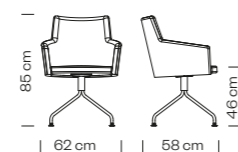

Peso / Weight / Poids / Gewicht / Peso **10 kg**

Imballo / Packaging / Emballage / Verpackung / Embalaje **0,34 m³**

Pezzi per scatola / Pieces per box / Pièces par carton / Stücke in einem Karton / Piezas por caja **1**



Peso / Weight / Poids / Gewicht / Peso **12 kg**

Imballo / Packaging / Emballage / Verpackung / Embalaje **0,50 m³**

Pezzi per scatola / Pieces per box / Pièces par carton / Stücke in einem Karton / Piezas por caja **1**



Peso / Weight / Poids / Gewicht / Peso **12 kg**

Imballo / Packaging / Emballage / Verpackung / Embalaje **0,50 m³**

Pezzi per scatola / Pieces per box / Pièces par carton / Stücke in einem Karton / Piezas por caja **1**



Peso / Weight / Poids / Gewicht / Peso **10,4 kg**

Imballo / Packaging / Emballage / Verpackung / Embalaje **0,34 m³**

Pezzi per scatola / Pieces per box / Pièces par carton / Stücke in einem Karton / Piezas por caja **1**

# agatha

design  
rdm

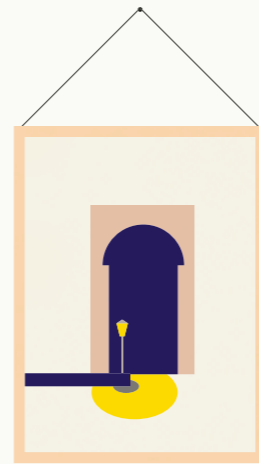

## 047

- > Poltroncina con telaio a 4 gambe in tubo acciaio. Sedile e schienale in tessuto.
- > Armchair with 4 legs steel frame. Upholstered seat and back.
- > Fauteuil avec châssis 4 pieds en acier. Assise et dossier en tissu.
- > Armlehnstuhl mit 4-beinigem Stahlgestell. Gepolsterte Sitzfläche und Rückenlehne.
- > Sillón con estructura tubular 4 patas en acero. Asiento y respaldo tapizados.

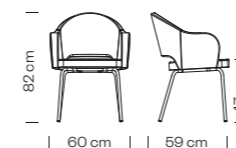

Peso / Weight / Poids / Gewicht / Peso **9,3 kg**

Imballo / Packaging / Emballage / Verpackung / Embalaje **0,34 m³**

Pezzi per scatola / Pieces per box / Pièces par carton / Stücke in einem Karton / Piezas por caja **1**



## 048

- > Poltroncina con telaio a 4 razze in tubo acciaio. Sedile e schienale in tessuto.
- > Armchair with 4 ways steel frame. Upholstered seat and back.
- > Fauteuil avec châssis 4 branches en acier. Assise et dossier en tissu.
- > Armlehnstuhl mit 4-armigem Fusskreuz aus Stahl. Gepolsterte Sitzfläche und Rückenlehne.
- > Sillón con estructura tubular 4 radios en acero. Asiento y respaldo tapizados.

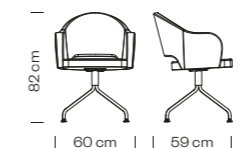

Peso / Weight / Poids / Gewicht / Peso **9,8 kg**

Imballo / Packaging / Emballage / Verpackung / Embalaje **0,34 m³**

Pezzi per scatola / Pieces per box / Pièces par carton / Stücke in einem Karton / Piezas por caja **1**



## 572

- > Poltroncina con telaio a 4 gambe in faggio. Sedile e schienale in tessuto.
- > Armchair with beech wood frame. 4 legs. Upholstered seat and back.
- > Fauteuil avec châssis 4 pieds en hêtre. Assise et dossier en tissu.
- > Armlehnstuhl mit 4-beinigem Buchenholzgestell. Gepolsterte Sitzfläche und Rückenlehne.
- > Sillón con estructura 4 patas en madera de haya. Asiento y respaldo tapizados.

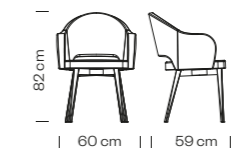

Peso / Weight / Poids / Gewicht / Peso **9,7 kg**

Imballo / Packaging / Emballage / Verpackung / Embalaje **0,34 m³**

Pezzi per scatola / Pieces per box / Pièces par carton / Stücke in einem Karton / Piezas por caja **1**



## 046-DP

- > Poltroncina con telaio in alluminio a 5 razze, girevole. Sedile e schienale in tessuto.
- > Swivel armchair with 5 ways aluminium frame. Upholstered seat and back.
- > Fauteuil pivotant avec châssis en aluminium 5 branches avec patins. Assise et dossier en tissu.
- > Armlehnstuhl mit Aluminiumgestell, drehbar und mit 5-armigem Fusskreuz. Gepolsterte Sitzfläche und Rückenlehne.
- > Sillón con estructura 5 radios en aluminio, giratoria. Asiento y respaldo tapizados.



Peso / Weight / Poids / Gewicht / Peso **11,8 kg**

Imballo / Packaging / Emballage / Verpackung / Embalaje **0,50 m³**

Pezzi per scatola / Pieces per box / Pièces par carton / Stücke in einem Karton / Piezas por caja **1**





## 046-DR

- > Poltroncina con telaio in alluminio a 5 razze, girevole, su ruote. Sedile e schienale in tessuto.
- > Swivel armchair with 5 ways on castors, aluminium frame. Upholstered seat and back.
- > Fauteuil pivotant avec châssis en aluminium 5 branches avec roulettes. Assise et dossier en tissu.
- > Armlehnstuhl mit Aluminiumgestell, drehbar und mit 5-armigem Fusskreuz und Rollen. Gepolsterte Sitzfläche und Rückenlehne.
- > Sillón con estructura 5 radios en aluminio, giratoria, con ruedas. Asiento y respaldo tapizados.

360°

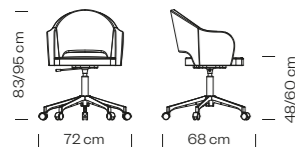

Peso / Weight / Poids / Gewicht / Peso **11,8 kg**

Imballo / Packaging / Emballage / Verpackung / Embalaje **0,50 m³**

Pezzi per scatola / Pieces per box / Pièces par carton / Stücke in einem Karton / Piezas por caja **1**



## 383

- > Sgabello con telaio a basamento centrale girevole in acciaio. Sedile e schienale in tessuto.
- > Swivel stool with central steel base frame. Upholstered seat and back.
- > Tabouret pivotant avec piétement central en acier. Assise et dossier en tissu.
- > Barhocker mit Gestell auf zentralem, drehbarem Standfuss aus Stahl. Gepolsterte Sitzfläche und Rückenlehne.
- > Taburete con estructura columna central en acero, giratoria. Asiento y respaldo tapizados.

360°

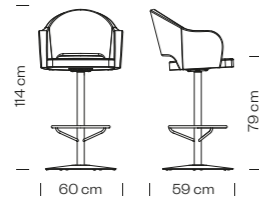

Peso / Weight / Poids / Gewicht / Peso **21,5 kg**

Imballo / Packaging / Emballage / Verpackung / Embalaje **0,44 m³**

Pezzi per scatola / Pieces per box / Pièces par carton / Stücke in einem Karton / Piezas por caja **1**



## 384

- > Sgabello con telaio a 4 gambe in tubo acciaio. Sedile e schienale in tessuto.
- > Barstool with 4 legs steel frame. Upholstered seat and back.
- > Tabouret avec châssis 4 pieds en acier. Assise et dossier en tissu.
- > Barhocker mit 4-beinigem Stahlgestell. Gepolsterte Sitzfläche und Rückenlehne.
- > Taburete con estructura tubular 4 patas en acero. Asiento y respaldo tapizados.

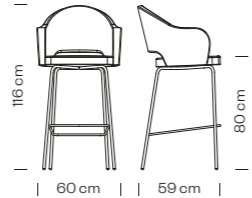

Peso / Weight / Poids / Gewicht / Peso **9,6 kg**

Imballo / Packaging / Emballage / Verpackung / Embalaje **0,44 m³**

Pezzi per scatola / Pieces per box / Pièces par carton / Stücke in einem Karton / Piezas por caja **1**

## TE

- > Finiture seduta (vedi p. 379)
- > Seat finishes (see p. 379)
- > Finitions de l'assise (voir p. 379)
- > Sitzfertigungen (sehen S. 379)
- > Acabados asiento (ver p. 379)

## AC

- > Finiture telaio (vedi p. 397)
- > Frame finishes (see p. 397)
- > Finitions piètement (voir p. 397)
- > Gestell Fertigungen (sehen S. 397)
- > Acabados estructura (ver p. 397)

## AL PSH

- > Finiture telaio (vedi p. 399)
- > Frame finishes (see p. 399)
- > Finitions piètement (voir p. 399)
- > Gestell Fertigungen (sehen S. 399)
- > Acabados estructura (ver p. 399)

## LE

- > Finiture telaio
- > Frame finishes
- > Finitions piètement
- > Gestell Fertigungen
- > Acabados estructura



## AL VR

- > Finiture telaio
- > Frame finishes
- > Finitions piètement
- > Gestell Fertigungen
- > Acabados estructura

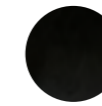

# duo

design  
Franco Bertoli & Max Pajetta

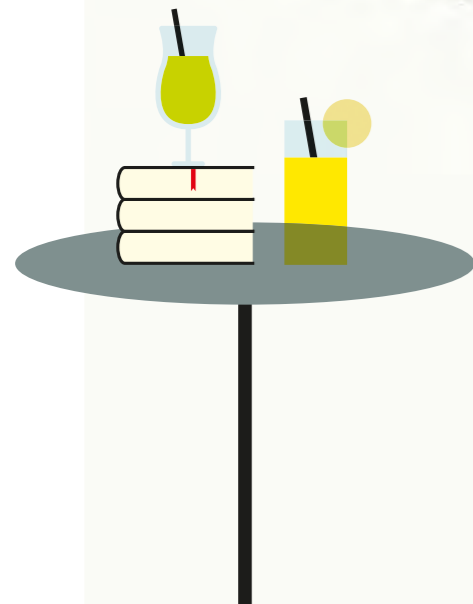

## 140

- > Sedia con telaio a slitta in tondino acciaio. Sedile e schienale in faggio e/o tessuto.
- > Chair with sled steel frame, beech wood and/or upholstered seat and back.
- > Chaise avec châssis en fil d'acier, pied luge, assise et dossier en bois ou en tissu.
- > Stuhl mit Kufengestell aus Stahl. Sitzfläche und Rückenlehne aus Buchenholz und/oder mit Bezug aus Stoff.
- > Silla con estructura patin en acero. Asiento y respaldo en madera de haya y/o tapizados.

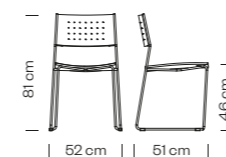

Peso / Weight / Poids / Gewicht / Peso **6,6 kg**

Imballo / Packaging / Emballage / Verpackung / Embalaje **0,33 m<sup>3</sup>**

Pezzi per scatola / Pieces per box / Pièces par carton / Stücke in einem Karton / Piezas por caja **4**

Impilabile / Stackable / Empilable / Stapelbar / Apilable **4**

## 140-G

- > Sedia con telaio a slitta in tondino acciaio e sistema aggancio. Sedile e schienale in legno e/o tessuto.
- > Chair with sled steel frame with linking device, beech wood and/or upholstered seat and back.
- > Chaise avec châssis luge en fil d'acier et système d'accrochage, assise et dossier en bois ou en tissu.
- > Stuhl mit Kufengestell aus Stahl und Verbindungssystem. Sitzfläche und Rückenlehne aus Buchenholz und/oder mit Bezug aus Stoff.
- > Silla con estructura patin en acero y sistema de enganche. Asiento y respaldo en madera de haya y/o tapizados.

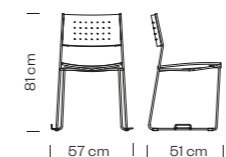

Peso / Weight / Poids / Gewicht / Peso **6,7 kg**

Imballo / Packaging / Emballage / Verpackung / Embalaje **0,33 m<sup>3</sup>**

Pezzi per scatola / Pieces per box / Pièces par carton / Stücke in einem Karton / Piezas por caja **4**

Impilabile / Stackable / Empilable / Stapelbar / Apilable **4**

Sistema di aggancio / Linking device / Système d'accrochage / Verbindungssystem / Sistema de enganche



## TE

- > Finiture seduta (vedi p. 375)
- > Seat finishes (see p. 375)
- > Finitions de l'assise (voir p. 375)
- > Sitzfertigungen (sehen S. 375)
- > Acabados asiento (ver p. 375)

## AC

- > Finiture telaio (vedi p. 397)
- > Frame finishes (see p.397)
- > Finitions piètement (voir p. 397)
- > Gestell Fertigungen (sehen S. 397)
- > Acabados estructura (ver p. 397)

## LE

- > Finiture seduta
- > Seat finishes
- > Finitions de l'assise
- > Sitzfertigungen
- > Acabados asiento

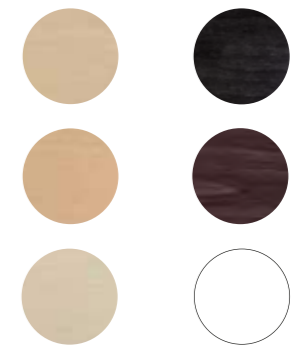

# punto

design  
**Francesco Geraci**

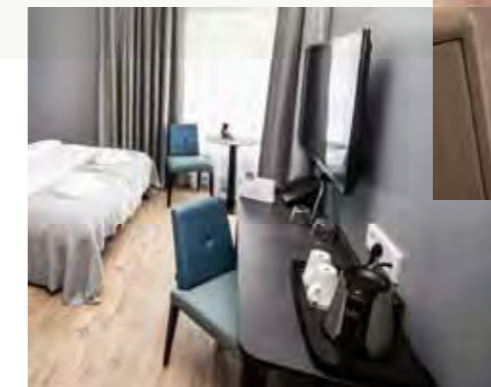
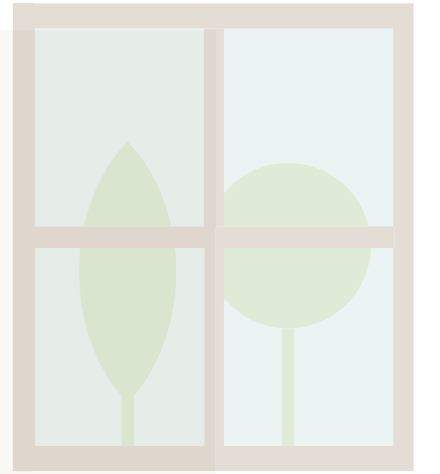
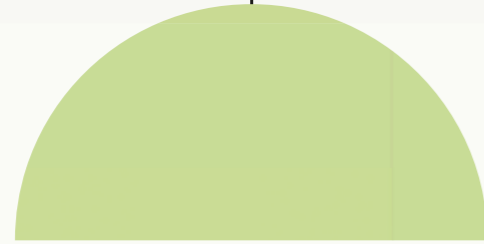





190

- > Sedia con telaio a 4 gambe in faggio. Sedile e schienale in tessuto.
- > Chair with beech wood frame, 4 legs. Upholstered seat and back.
- > Chaise avec châssis 4 pieds en hêtre, assise et dossier en tissu.
- > Stuhl mit 4-beinigem Buchenholzgestell. Gepolsterte Sitzfläche und Rückenlehne.
- > Silla con estructura 4 patas en madera de haya. Asiento y respaldo tapizados.



191

- > Poltroncina a 4 gambe in faggio. Sedile e schienale rivestiti.
- > Armchair with beech wood frame, 4 legs. Upholstered seat and back.
- > Fauteuil avec châssis 4 pieds en hêtre, assise et dossier en tissu.
- > Stuhl mit 4-beinigem Buchenholzgestell. Gepolsterte Sitzfläche, Rückenlehne und Armlehnen.
- > Sillon con estructura 4 patas en madera de haya. Asiento y respaldo tapizados.



390

- > Sgabello con telaio a 4 gambe in faggio. Sedile e schienale in tessuto.
- > Barstool with beech wood frame, 4 legs. Upholstered seat and back.
- > Tabouret avec châssis 4 pieds en hêtre, assise et dossier en tissu.
- > Barhocker mit 4-beinigem Buchenholzgestell. Gepolsterte Sitzfläche und Rückenlehne.
- > Taburete con estructura 4 patas en madera de haya. Asiento y respaldo tapizados.



227

- > Sistema sedute multiple. Seduta lineare con telaio a 4 gambe in faggio. Sedile e schienale in tessuto. Modulo lineare.
- > Modular seating system, linear seating with beech wood frame, 4 legs. Upholstered seat and back. Linear module.
- > Banquettes multiples. Canapé, avec assise et dossier rembourrés, revêtement en tissu, châssis en hêtre. Module linéaire.
- > System aus mehreren Sitzmöbeln. Lineares Modul mit 4-beinigem Buchenholzgestell. Gepolsterte Sitzfläche und Rückenlehne.
- > Sistema de asientos múltiples. Asiento y respaldo tapizados. Estructura 4 patas en madera de haya. Módulo lineal.



228

- > Sistema sedute multiple. Seduta angolare con telaio a 4 gambe in faggio. Sedile e schienale in tessuto. Modulo angolare.
- > Modular seating system, linear seating with beech wood frame, 4 legs. Upholstered seat and back. Angular module.
- > Banquettes multiples. Canapé, avec assise et dossier rembourrés, revêtement en tissu, châssis en hêtre. Module d'angle.
- > System aus mehreren Sitzmöbeln. Eckiges Modul mit 4-beinigem Buchenholzgestell. Gepolsterte Sitzfläche und Rückenlehne.
- > Sistema de asientos múltiples. Asiento y respaldo tapizados. Estructura 4 patas en madera de haya. Módulo de esquina.



229

- > Sistema sedute multiple. Pouf con telaio a 4 gambe in faggio. Sedile in tessuto. Modulo pouf.
- > Modular seating system, linear seating with beech wood frame, 4 legs. Upholstered seat. Pouf module.
- > Banquettes multiples. Pouf, avec assise rembourrée, revêtement en tissu, châssis en hêtre.
- > System aus mehreren Sitzmöbeln. Hocker Modul mit 4-beinigem Buchenholzgestell. Gepolsterte Sitzfläche.
- > Sistema de asientos múltiples. Asiento tapizados. Estructura 4 patas en madera de haya. Módulo pouf.

TE

- > Finiture seduta (vedi p. 375)
- > Seat finishes (see p. 375)
- > Finitions de l'assise (voir p. 375)
- > Sitzfertigungen (sehen S. 375)
- > Acabados asiento (ver p. 375)

LE

- > Finiture telaio
- > Frame finishes
- > Finitions piètement
- > Gestell Fertigungen
- > Acabados estructura

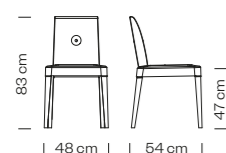
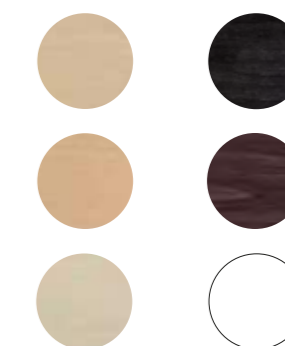

Peso / Weight / Poids / Gewicht / Peso **6 kg**

Imballo / Packaging / Emballage / Verpackung / Embalaje **0,39 m³**

Pezzi per scatola / Pieces per box / Pièces par carton / Stücke in einem Karton / Piezas por caja **2**

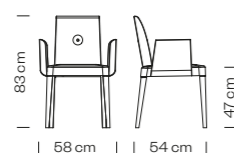

Peso / Weight / Poids / Gewicht / Peso **8 kg**

Imballo / Packaging / Emballage / Verpackung / Embalaje **0,34 m³**

Pezzi per scatola / Pieces per box / Pièces par carton / Stücke in einem Karton / Piezas por caja **1**

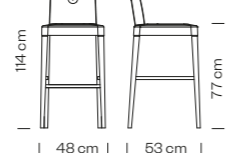

Peso / Weight / Poids / Gewicht / Peso **8 kg**

Imballo / Packaging / Emballage / Verpackung / Embalaje **0,35 m³**

Pezzi per scatola / Pieces per box / Pièces par carton / Stücke in einem Karton / Piezas por caja **1**

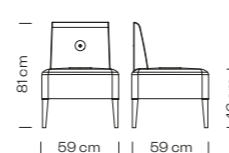

Peso / Weight / Poids / Gewicht / Peso **9 kg**

Imballo / Packaging / Emballage / Verpackung / Embalaje **0,34 m³**

Pezzi per scatola / Pieces per box / Pièces par carton / Stücke in einem Karton / Piezas por caja **1**

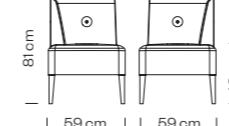

Peso / Weight / Poids / Gewicht / Peso **13 kg**

Imballo / Packaging / Emballage / Verpackung / Embalaje **0,34 m³**

Pezzi per scatola / Pieces per box / Pièces par carton / Stücke in einem Karton / Piezas por caja **1**

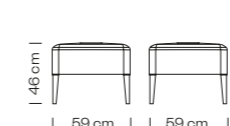

Peso / Weight / Poids / Gewicht / Peso **6 kg**

Imballo / Packaging / Emballage / Verpackung / Embalaje **0,34 m³**

Pezzi per scatola / Pieces per box / Pièces par carton / Stücke in einem Karton / Piezas por caja **2**

# abaco

design  
rdm

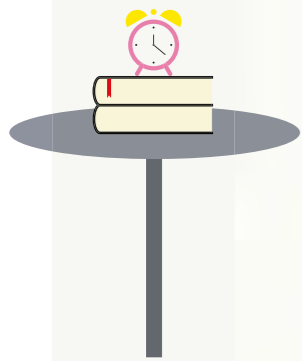



## 750

- > Sistema sedute multiple. Sedile e schienale imbottiti. Telaio in tubo acciaio. Modulo lineare L 60 cm.
- > Modular seating system. Upholstered seat and back. Steel frame. Linear module L 60 cm.
- > Système d'assises multiples. Assise et dossier rembourrés. Châssis en acier. Element linéaire de 60 cm.
- > System aus mehreren Sitzmöbeln. Gepolsterte Sitzfläche und Rückenlehne. Gestell aus Stahlrohren. Lineares Modul mit einer Länge von 60 cm.
- > Sistema de asientos múltiples. Asiento y respaldo tapizados. Estructura tubular en acero. Módulo lineal L 60 cm.

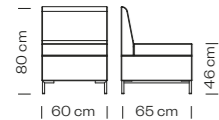

Peso / Weight / Poids / Gewicht / Peso **21 kg**

Imballo / Packaging / Emballage / Verpackung / Embalaje **0,35 m³**

Pezzi per scatola / Pieces per box / Pièces par carton / Stücke in einem Karton / Piezas por caja **1**

## 751

- > Sistema sedute multiple. Sedile e schienale imbottiti. Telaio in tubo acciaio. Modulo lineare L 120 cm.
- > Modular seating system. Upholstered seat and back. Steel frame. Linear module L 120 cm.
- > Système d'assises multiples. Assise et dossier rembourrés. Châssis en acier. Element linéaire de 120 cm.
- > System aus mehreren Sitzmöbeln. Gepolsterte Sitzfläche und Rückenlehne. Gestell aus Stahlrohren. Lineares Modul mit einer Länge von 120 cm.
- > Sistema de asientos múltiples. Asiento y respaldo tapizados. Estructura tubular en acero. Módulo lineal L 120 cm.

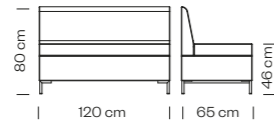

Peso / Weight / Poids / Gewicht / Peso **44 kg**

Imballo / Packaging / Emballage / Verpackung / Embalaje **0,73 m³**

Pezzi per scatola / Pieces per box / Pièces par carton / Stücke in einem Karton / Piezas por caja **1**

## 752

- > Sistema sedute multiple. Sedile e schienale imbottiti. Telaio in tubo acciaio. Modulo angolare.
- > Modular seating system. Upholstered seat and back. Steel frame. Corner module.
- > Système d'assises multiples. Assise et dossier rembourrés. Châssis en acier. Element d'angle.
- > System aus mehreren Sitzmöbeln. Gepolsterte Sitzfläche und Rückenlehne. Gestell aus Stahlrohren. Eckmodul.
- > Sistema de asientos múltiples. Asiento y respaldo tapizados. Estructura tubular en acero. Módulo de esquina.

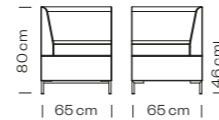

Peso / Weight / Poids / Gewicht / Peso **25 kg**

Imballo / Packaging / Emballage / Verpackung / Embalaje **0,38 m³**

Pezzi per scatola / Pieces per box / Pièces par carton / Stücke in einem Karton / Piezas por caja **1**

## 753

- > Sistema sedute multiple. Sedile imbottito. Telaio in tubo acciaio. Modulo pouf L 60 cm.
- > Modular seating system. Upholstered seat. Steel frame. Pouf module L 60 cm.
- > Système d'assises multiples. Assise rembourrée. Châssis en acier. Element pouf de 60 cm.
- > System aus mehreren Sitzmöbeln. Gepolsterte Sitzfläche. Gestell aus Stahlrohren. Hocker mit einer Länge von 60 cm.
- > Sistema de asientos múltiples. Asiento tapizado. Estructura tubular en acero. Módulo pouf L 60 cm.

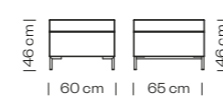

Peso / Weight / Poids / Gewicht / Peso **15 kg**

Imballo / Packaging / Emballage / Verpackung / Embalaje **0,28 m³**

Pezzi per scatola / Pieces per box / Pièces par carton / Stücke in einem Karton / Piezas por caja **1**

## 754

- > Sistema sedute multiple. Sedile imbottito. Telaio in tubo acciaio. Modulo pouf L 120 cm.
- > Modular seating system. Upholstered seat. Steel frame. Pouf module L 120 cm.
- > Système d'assises multiples. Assise rembourrée. Châssis en acier. Element pouf de 120 cm.
- > System aus mehreren Sitzmöbeln. Gepolsterte Sitzfläche. Gestell aus Stahlrohren. Hocker mit einer Länge von 120 cm.
- > Sistema de asientos múltiples. Asiento tapizado. Estructura tubular en acero. Módulo pouf L 120 cm.

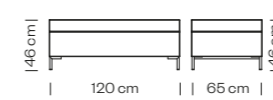

Peso / Weight / Poids / Gewicht / Peso **34 kg**

Imballo / Packaging / Emballage / Verpackung / Embalaje **0,45 m³**

Pezzi per scatola / Pieces per box / Pièces par carton / Stücke in einem Karton / Piezas por caja **1**

## 755

- > Sistema sedute multiple. Rivestimento a parete in tessuto. Modulo lineare L 60 cm.
- > Modular seating system. Upholstered wall panel. Linear module L 60 cm.
- > Système d'assises multiples. Revêtement mural en tissu. Element lineaire de 60 cm.
- > System aus mehreren Sitzmöbeln. Gepolsterte Wandverkleidung. Lineares Modul mit Länge von 60 cm.
- > Sistema de asientos múltiples. Revestimiento mural en tejido. Módulo lineal L 60 cm.



Peso / Weight / Poids / Gewicht / Peso **2 kg**

Imballo / Packaging / Emballage / Verpackung / Embalaje **0,18 m³**

Pezzi per scatola / Pieces per box / Pièces par carton / Stücke in einem Karton / Piezas por caja **4**





## 756

- > Sistema sedute multiple. Rivestimento a parete in tessuto. Modulo lineare L 120 cm.
- > Modular seating system. Upholstered wall panel. Linear module L 120 cm.
- > Système d'assises multiples. Revêtement mural en tissu. Element lineaire de 120 cm.
- > System aus mehreren Sitzmöbeln. Gepolsterte Wandverkleidung. Lineares Modul mit Länge von 120 cm.
- > Sistema de asientos múltiples. Revestimiento mural en tejido. Módulo lineal L 120 cm.

## 757

- > Sistema sedute multiple. Rivestimento a parete in tessuto. Modulo angolare terminale.
- > Modular seating system. Upholstered wall panel. Terminal corner module.
- > Système d'assises multiples. Revêtement mural en tissu. Element d'angle terminal.
- > System aus mehreren Sitzmöbeln. Gepolsterte Wandverkleidung. Terminaleckmodul.
- > Sistema de asientos múltiples. Revestimiento mural en tejido. Módulo de esquina final.

## 758

- > Sistema sedute multiple. Rivestimento a parete in tessuto. Modulo angolare (2 pezzi).
- > Modular seating system. Upholstered wall panel. Corner module (2 pieces).
- > Système d'assises multiples. Revêtement mural en tissu. Element d'angle (2 pièces).
- > System aus mehreren Sitzmöbeln. Gepolsterte Wandverkleidung. Eckmodul (2 Stücke).
- > Sistema de asientos múltiples. Revestimiento mural en tejido. Módulo de esquina (2 piezas).

## 759

- > Sistema sedute multiple. Sedile e schienale imbottiti. Telaio in tubo acciaio. Modulo curvo 45°/C (angolo chiuso).
- > Modular seating system. Upholstered seat and back. Steel frame. Curved module 45°/C (closed corner).
- > Système d'assises multiples. Assise et dossier rembourrés. Châssis en acier. Element courbe 45°/C (angle fermé).
- > System aus mehreren Sitzmöbeln. Gepolsterte Sitzfläche und Rückenlehne. Gestell aus Stahlrohren. Gerundetes Modul 45°/C (geschlossen).
- > Sistema de asientos múltiples. Asiento y respaldo tapizados. Estructura tubular en acero. Módulo curvado 45°/C (esquina cerrada).

## 760

- > Sistema sedute multiple. Sedile e schienale imbottiti. Telaio in tubo acciaio. Modulo curvo 45°/A (angolo aperto).
- > Modular seating system. Upholstered seat and back. Steel frame. Curved module 45°/A (opened corner).
- > Système d'assises multiples. Assise et dossier rembourrés. Châssis en acier. Element courbe 45°/A (angle ouvert).
- > System aus mehreren Sitzmöbeln. Gepolsterte Sitzfläche und Rückenlehne. Gestell aus Stahlrohren. Gerundetes Modul 45°/A (geöffnet).
- > Sistema de asientos múltiples. Asiento y respaldo tapizados. Estructura tubular en acero. Módulo curvado 45°/A (esquina abierta).

## 761

- > Sistema sedute multiple. Sedile imbottito. Telaio in tubo acciaio. Modulo curvo pouf 45°/A-C (aperto/chiuso).
- > Modular seating system. Upholstered seat. Steel frame. Curved pouf module 45°/A-C (pened/closed).
- > Système d'assises multiples. Assise rembourrée. Châssis en acier. Element courbe 45°/A-C (angle ouvert et fermé).
- > System aus mehreren Sitzmöbeln. Gepolsterte Sitzfläche. Gestell aus Stahlrohren. Pouf gerundetes Modul 45°/A-C (geöffnet und geschlossen).
- > Sistema de asientos múltiples. Asiento tapizado. Estructura tubular en acero. Módulo pouf curvado 45°/A-C (abierto/cerrada).



### Accessori / Accessories / Accessoires / Zubehoer / Accesorios

- > Cuscini cilindrici
- > Tubular cushions
- > Coussins cylindriques
- > Zylindrische Kissen
- > Cojines cilíndricos

## TE

- > Finiture seduta (vedi p. 375)
- > Seat finishes (see p. 375)
- > Finitions de l'assise (voir p. 375)
- > Sitzfertigungen (sehen S. 375)
- > Acabados asiento (ver p. 375)

## AC

- > Finiture telaio (vedi p. 397)
- > Frame finishes (see p. 397)
- > Finitions piètement (voir p. 397)
- > Gestell Fertigungen (sehen S. 397)
- > Acabados estructura (ver p. 397)

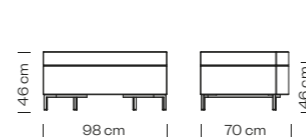
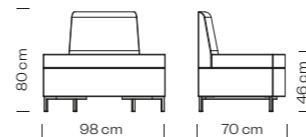
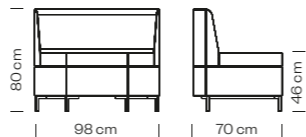
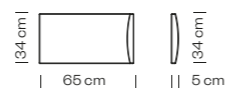

Peso / Weight / Poids / Gewicht / Peso **4 kg**

Imballo / Packaging / Emballage / Verpackung / Embalaje **0,18 m³**

Pezzi per scatola / Pieces per box / Pièces par carton / Stücke in einem Karton / Piezas por caja **4**

Peso / Weight / Poids / Gewicht / Peso **2 kg**

Imballo / Packaging / Emballage / Verpackung / Embalaje **0,18 m³**

Pezzi per scatola / Pieces per box / Pièces par carton / Stücke in einem Karton / Piezas por caja **4**

Peso / Weight / Poids / Gewicht / Peso **4 kg**

Imballo / Packaging / Emballage / Verpackung / Embalaje **0,18 m³**

Pezzi per scatola / Pieces per box / Pièces par carton / Stücke in einem Karton / Piezas por caja **2**

Peso / Weight / Poids / Gewicht / Peso **29 kg**

Imballo / Packaging / Emballage / Verpackung / Embalaje **0,60 m³**

Pezzi per scatola / Pieces per box / Pièces par carton / Stücke in einem Karton / Piezas por caja **1**

Peso / Weight / Poids / Gewicht / Peso **27,5 kg**

Imballo / Packaging / Emballage / Verpackung / Embalaje **0,60 m³**

Pezzi per scatola / Pieces per box / Pièces par carton / Stücke in einem Karton / Piezas por caja **1**

Peso / Weight / Poids / Gewicht / Peso **19 kg**

Imballo / Packaging / Emballage / Verpackung / Embalaje **0,35 m³**

Pezzi per scatola / Pieces per box / Pièces par carton / Stücke in einem Karton / Piezas por caja **1**



# echo

design  
rdm

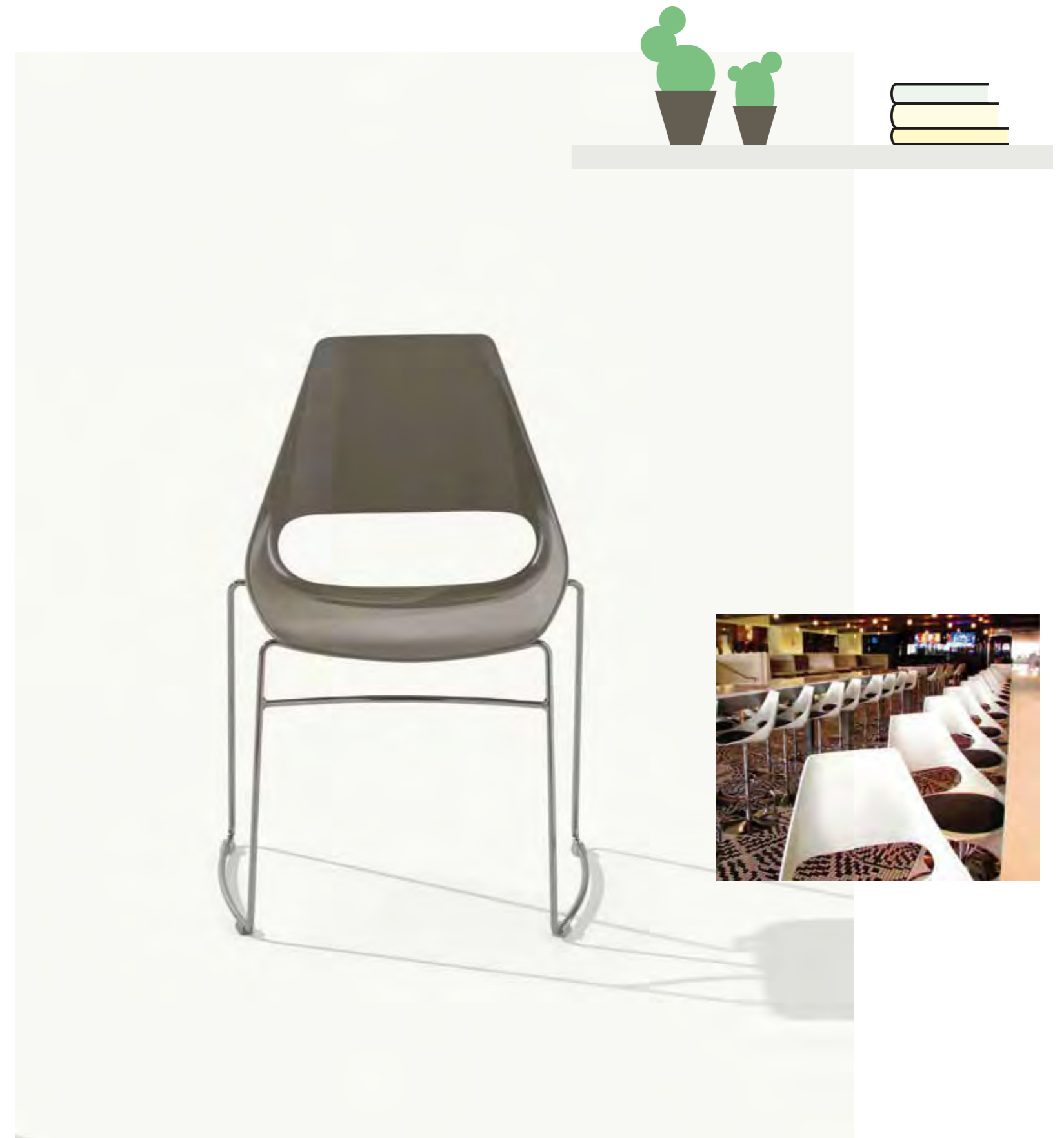

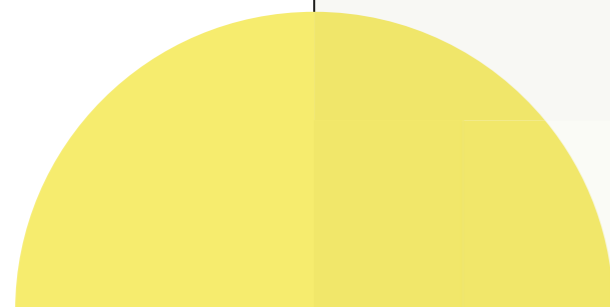

150

- > Sedia con telaio a 4 gambe in tubo acciaio. Seduta in tecnopolimero composito.
- > Chair with 4 legs steel frame and techno-polymer shell.
- > Chaise avec châssis en acier 4 pieds. Coque en techno-polymère.
- > Stuhl mit 4-beinigem Stahlgestell. Schale aus Zusammengesetztes Technopolymer.
- > Silla con estructura tubular 4 patas en acero. Carcasa en tecnopolímero compuesto.

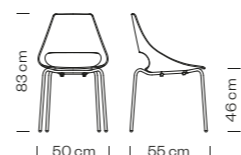

Peso / Weight / Poids / Gewicht / Peso

**5,6 kg**

Imballo / Packaging / Emballage / Verpackung / Embalaje

**0,39 m<sup>3</sup>**

Pezzi per scatola / Pieces per box / Pièces par carton / Stücke in einem Karton / Piezas por caja

**4**

Impilabile / Stackable / Empilable / Stapelbar / Apilable

**4**



152

- > Sedia con telaio a slitta in tondino acciaio. Seduta in tecnopolimero composito.
- > Chair with steel sled frame and techno-polymer shell.
- > Chaise avec châssis luge en fil d'acier. Coque en techno-polymère.
- > Stuhl mit Kufengestell aus Stahl. Schale aus Zusammengesetztes Technopolymer.
- > Silla con estructura patin en acero, carcasa en tecnopolímero compuesto.

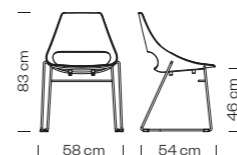

Peso / Weight / Poids / Gewicht / Peso

**7,5 kg**

Imballo / Packaging / Emballage / Verpackung / Embalaje

**0,40 m<sup>3</sup>**

Pezzi per scatola / Pieces per box / Pièces par carton / Stücke in einem Karton / Piezas por caja

**4**

Impilabile / Stackable / Empilable / Stapelbar / Apilable

**4**



152-G

- > Sedia con telaio a slitta in tondino acciaio e sistema aggancio. Seduta in tecnopolimero composito.
- > Chair with steel sled frame and linking device. Techno-polymer shell.
- > Chaise avec châssis luge et système d'accrochage en fil d'acier. Coque en techno-polymère.
- > Stuhl mit Kufengestell aus Stahl und Verbindungssystem. Schale aus Zusammengesetztes Technopolymer.
- > Silla con estructura patin en acero y sistema de enganche, carcasa en tecnopolímero compuesto.

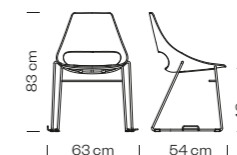

Peso / Weight / Poids / Gewicht / Peso

**8,1 kg**

Imballo / Packaging / Emballage / Verpackung / Embalaje

**0,40 m<sup>3</sup>**

Pezzi per scatola / Pieces per box / Pièces par carton / Stücke in einem Karton / Piezas por caja

**4**

Impilabile / Stackable / Empilable / Stapelbar / Apilable

**4**

Sistema di aggancio / Linking device / Système d'accrochage / Verbindungssystem / Sistema de enganche



153

- > Sedia con telaio a basamento centrale girevole in acciaio. Seduta in tecnopolimero composito.
- > Swivel chair with central steel base and technopolymer shell.
- > Chaise pivotante avec piètement central en acier, coque en techno-polymère.
- > Stuhl mit Untergestell und mittlerem Standfuss aus Stahl, drehbar. Sitzfläche aus Zusammengesetztes Technopolymer.
- > Silla giratoria con base central en acero. Carcasa en tecnopolímero compuesto.

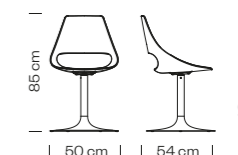

Peso / Weight / Poids / Gewicht / Peso

**9,9 kg**

Imballo / Packaging / Emballage / Verpackung / Embalaje

**0,29 m<sup>3</sup>**

Pezzi per scatola / Pieces per box / Pièces par carton / Stücke in einem Karton / Piezas por caja

**1**





# 156

- > Sedia con telaio da mensa in tubo acciaio. Seduta in tecnopolimero composito.
- > Canteen steel frame, with techno-polymer shell.
- > Chaise avec châssis en acier appui sur table, coque en techno-polymère.
- > Stuhl mit Gestell mit vorderem, offenem Fußbügel und Sitzfläche aus Zusammengesetztes Technopolymer.
- > Silla con estructura de comedor en acero. Carcasa en tecnopolimero compuesto.



# 332

- > Sgabello con telaio a 4 gambe in tubo acciaio. Seduta in tecnopolimero composito.
- > Barstool with 4 legs steel frame and techno-polymer shell.
- > Tabouret avec châssis en acier 4 pieds. Coque en techno-polymère.
- > Barhocker mit 4-beinigem Stahlgestell. Schale aus Zusammengesetztes Technopolymer.
- > Taburete con estructura tubular 4 patas en acero. Carcasa en tecnopolimero compuesto.



# 332B

- > Sgabello con telaio a 4 gambe in tubo acciaio. Seduta in tecnopolimero composito.
- > Barstool with 4 legs steel frame and techno-polymer shell. Versione seduta H 65 cm.
- > Tabouret avec châssis en acier 4 pieds. Coque en techno-polymère. Version hauteur assise 65 cm.
- > Barhocker mit 4-beinigem Stahlgestell. Schale aus Zusammengesetztes Technopolymer. Sitzhöhe 65 cm.
- > Taburete con estructura tubular 4 patas en acero. Carcasa en tecnopolimero compuesto. Altura asiento 65 cm.



# 333

- > Sgabello con telaio a basamento centrale in acciaio, girevole. Seduta in tecnopolimero composito.
- > Swivel barstool with central steel base and techno-polymer shell.
- > Tabouret pivotant avec piètement central en acier. Coque en techno-polymère.
- > Barhocker mit Gestell auf zentralem Standfuss aus Stahl. Schale aus Zusammengesetztes Technopolymer.
- > Taburete con estructura columna central en acero, giratoria. Carcasa en tecnopolimero compuesto.



# 333B

- > Sgabello con telaio a basamento centrale in acciaio, girevole. Seduta in tecnopolimero composito. Versione seduta H 65 cm.
- > Swivel barstool with central steel base and techno-polymer shell. Version seat-height H 65 cm.
- > Tabouret pivotant avec piètement central en acier. Coque en techno-polymère. Version hauteur assise 65 cm.
- > Barhocker mit Gestell auf zentralem Standfuss aus Stahl. Schale aus Zusammengesetztes Technopolymer. Sitzhöhe 65 cm.
- > Taburete con estructura columna central en acero, giratoria. Carcasa en tecnopolimero compuesto. Altura asiento 65 cm.

# PP+PET

- > Finiture seduta
- > Seat finishes
- > Finitions de l'assise
- > Sitzfertigungen
- > Acabados asiento

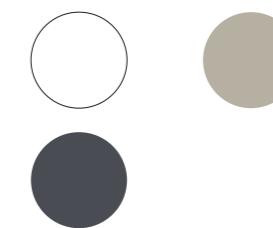

### Accessori / Accessories / Accessoires / Zubehoer / Accessories

- > Cuscino in feltro rimovibile
- > Loose felt cushion
- > Coussin en feutre amovible
- > Filz Kissen entfernbar
- > Cojín de fieltro removible



# AC

- > Finiture telaio (vedi p. 397)
- > Frame finishes (see p. 397)
- > Finitions piètement (voir p. 397)
- > Gestell Fertigungen (sehen S. 397)
- > Acabados estructura (ver p. 397)

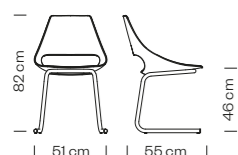

Peso / Weight / Poids / Gewicht / Peso **6 kg**

Imballo / Packaging / Emballage / Verpackung / Embalaje **0,35 m³**

Pezzi per scatola / Pieces per box / Pièces par carton / Stücke in einem Karton / Piezas por caja **2**

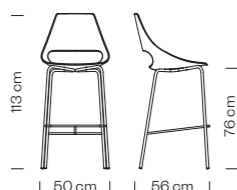

Peso / Weight / Poids / Gewicht / Peso **7 kg**

Imballo / Packaging / Emballage / Verpackung / Embalaje **0,35 m³**

Pezzi per scatola / Pieces per box / Pièces par carton / Stücke in einem Karton / Piezas por caja **1**

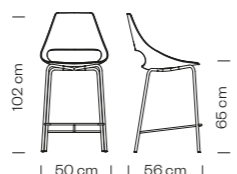

Peso / Weight / Poids / Gewicht / Peso **6,7 kg**

Imballo / Packaging / Emballage / Verpackung / Embalaje **0,35 m³**

Pezzi per scatola / Pieces per box / Pièces par carton / Stücke in einem Karton / Piezas por caja **1**

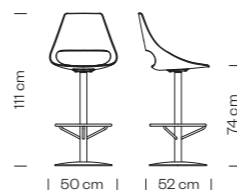

Peso / Weight / Poids / Gewicht / Peso **14 kg**

Imballo / Packaging / Emballage / Verpackung / Embalaje **0,35 m³**

Pezzi per scatola / Pieces per box / Pièces par carton / Stücke in einem Karton / Piezas por caja **1**

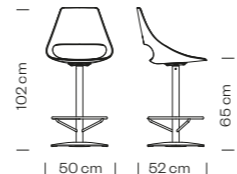

Peso / Weight / Poids / Gewicht / Peso **13,8 kg**

Imballo / Packaging / Emballage / Verpackung / Embalaje **0,35 m³**

Pezzi per scatola / Pieces per box / Pièces par carton / Stücke in einem Karton / Piezas por caja **1**

### Finiture / Finishes / Finitions / Fertigungen / Acabados



Woolfelt 504

Woolfelt 604

# kicca

design  
Francesco Geraci

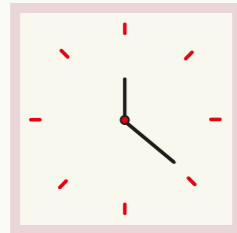

## 019

- > Poltroncina con telaio a basamento centrale girevole in acciaio. Sedile e schienale in tessuto.
- > Swivel armchair with central steel base. Upholstered seat and back.
- > Fauteuil pivotant avec piétement central en acier. Assise et dossier en tissu.
- > Armlehnstuhl mit Gestell auf zentralem, drehbarem Standfuss aus Stahl. Gepolsterte Sitzfläche und Rückenlehne.
- > Sillón con estructura columna central en acero, giratoria. Asiento y respaldo tapizados.



## 020

- > Poltroncina con telaio a 4 gambe in tubo acciaio. Sedile e schienale in tessuto.
- > Armchair with 4 legs steel frame and upholstered seat and back.
- > Fauteuil avec châssis 4 pieds en acier. Assise et dossier en tissu.
- > Armlehnstuhl mit 4-beinigem Stahlgestell. Gepolsterte Sitzfläche und Rückenlehne.
- > Sillón con estructura tubular 4 patas en acero. Asiento y respaldo tapizados.



## 021

- > Poltroncina con telaio a 4 razze in tubo acciaio. Sedile e schienale in tessuto.
- > Armchair with 4 ways steel frame. Upholstered seat and back.
- > Fauteuil avec châssis 4 branches en acier. Assise et dossier en tissu.
- > Armlehnstuhl mit 4-armigem Fusskreuz aus Stahl. Gepolsterte Sitzfläche und Rückenlehne.
- > Sillón con estructura tubular 4 radios en acero. Asiento y respaldo tapizados.



## 571

- > Poltroncina con telaio a 4 gambe in faggio. Sedile e schienale in tessuto.
- > Armchair with beech wood frame, 4 legs. Upholstered seat and back.
- > Fauteuil avec châssis 4 pieds en hêtre. Assise et dossier en tissu.
- > Armlehnstuhl mit 4-beinigem Buchenholzgestell. Gepolsterte Sitzfläche und Rückenlehne.
- > Sillón con estructura 4 patas en madera de haya. Asiento y respaldo tapizados.

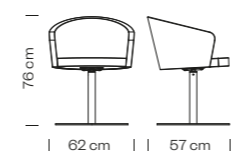

Peso / Weight / Poids / Gewicht / Peso **20 kg**

Imballo / Packaging / Emballage / Verpackung / Embalaje **0,32 m³**

Pezzi per scatola / Pieces per box / Pièces par carton / Stücke in einem Karton / Piezas por caja **1**

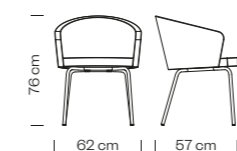

Peso / Weight / Poids / Gewicht / Peso **9,5 kg**

Imballo / Packaging / Emballage / Verpackung / Embalaje **0,32 m³**

Pezzi per scatola / Pieces per box / Pièces par carton / Stücke in einem Karton / Piezas por caja **1**

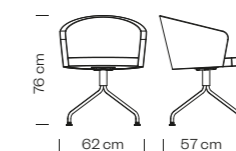

Peso / Weight / Poids / Gewicht / Peso **10 kg**

Imballo / Packaging / Emballage / Verpackung / Embalaje **0,32 m³**

Pezzi per scatola / Pieces per box / Pièces par carton / Stücke in einem Karton / Piezas por caja **1**

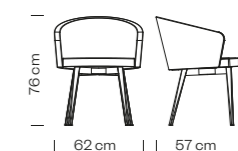

Peso / Weight / Poids / Gewicht / Peso **9,9 kg**

Imballo / Packaging / Emballage / Verpackung / Embalaje **0,32 m³**

Pezzi per scatola / Pieces per box / Pièces par carton / Stücke in einem Karton / Piezas por caja **1**



## 021-DP

- > Poltroncina con telaio in alluminio a 5 razze, girevole. Sedile e schienale in tessuto. Regolabile in altezza.
- > Swivel armchair with 5 ways aluminium frame. Upholstered seat and back. Adjustable seat height.
- > Fauteuil pivotant avec châssis en aluminium 5 branches avec patins. Assise et dossier en tissu. Réglable en hauteur.
- > Armlehnstuhl mit Aluminiumgestell, drehbar und mit 5-armigem Fusskreuz. Gepolsterte Sitzfläche und Rückenlehne. Höhenverstellbar.
- > Sillón con estructura 5 radios en aluminio, giratoria. Asiento y respaldo tapizados. Altura asiento regulable.



## 021-DR

- > Poltroncina con telaio in alluminio a 5 razze, girevole, su ruote. Sedile e schienale in tessuto. Regolabile in altezza.
- > Swivel armchair with 5 ways aluminium frame on castors. Upholstered seat and back. Adjustable seat height.
- > Fauteuil pivotant avec châssis en aluminium 5 branches avec roulettes. Assise et dossier en tissu. Réglable en hauteur.
- > Armlehnstuhl mit Aluminiumgestell, drehbar und mit 5-armigem Fusskreuz und Rollen. Gepolsterte Sitzfläche und Rückenlehne. Höhenverstellbar.
- > Sillón con estructura 5 radios en aluminio, giratoria, con ruedas. Asiento y respaldo tapizados. Altura asiento regulable.



## 320

- > Sgabello con telaio a basamento centrale girevole in acciaio. Sedile e schienale in tessuto.
- > Swivel stool with central steel base. Upholstered seat and back.
- > Tabouret pivotant avec piètement central en acier. Assise et dossier en tissu.
- > Barhocker mit Gestell auf zentralem, drehbarem Standfuss aus Stahl. Gepolsterte Sitzfläche und Rückenlehne.
- > Taburete con estructura columna central en acero, giratoria. Asiento y respaldo tapizados.



## 366

- > Sgabello con telaio a 4 gambe in tubo acciaio. Sedile e schienale in tessuto.
- > Barstool with steel frame and upholstered seat and back.
- > Tabouret avec châssis en acier 4 pieds. Assise et dossier en tissu.
- > Barhocker mit 4-beinigem Stahlgestell. Gepolsterte Sitzfläche und Rückenlehne.
- > Taburete con estructura tubular 4 patas en acero. Asiento y respaldo tapizados.

## TE

- > Finiture seduta (vedi p. 375)
- > Seat finishes (see p. 375)
- > Finitions de l'assise (voir p. 375)
- > Sitzfertigungen (sehen S. 375)
- > Acabados asiento (ver p. 375)

## AC

- > Finiture telaio (vedi p. 397)
- > Frame finishes (see p. 397)
- > Finitions piètement (voir p. 397)
- > Gestell Fertigungen (sehen S. 397)
- > Acabados estructura (ver p. 397)

## AL VR

- > Finiture telaio
- > Frame finishes
- > Finitions piètement
- > Gestell Fertigungen
- > Acabados estructura



## LE

- > Finiture telaio
- > Frame finishes
- > Finitions piètement
- > Gestell Fertigungen
- > Acabados estructura

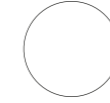

360°

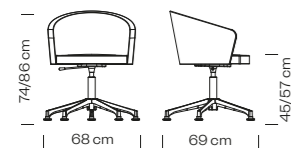

Peso / Weight / Poids / Gewicht / Peso **12 kg**

Imballo / Packaging / Emballage / Verpackung / Embalaje **0,39 m³**

Pezzi per scatola / Pieces per box / Pièces par carton / Stücke in einem Karton / Piezas por caja **1**

360°

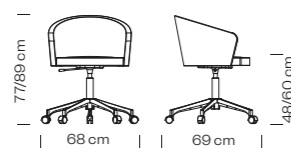

Peso / Weight / Poids / Gewicht / Peso **12 kg**

Imballo / Packaging / Emballage / Verpackung / Embalaje **0,39 m³**

Pezzi per scatola / Pieces per box / Pièces par carton / Stücke in einem Karton / Piezas por caja **1**

360°

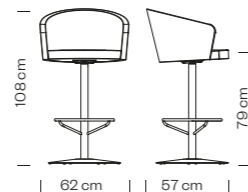

Peso / Weight / Poids / Gewicht / Peso **21,7 kg**

Imballo / Packaging / Emballage / Verpackung / Embalaje **0,44 m³**

Pezzi per scatola / Pieces per box / Pièces par carton / Stücke in einem Karton / Piezas por caja **1**

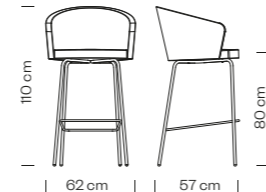

Peso / Weight / Poids / Gewicht / Peso **9,8 kg**

Imballo / Packaging / Emballage / Verpackung / Embalaje **0,44 m³**

Pezzi per scatola / Pieces per box / Pièces par carton / Stücke in einem Karton / Piezas por caja **1**

## AL PSH

- > Finiture telaio (vedi p. 399)
- > Frame finishes (see p. 399)
- > Finitions piètement (voir p. 399)
- > Gestell Fertigungen (sehen S. 399)
- > Acabados estructura (ver p. 399)



# net



design  
**Francesco Geraci**



## 096

- > Sedia con telaio a slitta e seduta in tondino acciaio.
- > Chair with steel sled frame.
- > Chaise avec châssis luge en fil d'acier.
- > Stuhl mit Kufengestell aus elektroverschweißten Stahlrohren.
- > Silla con estructura patín en acero.

## 097

- > Poltroncina con telaio a slitta e seduta in tondino acciaio.
- > Armchair with steel sled frame.
- > Fauteuil avec châssis luge en fil d'acier.
- > Armlehnstuhl mit Kufengestell aus elektroverschweißten Stahlrohren.
- > Sillón con estructura patín en acero.

## 396

- > Sgabello con telaio a slitta e seduta in tondino acciaio.
- > Barstool with steel sled frame.
- > Tabouret avec châssis luge en fil d'acier.
- > Barhocker mit Kufengestell aus elektroverschweißten Stahlrohren.
- > Taburete con estructura patín en acero.

## AC

- > Finiture seduta (vedi p. 397)
- > Seat finishes (see p. 397)
- > Finitions de l'assise (voir p. 397)
- > Sitzfertigungen (sehen S. 397)
- > Acabados asiento (ver p. 397)



Peso / Weight / Poids / Gewicht / Peso **5,3 kg**

Imballo / Packaging / Emballage / Verpackung / Embalaje **0,36 m<sup>3</sup>**

Pezzi per scatola / Pieces per box / Pièces par carton / Stücke in einem Karton / Piezas por caja **4**

Impilabile / Stackable / Empilable / Stapelbar / Apilable **4**



Peso / Weight / Poids / Gewicht / Peso **6,2 kg**

Imballo / Packaging / Emballage / Verpackung / Embalaje **0,36 m<sup>3</sup>**

Pezzi per scatola / Pieces per box / Pièces par carton / Stücke in einem Karton / Piezas por caja **4**

Impilabile / Stackable / Empilable / Stapelbar / Apilable **4**

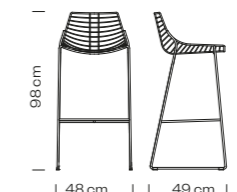

Peso / Weight / Poids / Gewicht / Peso **6 kg**

Imballo / Packaging / Emballage / Verpackung / Embalaje **0,25 m<sup>3</sup>**

Pezzi per scatola / Pieces per box / Pièces par carton / Stücke in einem Karton / Piezas por caja **1**



**Accessori / Accessories / Accessoires / Zubehoeren / Accesorios**

Cuscino In Tessuto / Cushion In Fabric / Coussin En Tissu / Kissen Aus Stoff / Cojin En Tejido /

# apple

design  
**Egidio Panzera**

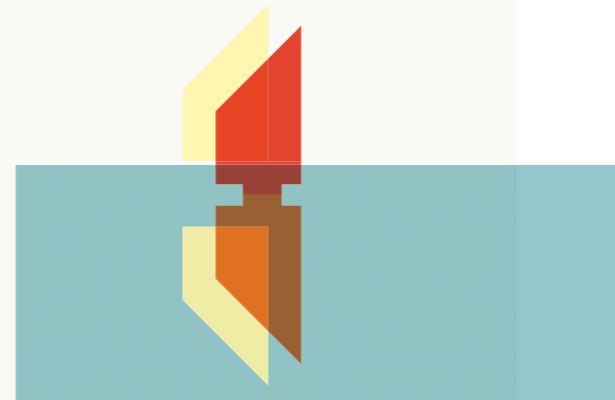

## P0009

- > Pouf in polietilene stampato in rotazionale.
- > Pouf in polyethylene, rotational moulding.
- > Pouf en polyéthylène roto-moulé.
- > Hocker aus Rotationsverfahren gepresstem Polyäthylen.
- > Pouf en polietileno moldeado rotativo.

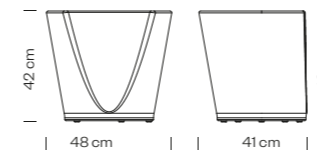

Peso / Weight /  
Poids / Gewicht / Peso **3,5 kg**

Imballo / Packaging /  
Emballage / Verpackung /  
Embalaje **0,19 m<sup>3</sup>**

Pezzi per scatola /  
Pieces per box /  
Pièces par carton /  
Stücke in einem Karton /  
Piezas por caja **2**

## PE

- > Finiture seduta
- > Seat finishes
- > Finitions de l'assise
- > Sitzfertigungen
- > Acabados asiento

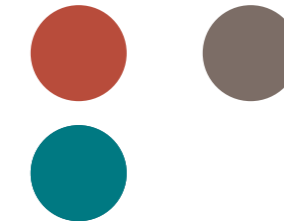

# luna

design  
rdm

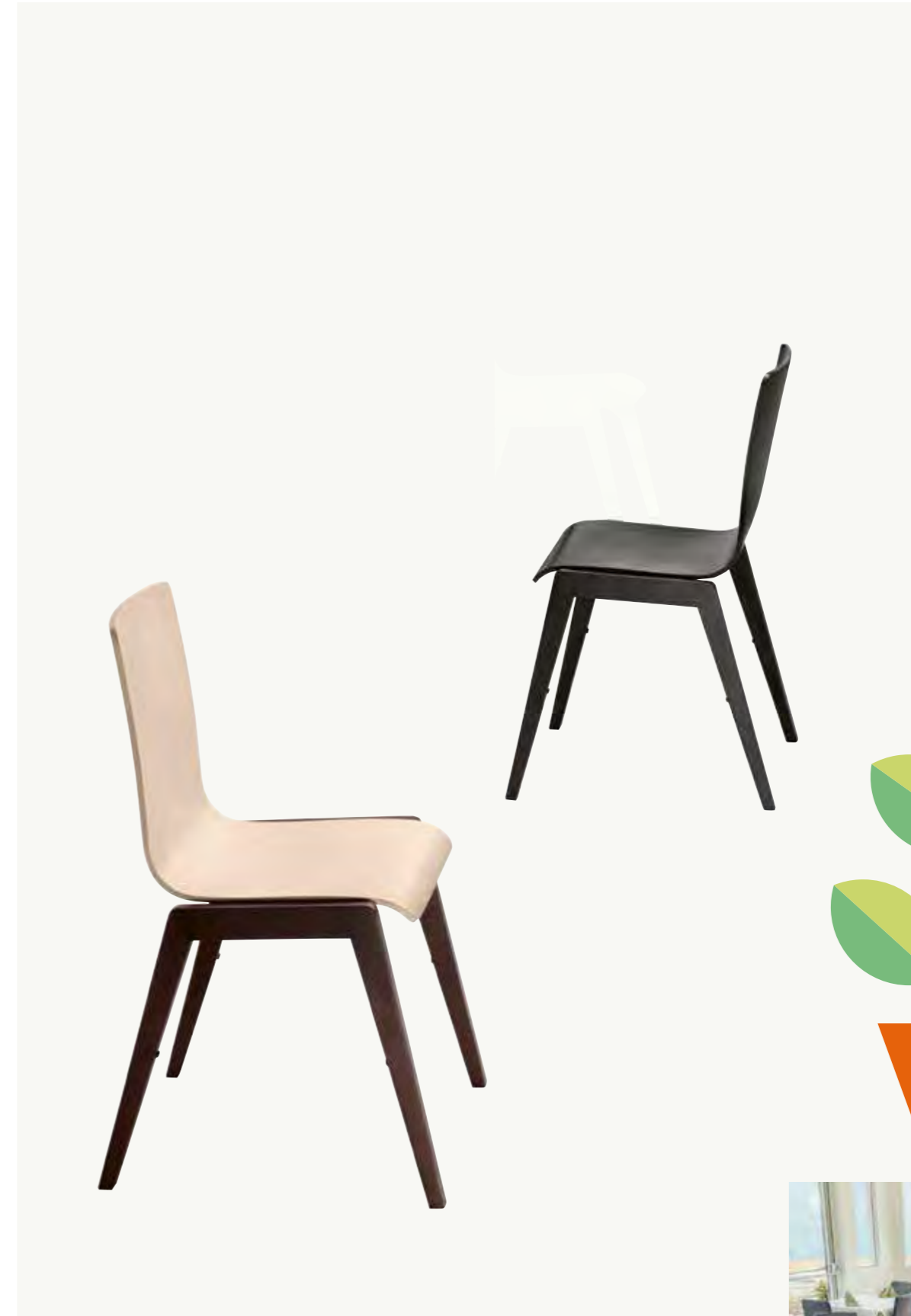
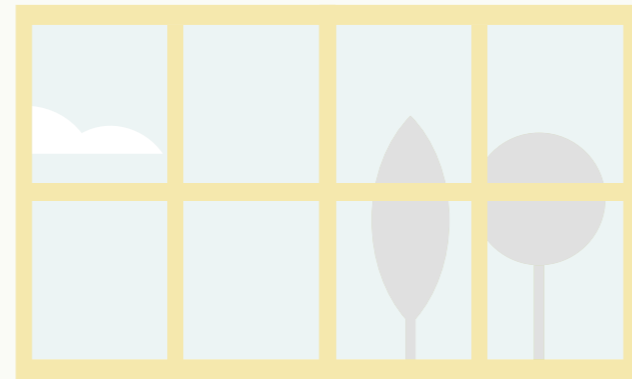





103

- > Sedia con telaio a 4 gambe in tubo quadrato acciaio. Sedile e schienale in tessuto o faggio.
- > Chair with 4 legs squared steel frame, upholstered or beech wood seat and back.
- > Chaise avec châssis 4 pieds en acier tube carré, coque en hêtre ou en tissu.
- > Stuhl mit 4-beinigem eckigen Stahlgestell. Sitzfläche und Rückenlehne gepolstert mit Stoff oder aus Buchenholz.
- > Silla con estructura tubular cuadrada 4 patas en acero. Asiento y respaldo tapizados o en madera de haya.



104

- > Sedia con telaio a 4 gambe in tubo tondo acciaio. Sedile e schienale in tessuto o faggio.
- > Chair with 4 legs steel frame, upholstered or beech wood seat and back.
- > Chaise avec châssis 4 pieds en acier tube rond, coque en hêtre ou en tissu.
- > Stuhl mit 4-beinigem runden Buchenholzgestell. Sitzfläche und Rückenlehne gepolstert mit Stoff oder aus Buchenholz.
- > Silla con estructura tubular redonda 4 patas en acero. Asiento y respaldo tapizados o en madera de haya.



107

- > Sedia con telaio a 4 gambe in faggio. Sedile e schienale in tessuto o faggio.
- > Chair with 4 legs steel tubular frame, upholstered or beech wood seat and back.
- > Chaise avec châssis 4 pieds en hêtre, coque en hêtre ou en tissu.
- > Stuhl mit 4-beinigem Buchenholzgestell. Sitzfläche und Rückenlehne gepolstert mit Stoff oder aus Buchenholz.
- > Silla con estructura 4 patas en madera de haya. Asiento y respaldo tapizados o en madera de haya.



330

- > Sgabello con telaio a basamento centrale girevole in acciaio. Sedile e schienale in tessuto o faggio.
- > Swivel barstool with central steel base. Upholstered or beech wood seat and back.
- > Tabouret pivotant avec piétement central en acier. Coque en hêtre ou en tissu.
- > Barhocker mit Gestell auf zentralem, drehbarem Standfuss aus Stahl. Sitzfläche und Rückenlehne gepolstert mit Stoff oder aus Buchenholz.
- > Taburete con estructura columna central en acero, giratoria. Asiento y respaldo tapizados o en madera de haya.



334

- > Sgabello con telaio a 4 gambe in tubo quadrato acciaio e sistema aggancio. Sedile e schienale in tessuto o faggio.
- > Barstool with 4 legs squared steel frame. Upholstered or beech wood seat and back.
- > Tabouret avec châssis 4 pieds en acier tube carré, coque en hêtre ou en tissu.
- > Barhocker mit 4-beinigem Stahlgestell. Sitzfläche und Rückenlehne gepolstert mit Stoff oder aus Buchenholz.
- > Taburete con estructura tubular cuadrada 4 patas en acero. Asiento y respaldo tapizados o en madera de haya.

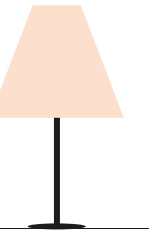

TE

- > Finiture seduta (vedi p. 375)
- > Seat finishes (see p. 375)
- > Finitions de l'assise (voir p. 375)
- > Sitzfertigungen (sehen S. 375)
- > Acabados asiento (ver p. 375)

AC

- > Finiture telaio (vedi p. 397)
- > Frame finishes (see p. 397)
- > Finitions piètement (voir p. 397)
- > Gestell Fertigungen (sehen S. 397)
- > Acabados estructura (ver p. 397)

LE

- > Finiture seduta
- > Seat finishes
- > Finitions de l'assise
- > Sitzfertigungen
- > Acabados asiento

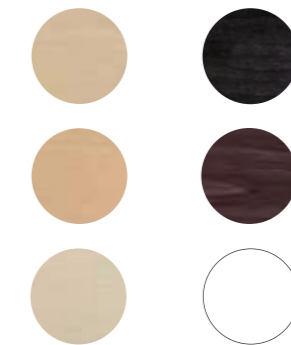

LE

- > Finiture telaio
- > Frame finishes
- > Finitions piètement
- > Gestell Fertigungen
- > Acabados estructura

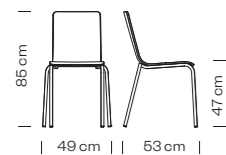
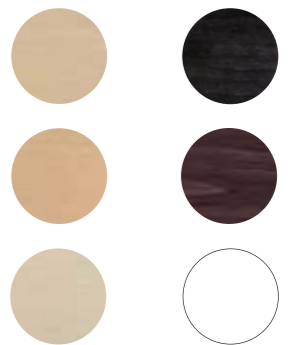

Peso / Weight / Poids / Gewicht / Peso **5,6 kg**

Imballo / Packaging / Emballage / Verpackung / Embalaje **0,39 m³**

Pezzi per scatola / Pieces per box / Pièces par carton / Stücke in einem Karton / Piezas por caja **4**

Impilabile / Stackable / Empilable / Stapelbar / Apilable **4\***

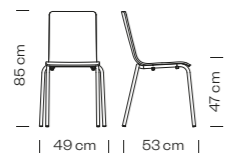

Peso / Weight / Poids / Gewicht / Peso **5,9 kg**

Imballo / Packaging / Emballage / Verpackung / Embalaje **0,39 m³**

Pezzi per scatola / Pieces per box / Pièces par carton / Stücke in einem Karton / Piezas por caja **4**

Impilabile / Stackable / Empilable / Stapelbar / Apilable **4\***

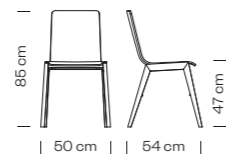

Peso / Weight / Poids / Gewicht / Peso **5,4 kg**

Imballo / Packaging / Emballage / Verpackung / Embalaje **0,39 m³**

Pezzi per scatola / Pieces per box / Pièces par carton / Stücke in einem Karton / Piezas por caja **2**

Impilabile / Stackable / Empilable / Stapelbar / Apilable **4**

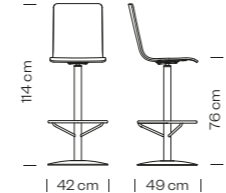

Peso / Weight / Poids / Gewicht / Peso **13,1 kg**

Imballo / Packaging / Emballage / Verpackung / Embalaje **0,29 m³**

Pezzi per scatola / Pieces per box / Pièces par carton / Stücke in einem Karton / Piezas por caja **1**

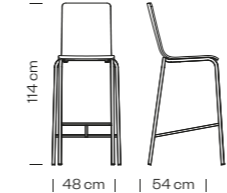

Peso / Weight / Poids / Gewicht / Peso **7,4 kg**

Imballo / Packaging / Emballage / Verpackung / Embalaje **0,50 m³**

Pezzi per scatola / Pieces per box / Pièces par carton / Stücke in einem Karton / Piezas por caja **2**



\* Non impilabile nella versione imbottita / Not stackable in the upholstered version / Non empilable dans la version rembourrée / Nicht stapelbar in der gepolsterten Version / No apilable en la version tapizada

**ibis**

design  
**Francesco Geraci**

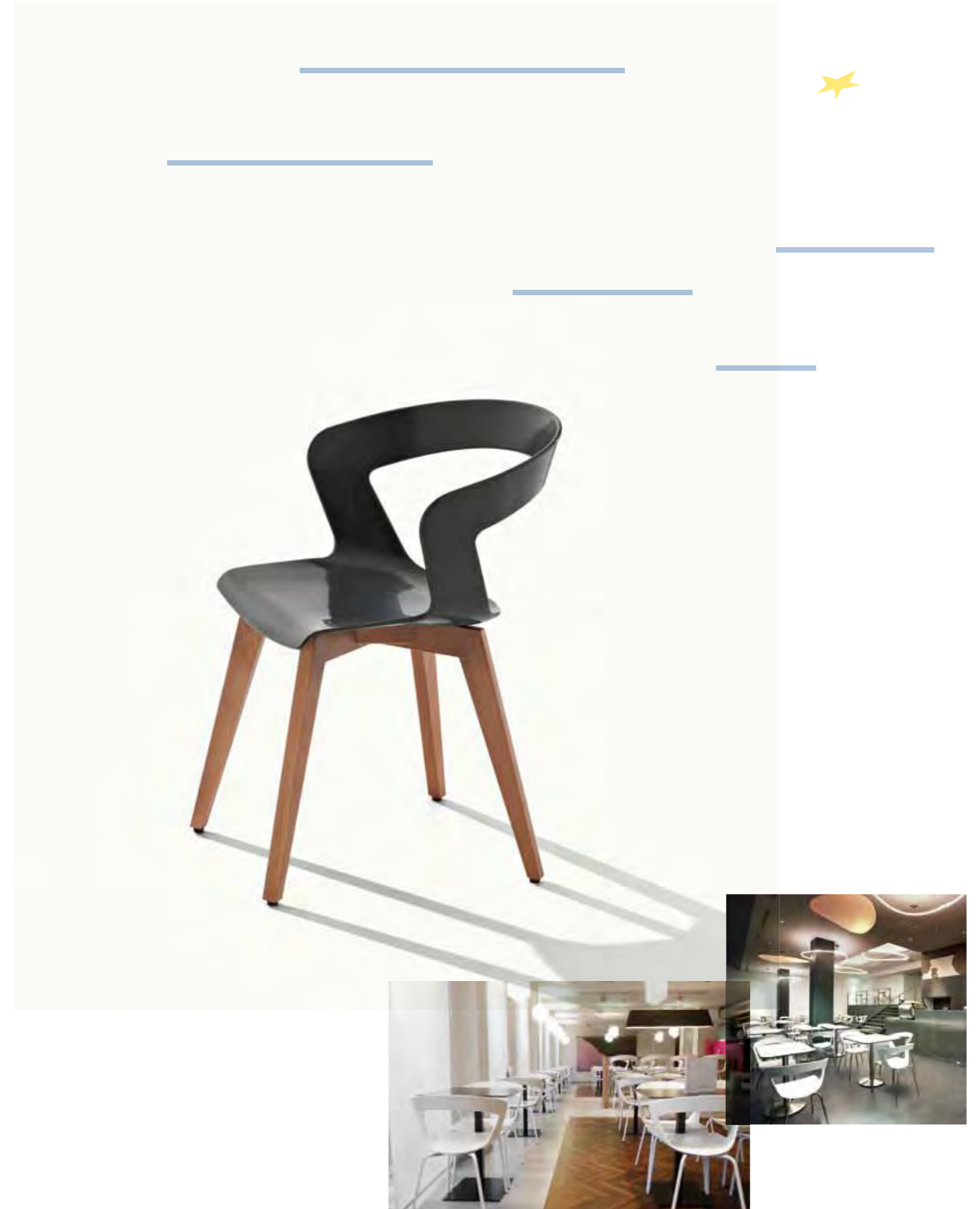
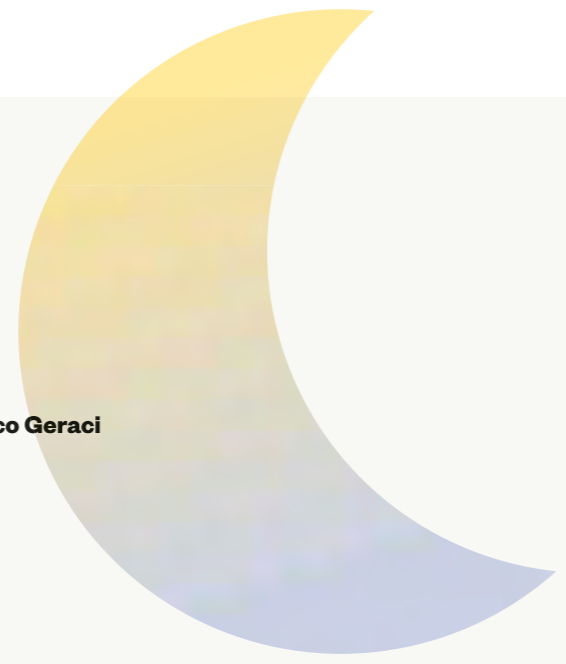



002

- > Poltroncina con telaio a 4 gambe in tubo acciaio. Seduta in tecnopolimero composito.
- > Armchair with 4 legs steel frame and techno-polymer shell.
- > Fauteuil avec châssis 4 pieds en acier. Coque en techno-polymère.
- > Armlehnstuhl mit 4-beinigem Stahlgestell. Schale aus Zusammengesetztes Technopolymer.
- > Sillón con estructura tubular 4 patas en acero. Carcasa en tecnopolímero compuesto.



160

- > Poltroncina con telaio a slitta in tondino acciaio. Seduta in tecnopolimero composito.
- > Armchair with steel sled frame and techno-polymer shell.
- > Fauteuil avec châssis luge en fil d'acier. Coque en techno-polymère.
- > Armlehnstuhl mit Kufengestell aus Stahl. Schale aus Zusammengesetztes Technopolymer.
- > Sillón con estructura patín en acero, carcasa en tecnopolímero compuesto.



160-G

- > Poltroncina con telaio a slitta in tondino acciaio e sistema aggancio. Seduta in tecnopolimero composito.
- > Armchair with steel sled frame and linking device. Techno-polymer shell.
- > Fauteuil avec châssis luge en fil d'acier avec système d'accrochage. Coque en techno-polymère.
- > Armlehnstuhl mit Kufengestell aus Stahl und Verbindungssystem. Schale aus Zusammengesetztes Technopolymer.
- > Sillón con estructura patín en acero y sistema de enganche, carcasa en tecnopolímero compuesto.



139

- > Poltroncina con telaio a 4 gambe in faggio. Seduta in tecnopolimero composito.
- > Armchair with 4 legs, beech wood frame. Techno-polymer shell.
- > Fauteuil avec châssis 4 pieds en hêtre. Coque en techno-polymère.
- > Armlehnstuhl mit 4-beinigem Buchenholzgestell. Schale aus Zusammengesetztes Technopolymer.
- > Sillón con estructura 4 patas en madera de haya, carcasa en tecnopolímero compuesto.



302

- > Sgabello con telaio a 4 gambe in tubo acciaio. Seduta in tecnopolimero composito.
- > Barstool with 4 legs steel frame and techno-polymer shell.
- > Tabouret avec châssis en acier 4 pieds. Coque en techno-polymère.
- > Barhocker mit 4-beinigem Stahlgestell. Schale aus Zusammengesetztes Technopolymer.
- > Taburete con estructura tubular 4 patas en acero, carcasa en tecnopolímero compuesto.

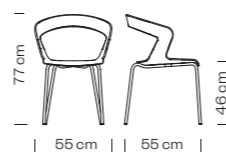

Peso / Weight / Poids / Gewicht / Peso **4,7 kg**

Imballo / Packaging / Emballage / Verpackung / Embalaje **0,39 m³**

Pezzi per scatola / Pieces per box / Pièces par carton / Stücke in einem Karton / Piezas por caja **4**

Impilabile / Stackable / Empilable / Stapelbar / Apilable **4**

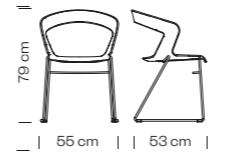

Peso / Weight / Poids / Gewicht / Peso **6,9 kg**

Imballo / Packaging / Emballage / Verpackung / Embalaje **0,39 m³**

Pezzi per scatola / Pieces per box / Pièces par carton / Stücke in einem Karton / Piezas por caja **4**

Impilabile / Stackable / Empilable / Stapelbar / Apilable **4**

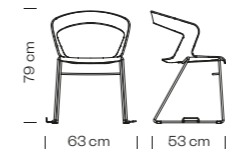

Peso / Weight / Poids / Gewicht / Peso **7,5 kg**

Imballo / Packaging / Emballage / Verpackung / Embalaje **0,39 m³**

Pezzi per scatola / Pieces per box / Pièces par carton / Stücke in einem Karton / Piezas por caja **4**

Impilabile / Stackable / Empilable / Stapelbar / Apilable **4**

Sistema di aggancio / Linking device / Système d'accrochage / Verbindungssystem / Sistema de enganche

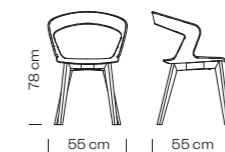

Peso / Weight / Poids / Gewicht / Peso **6 kg**

Imballo / Packaging / Emballage / Verpackung / Embalaje **0,34 m³**

Pezzi per scatola / Pieces per box / Pièces par carton / Stücke in einem Karton / Piezas por caja **1**



Peso / Weight / Poids / Gewicht / Peso **6,2 kg**

Imballo / Packaging / Emballage / Verpackung / Embalaje **0,35 m³**

Pezzi per scatola / Pieces per box / Pièces par carton / Stücke in einem Karton / Piezas por caja **1**





## 302B

- > Sgabello con telaio a 4 gambe in tubo acciaio. Seduta in tecnopolimero composito. Versione seduta H 65 cm.
- > Barstool with 4 legs steel frame and techno-polymer shell. Seat height H 65 cm.
- > Tabouret avec châssis en acier 4 pieds. Coque en techno-polymère. Hauteur assise 65 cm.
- > Barhocker mit Gestell auf zentralem Standfuss aus Stahl. Schale aus Zusammengesetztes Technopolymer. Sitzhöhe 65 cm.
- > Taburete con estructura tubular 4 patas en acero, carcasa en tecnopolimero compuesto. Altura asiento 65 cm.



## 303

- > Sgabello con telaio a basamento centrale in acciaio, girevole. Seduta in tecnopolimero composito.
- > Swivel barstool with central steel base and techno-polymer shell.
- > Tabouret pivotant avec piétement central en acier. Coque en techno-polymère.
- > Barhocker mit Gestell auf zentralem Standfuss aus Stahl. Schale aus Zusammengesetztes Technopolymer.
- > Taburete con estructura columna central en acero, giratoria. Carcasa en tecnopolimero compuesto.



## 303B

- > Sgabello con telaio a basamento centrale in acciaio, girevole. Seduta in tecnopolimero composito.
- > Swivel barstool with central steel base and techno-polymer shell. Versione seduta H 65 cm.
- > Tabouret pivotant avec piétement central en acier. Coque en techno-polymère. Version hauteur assise 65 cm.
- > Barhocker mit Gestell auf zentralem Standfuss aus Stahl. Schale aus Zusammengesetztes Technopolymer. Sitzhöhe 65 cm.
- > Taburete con estructura columna central en acero, giratoria. Carcasa en tecnopolimero compuesto. Altura asiento 65 cm.



## 002-DP

- > Poltroncina con telaio a 5 razze in alluminio, girevole. Seduta in tecnopolimero composito. Regolabile in altezza.
- > Swivel armchair with 5 ways aluminium frame. Techno-polymer shell. Adjustable seat height.
- > Fauteuil pivotant avec châssis en aluminium 5 branches avec patins. Coque en techno-polymère. Réglable en hauteur.
- > Armlehnstuhl mit Aluminiumgestell und 5-armigem Fusskreuz aus Aluminium. Schale aus Zusammengesetztes Technopolymer. Höhenverstellbar.
- > Sillón con estructura 5 radios en aluminio, giratoria, carcasa en tecnopolimero compuesto. Altura asiento regulable.



## 002-DR

- > Poltroncina con telaio a 5 razze in alluminio, girevole, su ruote. Seduta in tecnopolimero composito.
- > Swivel armchair with 5 ways on castors, aluminium frame. Techno-polymer shell.
- > Fauteuil pivotant avec châssis en aluminium 5 branches avec roulettes. Coque en techno-polymère.
- > Armlehnstuhl mit Aluminiumgestell und 5-armigem Fusskreuz und Rollen. Schale aus Zusammengesetztes Technopolymer.
- > Sillón con estructura 5 radios en aluminio, giratoria, con ruedas, carcasa en tecnopolimero compuesto.

### Accessori / Accessories / Accessoires / Zubehoer / Accesorios

- > Cuscino in feltro rimovibile
- > Loose felt cushion
- > Coussin en feutre amovible
- > Filz Kissen entfernbar
- > Cojín de fieltro removible



## PP+PET

- > Finiture seduta
- > Seat finishes
- > Finitions de l'assise
- > Sitzfertigung
- > Acabados asiento

## AC

- > Finiture telaio (vedi p. 397)
- > Frame finishes (see p. 397)
- > Finitions piètement (voir p. 397)
- > Gestell Fertigungen (sehen S. 397)
- > Acabados estructura (ver p. 397)

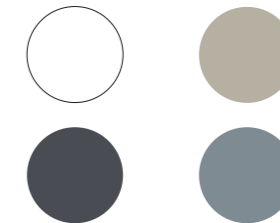

## AL PSH

- > Finiture telaio (vedi p. 399)
- > Frame finishes (see p. 399)
- > Finitions piètement (voir p. 399)
- > Gestell Fertigungen (sehen S. 399)
- > Acabados estructura (ver p. 399)

## AL VR

- > Finiture telaio
- > Frame finishes
- > Finitions piètement
- > Gestell Fertigungen
- > Acabados estructura



## LE

- > Finiture telaio
- > Frame finishes
- > Finitions piètement
- > Gestell Fertigungen
- > Acabados estructura

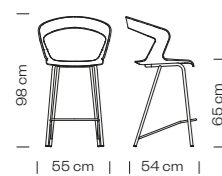

Peso / Weight / Poids / Gewicht / Peso **5,9 kg**

Imballo / Packaging / Emballage / Verpackung / Embalaje **0,35 m³**

Pezzi per scatola / Pieces per box / Pièces par carton / Stücke in einem Karton / Piezas por caja **1**

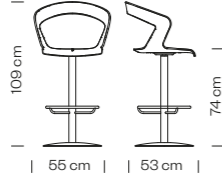

Peso / Weight / Poids / Gewicht / Peso **13,3 kg**

Imballo / Packaging / Emballage / Verpackung / Embalaje **0,35 m³**

Pezzi per scatola / Pieces per box / Pièces par carton / Stücke in einem Karton / Piezas por caja **1**

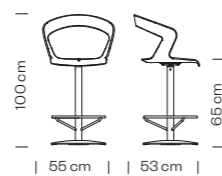

Peso / Weight / Poids / Gewicht / Peso **13 kg**

Imballo / Packaging / Emballage / Verpackung / Embalaje **0,35 m³**

Pezzi per scatola / Pieces per box / Pièces par carton / Stücke in einem Karton / Piezas por caja **1**

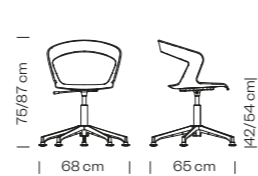

Peso / Weight / Poids / Gewicht / Peso **8,5 kg**

Imballo / Packaging / Emballage / Verpackung / Embalaje **0,39 m³**

Pezzi per scatola / Pieces per box / Pièces par carton / Stücke in einem Karton / Piezas por caja **1**

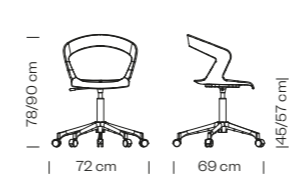

Peso / Weight / Poids / Gewicht / Peso **8,5 kg**

Imballo / Packaging / Emballage / Verpackung / Embalaje **0,39 m³**

Pezzi per scatola / Pieces per box / Pièces par carton / Stücke in einem Karton / Piezas por caja **1**

### Finiture / Finishes / Finitions / Fertigungen / Acabados



Woolfelt 504

Woolfelt 604

# boom

design  
Emilio Nanni



## P0007

- > Pouf imbottito.
- > Upholstered pouf.
- > Pouf rembourrée.
- > Gepolsterter Hocker.
- > Pouf tapizado.

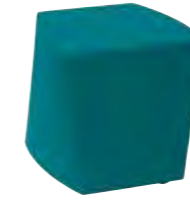

## P0008

- > Pouf in polietilene stampato in rotazionale.
- > Pouf in polyethylene, rotational moulding.
- > Pouf en polyéthylène roto-moulé.
- > Hocker aus im Rotationsverfahren gepresstem Polyäthylen.
- > Pouf en polietileno moldeado rotativo.

## PE

- > Finiture seduta
- > Seat finishes
- > Finitions de l'assise
- > Sitzfertigungen
- > Acabados asiento

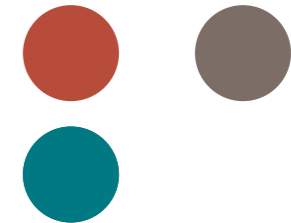

## TE

- > Finiture seduta (vedi p. 375)
- > Seat finishes (see p. 375)
- > Finitions de l'assise (voir p. 375)
- > Sitzfertigungen (sehen S. 375)
- > Acabados asiento (ver p. 375)

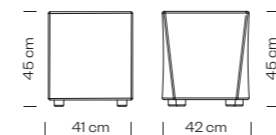

Peso / Weight / Poids / Gewicht / Peso **8,5 kg**

Imballo / Packaging / Emballage / Verpackung / Embalaje **0,18 m<sup>3</sup>**

Pezzi per scatola / Pieces per box / Pièces par carton / Stücke in einem Karton / Piezas por caja **2**

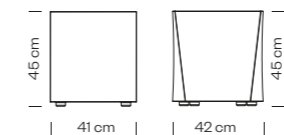

Peso / Weight / Poids / Gewicht / Peso **4 kg**

Imballo / Packaging / Emballage / Verpackung / Embalaje **0,16 m<sup>3</sup>**

Pezzi per scatola / Pieces per box / Pièces par carton / Stücke in einem Karton / Piezas por caja **2**



# space

design  
rdm

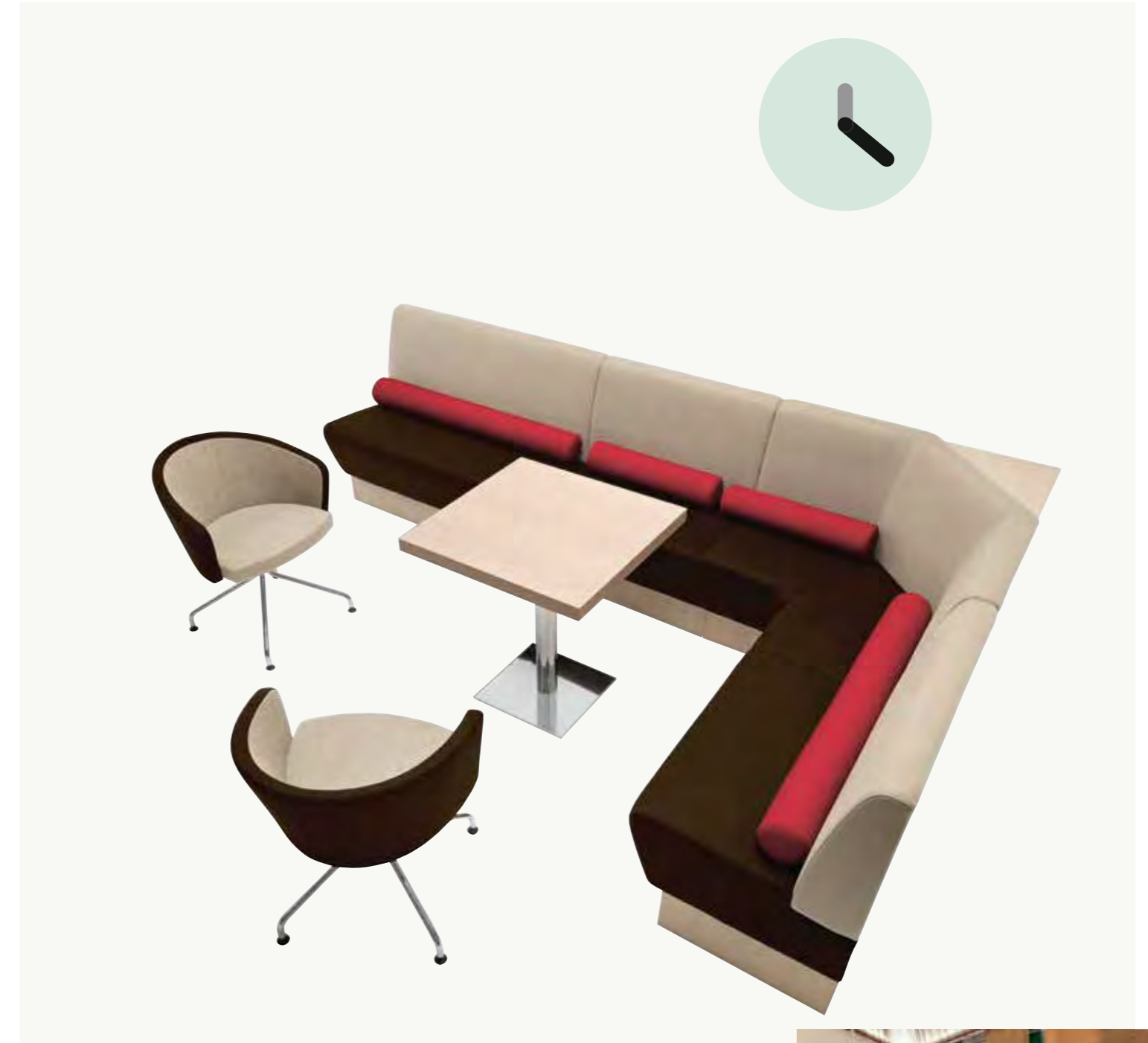



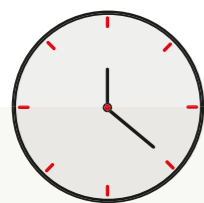

242

- > Sistema sedute multiple. Sedile e schienale imbottiti. Fianco, zoccolo e retro in laminato (fianco sp.2 cm). Modulo angolare. Versione schienale H 87 cm.
- > Modular seating system. Upholstered seat and back. Laminate front, side and rear (side thickness 2 cm). Corner module. Backrest H 87 cm.
- > Banquettes multiples. Assise et dossier rembourrés, revêtement en tissu, plinthe joues et arrière en stratifié (ep. 2 cm). Module d'angle. Version hauteur dossier 87 cm.
- > System aus mehreren Sitzmöbeln. Gepolsterte Sitzfläche und Rückenlehne. Seitenteil, Sockel und Hinten aus Laminat. (Seitenteil 2 cm Dicke). Eckiges Modul. Rückenlehne H 87 cm.
- > Sistema de asientos múltiples. Asiento y respaldo tapizados. Base frente, trasera y lado (Lado esp.2 cm) en laminado. Módulo de esquina. Altura respaldo 87 cm.

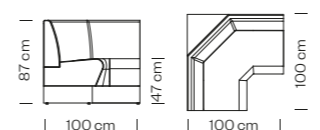

Peso / Weight / Poids / Gewicht / Peso **60 kg**

Imballo / Packaging / Emballage / Verpackung / Embalaje **1,05 m<sup>3</sup>**

Pezzi per scatola / Pieces per box / Pièces par carton / Stücke in einem Karton / Piezas por caja **1**



243

- > Sistema sedute multiple. Sedile e schienale imbottiti. Fianco, zoccolo e retro in laminato (fianco sp.2 cm). Modulo lineare 120 cm. Versione schienale H 87 cm.
- > Modular seating system. Upholstered seat and back. Laminate front, side and rear (side thickness 2 cm). Corner module. Backrest H 87 cm.
- > Banquettes multiples. Assise et dossier rembourrés, revêtement en tissu, plinthe joues et arrière en stratifié (ep. 2 cm). Module d'angle. Version hauteur dossier 87 cm.
- > System aus mehreren Sitzmöbeln. Gepolsterte Sitzfläche und Rückenlehne. Seitenteil, Sockel und Hinten aus Laminat. (Seitenteil 2 cm Dicke). Eckiges Modul. Rückenlehne H 87 cm.
- > Sistema de asientos múltiples. Asiento y respaldo tapizados. Base frente, trasera y lado (Lado esp.2 cm) en laminado. Módulo de esquina. Altura respaldo 87 cm.

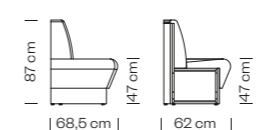

Peso / Weight / Poids / Gewicht / Peso **30 kg**

Imballo / Packaging / Emballage / Verpackung / Embalaje **0,50 m<sup>3</sup>**

Pezzi per scatola / Pieces per box / Pièces par carton / Stücke in einem Karton / Piezas por caja **1**



249

- > Sistema sedute multiple. Sedile e schienale imbottiti. Fianco, zoccolo e retro in laminato (fianco sp.2 cm). Modulo lineare 120 cm. Versione schienale H 87 cm.
- > Modular seating system. Upholstered seat and back. Laminate front, side and rear (side thickness 2 cm). Linear module 120 cm. Backrest H 87 cm.
- > Banquettes multiples. Assise et dossier rembourrés, revêtement en tissu, plinthe joues et arrière en stratifié (ep. 2 cm). Module linéaire 120 cm. Version hauteur dossier 87 cm.
- > System aus mehreren Sitzmöbeln. Gepolsterte Sitzfläche und Rückenlehne. Seitenteil, Sockel und Hinten aus Laminat. (Seitenteil 2 cm Dicke). Lineares Modul 120 cm. Rückenlehne H 87 cm.
- > Sistema de asientos múltiples. Asiento y respaldo tapizados. Base frente, trasera y lado (Lado esp.2 cm) en laminado. Módulo lineal L.120 cm. Altura respaldo 87 cm.

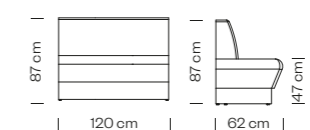

Peso / Weight / Poids / Gewicht / Peso **48,45 kg**

Imballo / Packaging / Emballage / Verpackung / Embalaje **0,82 m<sup>3</sup>**

Pezzi per scatola / Pieces per box / Pièces par carton / Stücke in einem Karton / Piezas por caja **1**



249 h120

- > Sistema sedute multiple. Sedile e schienale imbottiti. Fianco, zoccolo e retro in laminato (fianco sp.2 cm). Modulo lineare 120 cm. Versione schienale H 120 cm.
- > Modular seating system. Upholstered seat and back. Laminate front, side and rear (side thickness 2 cm). Linear module 120 cm. Backrest H 120 cm.
- > Banquettes multiples. Assise et dossier rembourrés, revêtement en tissu, plinthe joues et arrière en stratifié (ep. 2 cm). Module linéaire 120 cm. Version hauteur dossier 120 cm.
- > System aus mehreren Sitzmöbeln. Gepolsterte Sitzfläche und Rückenlehne. Seitenteil, Sockel und Hinten aus Laminat. (Seitenteil 2 cm Dicke). Lineares Modul 120 cm. Rückenlehne H 120 cm.
- > Sistema de asientos múltiples. Asiento y respaldo tapizados. Base frente, trasera y lado (Lado esp.2 cm) en laminado. Módulo lineal L.120 cm. Altura respaldo 120 cm.

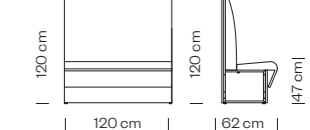

Peso / Weight / Poids / Gewicht / Peso **59,51 kg**

Imballo / Packaging / Emballage / Verpackung / Embalaje **1,20 m<sup>3</sup>**

Pezzi per scatola / Pieces per box / Pièces par carton / Stücke in einem Karton / Piezas por caja **1**



## 249 h160

- > Sistema sedute multiple. Sedile e schienale imbottiti. Fianco, zoccolo e retro in laminato (fianco sp.2 cm). Modulo lineare 120 cm. Versione schienale H 160 cm.
- > Modular seating system. Upholstered seat and back. Laminate front, side and rear (side thickness 2 cm). Linear module 120 cm. Backrest H 160 cm.
- > Banquettes multiples. Assise et dossier rembourrés, revêtement en tissu, plinthe joues et arrière en stratifié (ep. 2 cm). Module linéaire 120 cm. Version hauteur dossier H 160 cm.
- > System aus mehreren Sitzmöbeln. Gepolsterte Sitzfläche und Rückenlehne. Seitenteil, Sockel und Hinten aus Laminat. (Seitenteil 2 cm Dicke). Lineares Modul 120 cm. Rückenlehne H 160 cm.
- > Sistema de asientos múltiples. Asiento y respaldo tapizados. Base frente, trasera y lado (Lado esp. 2 cm) en laminado. Módulo lineal L.120 cm. Altura respaldo H 160 cm.



## 250

- > Sistema sedute multiple. Sedile e schienale imbottiti. Fianco, zoccolo e retro in laminato (fianco sp.2 cm). Modulo lineare 80 cm. Versione schienale H 87 cm.
- > Modular seating system. Upholstered seat and back. Laminate front, side and rear (side thickness 2 cm). Linear module 80 cm. Backrest H 87 cm.
- > Banquettes multiples. Assise et dossier rembourrés, revêtement en tissu, plinthe joues et arrière en stratifié (ep. 2 cm). Module linéaire 80 cm. Version hauteur dossier 87 cm.
- > System aus mehreren Sitzmöbeln. Gepolsterte Sitzfläche und Rückenlehne. Seitenteil, Sockel und Hinten aus Laminat. (Seitenteil 2 cm Dicke). Lineares Modul 80 cm. Rückenlehne H 87 cm.
- > Sistema de asientos múltiples. Asiento y respaldo tapizados. Base frente, trasera y lado (Lado esp. 2 cm) en laminado. Módulo lineal L.80 cm. Altura respaldo 87 cm.



## 250 h120

- > Sistema sedute multiple. Sedile e schienale imbottiti. Fianco, zoccolo e retro in laminato (fianco sp.2 cm). Modulo lineare 80 cm. Versione schienale H 120 cm.
- > Modular seating system. Upholstered seat and back. Laminate front, side and rear (side thickness 2 cm). Linear module 80 cm. Backrest H 120 cm.
- > Banquettes multiples. Assise et dossier rembourrés, revêtement en tissu, plinthe joues et arrière en stratifié (ep. 2 cm). Module linéaire 80 cm. Version hauteur dossier 87 cm.
- > System aus mehreren Sitzmöbeln. Gepolsterte Sitzfläche und Rückenlehne. Seitenteil, Sockel und Hinten aus Laminat. (Seitenteil 2 cm Dicke). Lineares Modul 80 cm. Rückenlehne H 120 cm.
- > Sistema de asientos múltiples. Asiento y respaldo tapizados. Base frente, trasera y lado (Lado esp. 2 cm) en laminado. Módulo lineal L.80 cm. Altura respaldo 120 cm.



## 250 h160

- > Sistema sedute multiple. Sedile e schienale imbottiti. Fianco, zoccolo e retro in laminato (fianco sp.2 cm). Modulo lineare 80 cm. Versione schienale H 160 cm.
- > Modular seating system. Upholstered seat and back. Laminate front, side and rear (side thickness 2 cm). Linear module 80 cm. Backrest H 160 cm.
- > Banquettes multiples. Assise et dossier rembourrés, revêtement en tissu, plinthe joues et arrière en stratifié (ep. 2 cm). Module linéaire 80 cm. Version hauteur dossier 160 cm.
- > System aus mehreren Sitzmöbeln. Gepolsterte Sitzfläche und Rückenlehne. Seitenteil, Sockel und Hinten aus Laminat. (Seitenteil 2 cm Dicke). Lineares Modul 80 cm. Rückenlehne H 160 cm.
- > Sistema de asientos múltiples. Asiento y respaldo tapizados. Base frente, trasera y lado (Lado esp. 2 cm) en laminado. Módulo lineal L.80 cm. Altura respaldo 160 cm.



## 251

- > Sistema sedute multiple. Sedile e schienale imbottiti. Fianco, zoccolo e retro in laminato (fianco sp.2 cm). Modulo lineare 70 cm. Versione schienale H 87 cm.
- > Modular seating system. Upholstered seat and back. Laminate front, side and rear (side thickness 2 cm). Linear module 70 cm. Backrest H 87 cm.
- > Banquettes multiples. Assise et dossier rembourrés, revêtement en tissu, plinthe joues et arrière en stratifié (ep. 2 cm). Module linéaire 70 cm. Version hauteur dossier 87 cm.
- > System aus mehreren Sitzmöbeln. Gepolsterte Sitzfläche und Rückenlehne. Seitenteil, Sockel und Hinten aus Laminat. (Seitenteil 2 cm Dicke). Lineares Modul 70 cm. Rückenlehne H 87 cm.
- > Sistema de asientos múltiples. Asiento y respaldo tapizados. Base frente, trasera y lado (Lado esp. 2 cm) en laminado. Módulo lineal L.70 cm. Altura respaldo 87 cm.



## 251 h120

- > Sistema sedute multiple. Sedile e schienale imbottiti. Fianco, zoccolo e retro in laminato (fianco sp.2 cm). Modulo lineare 70 cm. Versione schienale H 120 cm.
- > Modular seating system. Upholstered seat and back. Laminate front, side and rear (side thickness 2 cm). Linear module 70 cm. Backrest H 120 cm.
- > Banquettes multiples. Assise et dossier rembourrés, revêtement en tissu, plinthe joues et arrière en stratifié (ep. 2 cm). Module linéaire 70 cm. Version hauteur dossier 120 cm.
- > System aus mehreren Sitzmöbeln. Gepolsterte Sitzfläche und Rückenlehne. Seitenteil, Sockel und Hinten aus Laminat. (Seitenteil 2 cm Dicke). Lineares Modul 70 cm. Rückenlehne H 120 cm.
- > Sistema de asientos múltiples. Asiento y respaldo tapizados. Base frente, trasera y lado (Lado esp. 2 cm) en laminado. Módulo lineal L.70 cm. Altura respaldo 120 cm.



## 251 h160

- > Sistema sedute multiple. Sedile e schienale imbottiti. Fianco, zoccolo e retro in laminato (fianco sp.2 cm). Modulo lineare 70 cm. Versione schienale H 160 cm.
- > Modular seating system. Upholstered seat and back. Laminate front, side and rear (side thickness 2 cm). Linear module 70 cm. Backrest H 160 cm.
- > Banquettes multiples. Assise et dossier rembourrés, revêtement en tissu, plinthe joues et arrière en stratifié (ep. 2 cm). Module linéaire 70 cm. Version hauteur dossier 160 cm.
- > System aus mehreren Sitzmöbeln. Gepolsterte Sitzfläche und Rückenlehne. Seitenteil, Sockel und Hinten aus Laminat. (Seitenteil 2 cm Dicke). Lineares Modul 70 cm. Rückenlehne H 160 cm.
- > Sistema de asientos múltiples. Asiento y respaldo tapizados. Base frente, trasera y lado (Lado esp. 2 cm) en laminado. Módulo lineal L.70 cm. Altura respaldo 160 cm.



## 252

- > Sistema sedute multiple. Sedile e schienale imbottiti. Fianco, zoccolo e retro in laminato (fianco sp.2 cm). Modulo angolare. Versione schienale H 87 cm.
- > Modular seating system. Upholstered seat and back. Laminate front, side and rear (side thickness 2 cm). Corner module. Backrest H 87 cm.
- > Banquettes multiples. Assise et dossier rembourrés, revêtement en tissu, plinthe joues et arrière en stratifié (ep. 2 cm). Module d'angle. Version hauteur dossier 87 cm.
- > System aus mehreren Sitzmöbeln. Gepolsterte Sitzfläche und Rückenlehne. Seitenteil, Sockel und Hinten aus Laminat. (Seitenteil 2 cm Dicke). Eckiges Modul. Rückenlehne H 87 cm.
- > Sistema de asientos múltiples. Asiento y respaldo tapizados. Base frente, trasera y lado (Lado esp. 2 cm) en laminado. Módulo de esquina. Altura respaldo 87 cm.

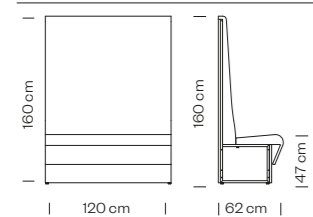

Peso / Weight / Poids / Gewicht / Peso **54 kg**

Imballo / Packaging / Emballage / Verpackung / Embalaje **1,55 m³**

Pezzi per scatola / Pieces per box / Pièces par carton / Stücke in einem Karton / Piezas por caja **1**

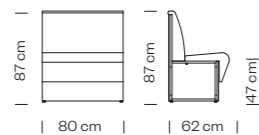

Peso / Weight / Poids / Gewicht / Peso **38 kg**

Imballo / Packaging / Emballage / Verpackung / Embalaje **0,56 m³**

Pezzi per scatola / Pieces per box / Pièces par carton / Stücke in einem Karton / Piezas por caja **1**

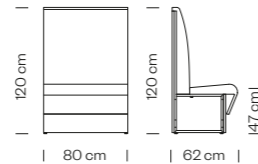

Peso / Weight / Poids / Gewicht / Peso **36 kg**

Imballo / Packaging / Emballage / Verpackung / Embalaje **0,82 m³**

Pezzi per scatola / Pieces per box / Pièces par carton / Stücke in einem Karton / Piezas por caja **1**

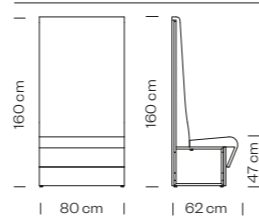

Peso / Weight / Poids / Gewicht / Peso **42 kg**

Imballo / Packaging / Emballage / Verpackung / Embalaje **1,07 m³**

Pezzi per scatola / Pieces per box / Pièces par carton / Stücke in einem Karton / Piezas por caja **1**

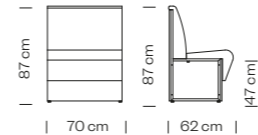

Peso / Weight / Poids / Gewicht / Peso **34 kg**

Imballo / Packaging / Emballage / Verpackung / Embalaje **0,50 m³**

Pezzi per scatola / Pieces per box / Pièces par carton / Stücke in einem Karton / Piezas por caja **1**

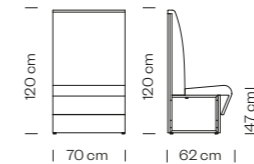

Peso / Weight / Poids / Gewicht / Peso **33 kg**

Imballo / Packaging / Emballage / Verpackung / Embalaje **0,73 m³**

Pezzi per scatola / Pieces per box / Pièces par carton / Stücke in einem Karton / Piezas por caja **1**

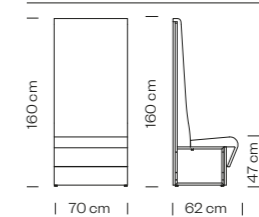

Peso / Weight / Poids / Gewicht / Peso **39 kg**

Imballo / Packaging / Emballage / Verpackung / Embalaje **0,95 m³**

Pezzi per scatola / Pieces per box / Pièces par carton / Stücke in einem Karton / Piezas por caja **1**

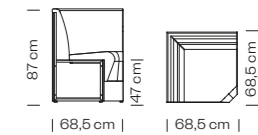

Peso / Weight / Poids / Gewicht / Peso **36 kg**

Imballo / Packaging / Emballage / Verpackung / Embalaje **0,50 m³**

Pezzi per scatola / Pieces per box / Pièces par carton / Stücke in einem Karton / Piezas por caja **1**



## 252 h120

- > Sistema sedute multiple. Sedile e schienale imbottiti. Fianco, zoccolo e retro in laminato (fianco sp.2 cm). Modulo angolare. Versione schienale H 120 cm.
- > Modular seating system. Upholstered seat and back. Laminate front, side and rear (side thickness 2 cm). Corner module. Backrest H 120 cm.
- > Banquettes multiples. Assise et dossier rembourrés, revêtement en tissu, plinthe joues et arrière en stratifié (ep. 2 cm). Module d'angle. Version hauteur dossier 120 cm.
- > System aus mehreren Sitzmöbeln. Gepolsterte Sitzfläche und Rückenlehne. Seitenteil, Sockel und Hinten aus Laminat. (Seitenteil 2 cm Dicke). Eckiges Modul. Rückenlehne H 120 cm.
- > Sistema de asientos múltiples. Asiento y respaldo tapizados. Base frente, trasera y lado (Lado esp.2 cm) en laminado. Módulo de esquina. Altura respaldo 120 cm.



## 252 h160

- > Sistema sedute multiple. Sedile e schienale imbottiti. Fianco, zoccolo e retro in laminato (fianco sp.2 cm). Modulo angolare. Versione schienale H 160 cm.
- > Modular seating system. Upholstered seat and back. Laminate front, side and rear (side thickness 2 cm). Corner module. Backrest H 160 cm.
- > Banquettes multiples. Assise et dossier rembourrés, revêtement en tissu, plinthe joues et arrière en stratifié (ep. 2 cm). Module d'angle. Version hauteur dossier 160 cm.
- > System aus mehreren Sitzmöbeln. Gepolsterte Sitzfläche und Rückenlehne. Seitenteil, Sockel und Hinten aus Laminat. (Seitenteil 2 cm Dicke). Eckiges Modul. Rückenlehne H 160 cm.
- > Sistema de asientos múltiples. Asiento y respaldo tapizados. Base frente, trasera y lado (Lado esp.2 cm) en laminado. Módulo de esquina. Altura respaldo 160 cm.



## 765

- > Sistema sedute multiple. Sedile e schienale imbottiti. Fianco, zoccolo e retro in laminato (fianco sp.2 cm). Modulo lineare 120 cm. Versione seduta H 75 cm.
- > Modular seating system. Upholstered seat and back. Laminate front, side and rear (side thickness 2 cm). Linear module 120 cm. Backrest H 75 cm.
- > Banquettes multiples. Assise et dossier rembourrés, revêtement en tissu, plinthe joues et arrière en stratifié (ep. 2 cm). Module linéaire 120 cm. Version hauteur assise 75 cm.
- > System aus mehreren Sitzmöbeln. Gepolsterte Sitzfläche und Rückenlehne. Seitenteil, Sockel und Hinten aus Laminat. (Seitenteil 2 cm Dicke). Lineares Modul 120 cm. Sitzhöhe H 75 cm.
- > Sistema de asientos múltiples. Asiento y respaldo tapizados. Base frente, trasera y lado (Lado esp.2 cm) en laminado. Módulo lineal L.120 cm. Altura asiento 75 cm.



## 766

- > Sistema sedute multiple. Sedile e schienale imbottiti. Fianco, zoccolo e retro in laminato (fianco sp.2 cm). Modulo lineare 80 cm. Versione seduta H 75 cm.
- > Modular seating system. Upholstered seat and back. Laminate front, side and rear (side thickness 2 cm). Linear module 80 cm. Backrest H 75 cm.
- > Banquettes multiples. Assise et dossier rembourrés, revêtement en tissu, plinthe joues et arrière en stratifié (ep. 2 cm). Module linéaire 80 cm. Version hauteur assise 75 cm.
- > System aus mehreren Sitzmöbeln. Gepolsterte Sitzfläche und Rückenlehne. Seitenteil, Sockel und Hinten aus Laminat. (Seitenteil 2 cm Dicke). Lineares Modul 80 cm. Sitzhöhe H 75 cm.
- > Sistema de asientos múltiples. Asiento y respaldo tapizados. Base frente, trasera y lado (Lado esp.2 cm) en laminado. Módulo lineal L.80 cm. Altura asiento 75 cm.



## 767

- > Sistema sedute multiple. Sedile e schienale imbottiti. Fianco, zoccolo e retro in laminato (fianco sp.2 cm). Modulo lineare 70 cm. Versione seduta H 75 cm.
- > Modular seating system. Upholstered seat and back. Laminate front, side and rear (side thickness 2 cm). Linear module 70 cm. Backrest H 75 cm.
- > Banquettes multiples. Assise et dossier rembourrés, revêtement en tissu, plinthe joues et arrière en stratifié (ep. 2 cm). Module linéaire 70 cm. Version hauteur assise 75 cm.
- > System aus mehreren Sitzmöbeln. Gepolsterte Sitzfläche und Rückenlehne. Seitenteil, Sockel und Hinten aus Laminat. (Seitenteil 2 cm Dicke). Lineares Modul 70 cm. Sitzhöhe H 75 cm.
- > Sistema de asientos múltiples. Asiento y respaldo tapizados. Base frente, trasera y lado (Lado esp.2 cm) en laminado. Módulo lineal L.70 cm. Altura asiento 75 cm.



## 768

- > Sistema sedute multiple. Sedile e schienale imbottiti. Fianco, zoccolo e retro in laminato (fianco sp.2 cm). Modulo angolare. Versione seduta H 75 cm.
- > Modular seating system. Upholstered seat and back. Laminate front, side and rear (side thickness 2 cm). Corner module. Backrest H 75 cm.
- > Banquettes multiples. Assise et dossier rembourrés, revêtement en tissu, plinthe joues et arrière en stratifié (ep. 2 cm). Module d'angle. Version hauteur assise 75 cm.
- > System aus mehreren Sitzmöbeln. Gepolsterte Sitzfläche und Rückenlehne. Seitenteil, Sockel und Hinten aus Laminat. (Seitenteil 2 cm Dicke). Eckiges Modul. Sitzhöhe H 75 cm.
- > Sistema de asientos múltiples. Asiento y respaldo tapizados. Base frente, trasera y lado (Lado esp.2 cm) en laminado. Módulo de esquina. Altura asiento 75 cm.

## TE

- > Finiture seduta (vedi p. 375)
- > Seat finishes (see p. 375)
- > Finitions de l'assise (voir p. 375)
- > Sitzfertigungen (sehen S. 375)
- > Acabados asiento (ver p. 375)

## LAM

- > Finiture telaio (vedi p. 408/409)
- > Frame finishes (see p. 408/409)
- > Finitions piètement (voir p. 408/409)
- > Gestell Fertigungen (sehen S. 408/409)
- > Acabados estructura (ver p. 408/409)

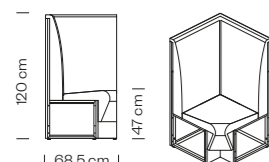

Peso / Weight / Poids / Gewicht / Peso **39 kg**

Imballo / Packaging / Emballage / Verpackung / Embalaje **0,69 m³**

Pezzi per scatola / Pieces per box / Pièces par carton / Stücke in einem Karton / Piezas por caja **1**

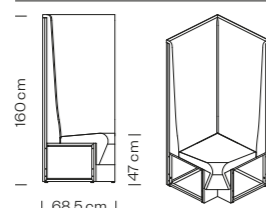

Peso / Weight / Poids / Gewicht / Peso **46 kg**

Imballo / Packaging / Emballage / Verpackung / Embalaje **0,91 m³**

Pezzi per scatola / Pieces per box / Pièces par carton / Stücke in einem Karton / Piezas por caja **1**

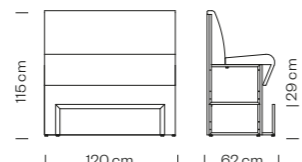

Peso / Weight / Poids / Gewicht / Peso **66 kg**

Imballo / Packaging / Emballage / Verpackung / Embalaje **1,09 m³**

Pezzi per scatola / Pieces per box / Pièces par carton / Stücke in einem Karton / Piezas por caja **1**

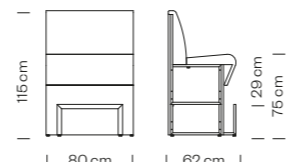

Peso / Weight / Poids / Gewicht / Peso **47 kg**

Imballo / Packaging / Emballage / Verpackung / Embalaje **0,76 m³**

Pezzi per scatola / Pieces per box / Pièces par carton / Stücke in einem Karton / Piezas por caja **1**

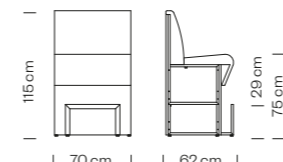

Peso / Weight / Poids / Gewicht / Peso **42 kg**

Imballo / Packaging / Emballage / Verpackung / Embalaje **0,63 m³**

Pezzi per scatola / Pieces per box / Pièces par carton / Stücke in einem Karton / Piezas por caja **1**

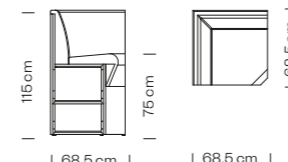

Peso / Weight / Poids / Gewicht / Peso **46 kg**

Imballo / Packaging / Emballage / Verpackung / Embalaje **0,64 m³**

Pezzi per scatola / Pieces per box / Pièces par carton / Stücke in einem Karton / Piezas por caja **1**



### Accessori / Accessories / Accessoires / Zubehoer / Accesorios

- > Cuscini cilindrici
- > Tubular cushions
- > Coussins cylindriques
- > Zylindrische Kissen
- > Cojines cilindricos



# 001

design  
rdm, 1956

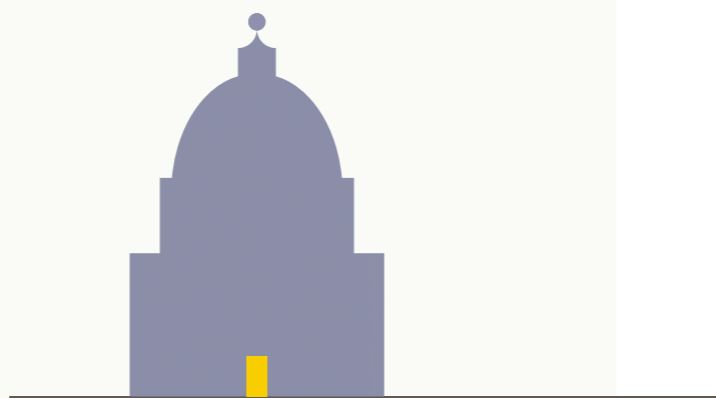

## 001

- > Poltroncina con telaio 4 gambe in tubo acciaio con sedile e schienale in Xiloplast.
- > Armchair with 4 legs steel frame. Seat and back in Xiloplast.
- > Fauteuil avec châssis 4 pieds en acier, assise et dossier en Xiloplast.
- > Armlehnstuhl mit 4-beinigem Stahlgestell. Sitzfläche und Rückenlehne aus Xiloplast.
- > Sillón con estructura tubular 4 patas en acero, asiento y respaldo en xiloplast.

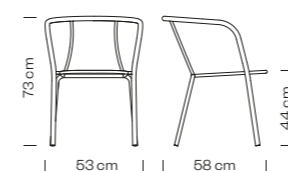

Peso / Weight / Poids / Gewicht / Peso **5,5 kg**

Imballo / Packaging / Emballage / Verpackung / Embalaje **0,32 m³**

Pezzi per scatola / Pieces per box / Pièces par carton / Stücke in einem Karton / Piezas por caja **4**

Impilabile / Stackable / Empilable / Stapelbar / Apilable **8**

## XLP

- > Finiture seduta
- > Seat finishes
- > Finitions de l'assise
- > Sitzfertigungen
- > Acabados asiento



## AC

- > Finiture telaio (vedi p. 397)
- > Frame finishes (see p. 397)
- > Finitions piètement (voir p. 397)
- > Gestell Fertigungen (sehen S. 397)
- > Acabados estructura (ver p. 397)



# harvey

design  
**Francesco Faccin**







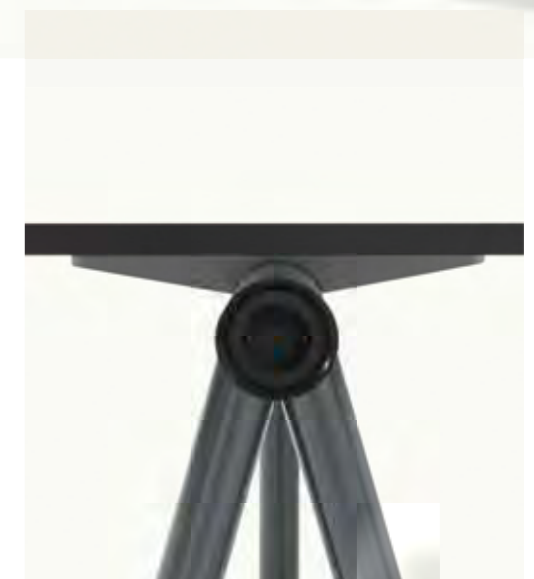
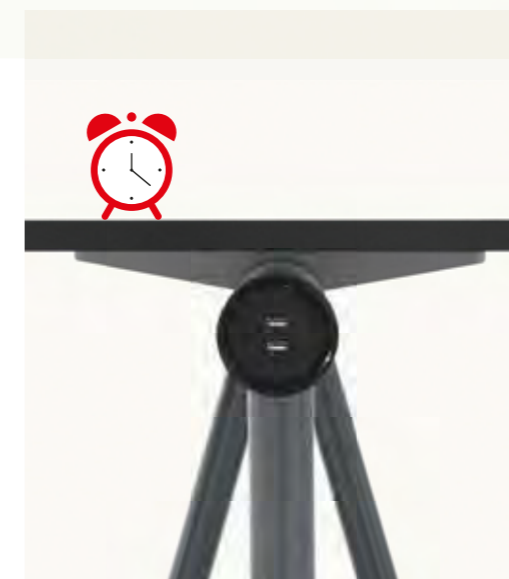



- > Supporti per fissaggio piani in fusione di alluminio disponibili:
- verniciati Rosso Corallo NCS S3060-Y80R (per cavalletti verniciati Nero NCS S9000-N, Bianco traffico NCS S0502-B e Bianco puro NCS S0500-N)
- alluminio (per cavalletti verniciati negli altri colori).



- > Supports for table top fixing in cast aluminium available:
- coated in Coral red NCS S3060-Y80R (for easels coated in black NCS S9000-N, Traffic white NCS S0502-B and Pure white NCS S0500-N)
- aluminium (for easels coated in the other colors).



- > Supports de fixation des plateaux en fonte d'aluminium disponibles:
- laqué en rouge corail NCS S3060-Y80R (pour les chevalets laqués en noir NCS S9000-N, blanc signalisation NCS S0502-B et blanc pur NCS S0500-N)
- aluminium (pour les chevalets laqués dans les autres couleurs).



- > Unterstützung für die Tischplattenbefestigung in Aluminiumguss erhältlich:
- lackiert Korallenrot NCS S3060-Y80R (für Werkbank lackiert Schwarz NCS S9000-N, Verkehrsweiß NCS S0502-B und Reinweiß NCS S0500-N)
- Aluminium (für Werkbank, die in den anderen Farben lackiert sind).

- > Soportes para fijación de encimeras en fundición de aluminio disponibles:
- pintado rojo coral NCS S3060-Y80R (para tripodes pintados negro NCS S9000-N, blanco tráfico NCS S0502-B y blanco puro NCS S0500-N)
- aluminio (para tripodes pintados negro en los otros colores).



## 1130

- > n.2 cavalletti in tubo d'acciaio con supporti per fissaggio piano in fusione alluminio e tappetino in gomma. Ogni cavalletto è dotato di 1 presa Schuko e 2 prese USB.
- > n.2 steel tube easels with support for table top fixing in cast aluminium and rubber pads. Each easel is equipped with 1 schuko socket and 2 USB sockets.
- > n.2 chevalets en tube d'acier avec supports de fixation du plateau en fonte d'aluminium. Chaque chevalet est équipé d'une prise Schuko et de 2 prises USB-A.
- > n.2 Stahlrohrböcke mit oberen Befestigungsklammern aus Aluminiumguss. Jede Stahlrohrbock ist mit einem Schuko-Stecker und 2 USB-ABuchsen ausgestattet.
- > n.2 tripodes en tubo de acero con soporte en fundición de aluminio y tapete en goma para fijación encimera. Cada tripode está equipado con 1 enchufe Schuko y 2 cargadores USB.

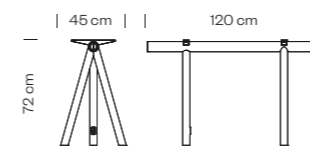

Peso / Weight / Poids / Gewicht / Peso **18,6 Kg**

Imballo / Packaging / Emballage / Verpackung / Embalaje **0,74 m³**

Pezzi per scatola / Pieces for box / Pièces par carton / Stücke in einem Karton / Piezas por caja **2**

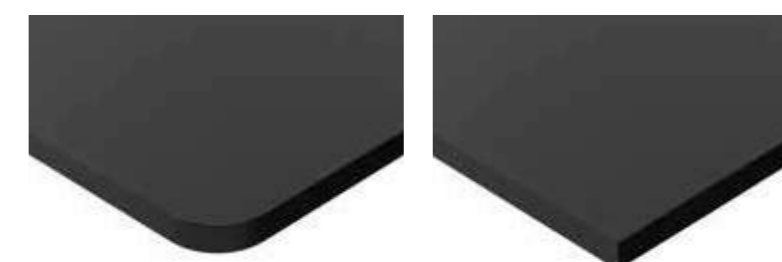

## AC

- > Finiture telaio (vedi p. 397)
- > Frame finishes (see p. 397)
- > Finitions piètement (voir p. 397)
- > Gestell Fertigungen (sehen S. 397)
- > Acabados estructura (ver p. 397)

## LAM

- > Finiture piani tavoli
- > Table tops finishes
- > finitions plateaux de table
- > Tischplattenfertigungen
- > acabados por sobres de mesas

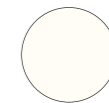

Arpa 020



Fenix NTM 0720 NERO INGO

Antimpronta / Anti-fingerprints / Anti-empreintes / Antifingerabdrücke / Antihuella

Piani / Table top / Plateaux de table / Tischplatte / Encimera de

angoli a spigolo- angolo 90° / squared edge - 90° angle / angles carrés - angle à 90° / quadratische Winkel - Ecke 90° / con esquina recta - esquina 90°

angolo arrondato / rounded angle / angle arrondi / gerundete Ecke / esquina redondeada

# milos

design  
Marc Sadler





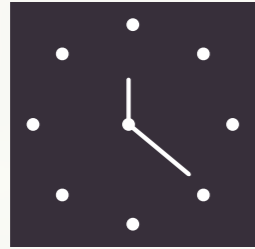









1140

- > Tavolo con basamento e colonna in alluminio. H 42cm
- > Table frame with aluminium base and column. H 42cm
- > Piètement de table avec embase et colonne en aluminium. H 42cm
- > Tischgestell mit Säule und Bodenplatte aus Aluminium. H 42cm
- > Base de mesa con patas y columna en aluminio, altura 42 cm

Piani tavolo / Table Tops / Plateaux de table / Tischplatten / Encimera de  
 Ø 60 cm  
 Ø 70 cm  
 Ø 80 cm  
 60x60 cm  
 70x70 cm  
 80x80 cm



1141

- > Tavolo con basamento e colonna in alluminio. H 72cm
- > Table frame with aluminium base and column. H 72cm
- > Piètement de table avec embase et colonne en aluminium. H 72cm
- > Tischgestell mit Säule und Bodenplatte aus Aluminium. H 72cm
- > Base de mesa con patas y columna en aluminio, altura 72 cm

Piani tavolo / Table Tops / Plateaux de table / Tischplatten / Encimera de  
 Ø 60 cm  
 Ø 70 cm  
 Ø 80 cm  
 60x60 cm  
 70x70 cm  
 80x80 cm



1142

- > Tavolo con basamento e colonna in alluminio. H 105cm
- > Table frame with aluminium base and column. H 105cm
- > Piètement de table avec embase et colonne en aluminium. H 105cm
- > Tischgestell mit Säule und Bodenplatte aus Aluminium. H 105cm
- > Base de mesa con patas y columna en aluminio, altura 105 cm

Piani tavolo / Table Tops / Plateaux de table / Tischplatten / Encimera de  
 Ø 60 cm  
 Ø 70 cm  
 Ø 80 cm  
 60x60 cm  
 70x70 cm

AL VR

- > Finiture telaio (vedi p. 400)
- > Frame finishes (see p. 400)
- > Finitions piètement (voir p. 400)
- > Gestell Fertigungen (sehen S. 400)
- > Acabados estructura (ver p. 400)

AL PSH

- > Finiture telaio (vedi p. 399)
- > Frame finishes (see p. 399)
- > Finitions piètement (voir p. 399)
- > Gestell Fertigungen (sehen S. 399)
- > Acabados estructura (ver p. 399)

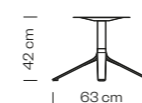

Peso / Weight / Poids / Gewicht / Peso **7 kg**

Imballo / Packaging / Emballage / Verpackung / Embalaje **0,12 m³**

Pezzi per scatola / Pieces for box / Pièces par carton / Stücke in einem Karton / Piezas por caja **3**

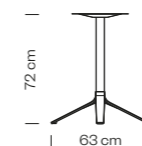

Peso / Weight / Poids / Gewicht / Peso **7,7 kg**

Imballo / Packaging / Emballage / Verpackung / Embalaje **0,12 m³**

Pezzi per scatola / Pieces for box / Pièces par carton / Stücke in einem Karton / Piezas por caja **3**

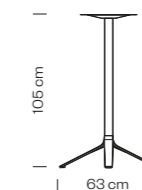

Peso / Weight / Poids / Gewicht / Peso **8,5 kg**

Imballo / Packaging / Emballage / Verpackung / Embalaje **0,17 m³**

Pezzi per scatola / Pieces for box / Pièces par carton / Stücke in einem Karton / Piezas por caja **3**

# noodle

design  
**Ana Kraš**











1080

- > Tavolino con telaio in tondino acciaio. Versione H 30/31 cm. Piano in lamiera acciaio Ø 50.
- > Coffee table with steel frame. Version H 30/31 cm. Top in sheet steel Ø 50.
- > Table basse avec structure en acier. Version H 30/31 cm. Plateau en tôle d'acier Ø 50.
- > Couchtisch mit Stahlgestell. Version H 30/31 cm. Platte aus Stahlblech Ø 50.
- > Mesa baja en acero. Versión H 30/31 cm. Sobre de mesa en chapa de acero Ø 50.



Peso / Weight / Poids / Gewicht / Peso **6,1 Kg**

Imballo / Packaging / Emballage / Verpackung / Embalaje **0,13 m³**

Pezzi per scatola / Pieces for box / Pièces par carton / Stücke in einem Karton / Piezas por caja **2**



1081

- > Tavolino con telaio in tondino acciaio. Versione H 42/43 cm. Piano in lamiera acciaio Ø 42.
- > Coffee table with steel frame. Version H 42/43 cm. Top in sheet steel Ø 42.
- > Table basse avec structure en acier. Version H 42/43 cm. Plateau en tôle d'acier Ø 42.
- > Couchtisch mit Stahlgestell. Version H 42/43 cm. Platte aus Stahlblech Ø 42.
- > Mesa baja en acero. Versión H 42/43 cm. Sobre de mesa en chapa de acero Ø 42.



Peso / Weight / Poids / Gewicht / Peso **5,9 Kg**

Imballo / Packaging / Emballage / Verpackung / Embalaje **0,14 m³**

Pezzi per scatola / Pieces for box / Pièces par carton / Stücke in einem Karton / Piezas por caja **2**

AC

- > Finiture telaio (vedi p. 397)
- > Frame finishes (see p. 397)
- > Finitions piètement (voir p. 397)
- > Gestell Fertigungen (sehen S. 397)
- > Acabados estructura (ver p. 397)

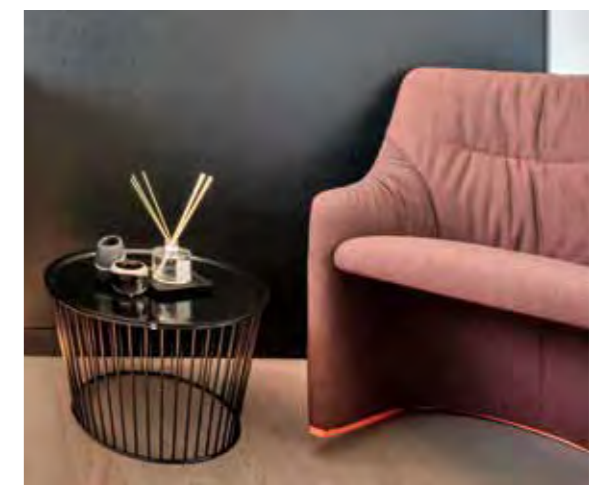

# salinero

design  
Giulio lacchetti

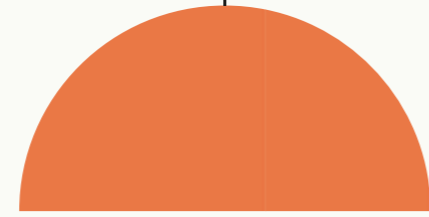

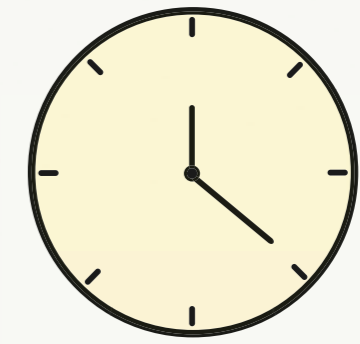
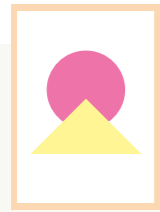



- > Finiture telaio
- > Frame finishes
- > Finitions piètement
- > Gestell Fertigungen
- > Acabados estructura

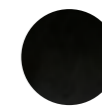

- > Finiture piani tavoli
- > Table tops finishes
- > Finitions plateaux de table
- > Tischplattenfertigungen
- > Acabados por sobres de mesas

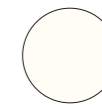

Full color

- Antimpronta /
- Anti-fingerprints /
- Anti-empreinte /
- Anti Fingerabdrücke /
- Antihuella /

Fenix  
NTM 0720  
NERO INGOGrafite /  
Graphite /  
Graphite /  
GrafitoAccessori / Accessories /  
Accessoires / Zubehoer /  
Accesorios

- > vedi p. 316
- > see p. 316
- > voir p. 316
- > sehen S. 316
- > ver p. 316



1000

- > Tavolo con gambe in tubo acciaio e piano 100x100 in stratificato HPL. Gambe a filo piano.
- > Table with 4 steel legs and 100x100 HPL solid laminate top. Top's edge legs.
- > Table avec 4 pieds en acier et plateau 100x100 en stratifié HPL. Piètement à fleur du plateau.
- > Tisch mit 4-beinigem Stahlgestell und 100x100 HPL Compactplatte. Tischbeine sind bündig zur Tischplatte.
- > Pie de mesa 4 patas en acero y sobre 100x100 en estratificado HPL. Patas a ras del sobre.

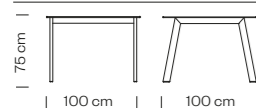
Peso / Weight /  
Poids / Gewicht / Peso  
**31,5 kg**Imballo / Packaging /  
Emballage / Verpackung /  
Embalaje  
**0,09+0,17 m³**Pezzi per scatola /  
Pieces per box /  
Pièces par carton /  
Stücke in einem Karton /  
Piezas por caja  
**1**

1002

- > Tavolo con gambe in tubo acciaio e piano 240x100 in stratificato HPL. Gambe a filo piano.
- > Table with 4 steel legs and 240x100 HPL solid laminate top. Top's edge legs.
- > Table avec 4 pieds en acier et plateau 240x100 en stratifié HPL. Piètement à fleur du plateau.
- > Tisch mit 4-beinigem Stahlgestell und 240x100 HPL Compactplatte. Tischbeine sind bündig zur Tischplatte.
- > Pie de mesa 4 patas en acero y sobre 240x100 en estratificado HPL. Patas a ras del sobre.

Peso / Weight /  
Poids / Gewicht / Peso  
**56,7 kg**Imballo / Packaging /  
Emballage / Verpackung /  
Embalaje  
**0,09+0,43 m³**Pezzi per scatola /  
Pieces per box /  
Pièces par carton /  
Stücke in einem Karton /  
Piezas por caja  
**1**

1001

- > Tavolo con gambe in tubo acciaio e piano 200x100 in stratificato HPL. Gambe a filo piano.
- > Table with 4 steel legs and 200x100 HPL solid laminate top. Top's edge legs.
- > Table avec 4 pieds en acier et plateau 200x100 en stratifié HPL. Piètement à fleur du plateau.
- > Tisch mit 4-beinigem Stahlgestell und 200x100 HPL Compactplatte. Tischbeine sind bündig zur Tischplatte.
- > Pie de mesa 4 patas en acero y sobre 200x100 en estratificado HPL. Patas a ras del sobre.

Peso / Weight /  
Poids / Gewicht / Peso  
**49,5 kg**Imballo / Packaging /  
Emballage / Verpackung /  
Embalaje  
**0,09+0,34 m³**Pezzi per scatola /  
Pieces per box /  
Pièces par carton /  
Stücke in einem Karton /  
Piezas por caja  
**1**

1003

- > Tavolo con gambe in tubo acciaio e piano 300x100 in stratificato HPL. Gambe a filo piano.
- > Table with 4 steel legs and 300x100 HPL solid laminate top. Top's edge legs.
- > Table avec 4 pieds en acier et plateau 300x100 en stratifié HPL. Piètement à fleur du plateau.
- > Tisch mit 4-beinigem Stahlgestell und 300x100 HPL Compactplatte. Tischbeine sind bündig zur Tischplatte.
- > Pie de mesa 4 patas en acero y sobre 300x100 en estratificado HPL. Patas a ras del sobre.

Peso / Weight /  
Poids / Gewicht / Peso  
**68,2 kg**Imballo / Packaging /  
Emballage / Verpackung /  
Embalaje  
**0,09+0,53 m³**Pezzi per scatola /  
Pieces per box /  
Pièces par carton /  
Stücke in einem Karton /  
Piezas por caja  
**1**

1004

- > Tavolo con gambe in tubo acciaio e piano 260x100 in stratificato HPL. Gambe posizionate internamente al piano.
- > Table with 4 steel legs and 260x100 HPL solid laminate top. Recessed legs.
- > Table avec 4 pieds en acier et plateau 260x100 en stratifié HPL. Piètement positionné sous le plateau.
- > Tisch mit 4-beinigem Stahlgestell und 260x100 HPL Compactplatte. Tischplatte aussen bündig zu den Tischbeinen.
- > Pie de mesa 4 patas en acero y sobre 260x100 en estratificado HPL. Patas por dentro del sobre.

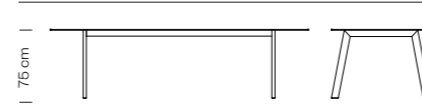
Peso / Weight /  
Poids / Gewicht / Peso  
**58,1 kg**Imballo / Packaging /  
Emballage / Verpackung /  
Embalaje  
**0,09+0,46 m³**Pezzi per scatola /  
Pieces per box /  
Pièces par carton /  
Stücke in einem Karton /  
Piezas por caja  
**1**

1005

- > Tavolo con gambe in tubo acciaio e piano 300x100 in stratificato HPL. Gambe posizionate internamente al piano.
- > Table with 4 steel legs and 300x100 HPL solid laminate top. Recessed legs.
- > Table avec 4 pieds en acier et plateau 300x100 en stratifié HPL. Piètement positionné sous le plateau.
- > Tisch mit 4-beinigem Stahlgestell und 300x100 HPL Compactplatte. Tischplatte aussen bündig zu den Tischbeinen.
- > Pie de mesa 4 patas en acero y sobre 300x100 en estratificado HPL. Patas por dentro del sobre.

Peso / Weight /  
Poids / Gewicht / Peso  
**66,7 kg**Imballo / Packaging /  
Emballage / Verpackung /  
Embalaje  
**0,09+0,53 m³**Pezzi per scatola /  
Pieces per box /  
Pièces par carton /  
Stücke in einem Karton /  
Piezas por caja  
**1**

# dalton

design  
Giulio Iacchetti

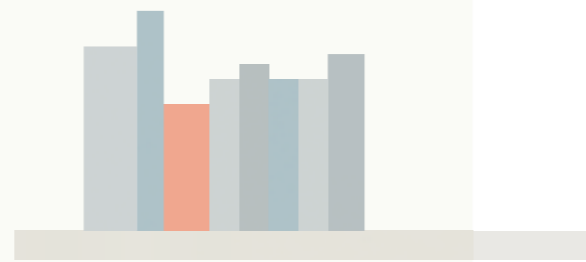





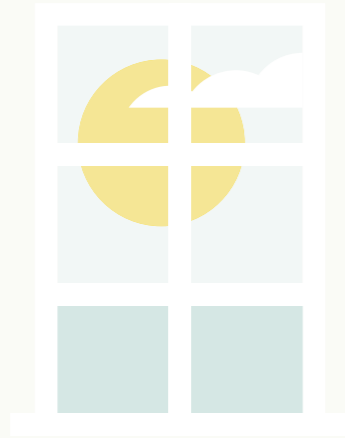

## 614

- > Tavolo con fusto in frassino e piano in stratificato HPL.
- > Table with ash wood frame and HPL solid laminate top.
- > Table avec chassis en frêne et plateau en stratifié HPL.
- > Tisch mit Gestell aus Esche und HPL Compactplatte.
- > Mesa con estructura en madera de fresno y sobre en estratificado HPL.

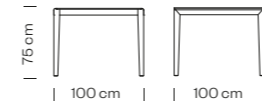

Peso / Weight / Poids / Gewicht / Peso  
**31 kg**

Imballo / Packaging / Emballage / Verpackung / Embalaje  
**0,14+0,014 m³**

Pezzi per scatola / Pieces per box / Pièces par carton / Stücke in einem Karton / Piezas por caja  
**1**



## 615

- > Tavolo con fusto in frassino e piano in stratificato HPL.
- > Table with ash wood frame and HPL solid laminate top.
- > Table avec chassis en frêne et plateau en stratifié HPL.
- > Tisch mit Gestell aus Esche und HPL Compactplatte.
- > Mesa con estructura en madera de fresno y sobre en estratificado HPL.



Peso / Weight / Poids / Gewicht / Peso  
**49,3 kg**

Imballo / Packaging / Emballage / Verpackung / Embalaje  
**0,14+0,27 m³**

Pezzi per scatola / Pieces per box / Pièces par carton / Stücke in einem Karton / Piezas por caja  
**1**



## 616

- > Tavolo con fusto in frassino e piano in stratificato HPL.
- > Table with ash wood frame and HPL solid laminate top.
- > Table avec chassis en frêne et plateau en stratifié HPL.
- > Tisch mit Gestell aus Esche und HPL Compactplatte.
- > Mesa con estructura en madera de fresno y sobre en estratificado HPL.



Peso / Weight / Poids / Gewicht / Peso  
**56,3 kg**

Imballo / Packaging / Emballage / Verpackung / Embalaje  
**0,14+0,033 m³**

Pezzi per scatola / Pieces per box / Pièces par carton / Stücke in einem Karton / Piezas por caja  
**1**



## 617

- > Tavolo con fusto in frassino e piano in stratificato HPL.
- > Table with ash wood frame and HPL solid laminate top.
- > Table avec chassis en frêne et plateau en stratifié HPL.
- > Tisch mit Gestell aus Esche und HPL Compactplatte.
- > Mesa con estructura en madera de fresno y sobre en estratificado HPL.



Peso / Weight / Poids / Gewicht / Peso  
**66,8 kg**

Imballo / Packaging / Emballage / Verpackung / Embalaje  
**0,14+0,41 m³**

Pezzi per scatola / Pieces per box / Pièces par carton / Stücke in einem Karton / Piezas por caja  
**1**

## LE

- > Finiture telaio
- > Frame finishes
- > Finitions piètement
- > Gestell Fertigungen
- > Acabados estructura



## STR

- > Finiture piani tavoli
- > Table tops finishes
- > Finitions plateaux de table
- > Tischplattenfertigungen
- > Acabados por sobres de mesas

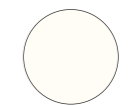

Full color

- Antimpronta / Anti-fingerprints / Anti-empreinte / Anti Fingerabdrücke / Antihuella /



Fenix  
NTM 0720  
NERO INGO

Grafite / Graphite / Graphite / Grafito

Accessori / Accessories / Accessoires / Zubehoer / Accesorios

- > vedi p. 316
- > see p. 316
- > voir p. 316
- > sehen S. 316
- > ver p. 316

# accessori / accessories / accessoires / zubehoer / accessorios

per / for /  
pour / für / por  
salinero, dalton



## A

- > Dispositivo di alimentazione. Presa elettrica e USB.
- > Power supply device. Electric socket and USB.
- > Système d'alimentation. Prise électrique et USB.
- > Integrierte Steckdose/USB.
- > Dispositivo de suministro de energía. Toma de corriente y USB.

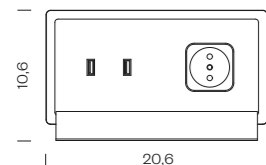

316

## B

- > Dispositivo di ricarica wireless a scomparsa per smartphone dotati di ricevitore Qi o con opportuno adattatore o cover o pellicola per batteria.
- > Retractable wireless charging device for smartphones equipped with Qi wireless receiver or with appropriate adapter or cover or film for battery.
- > Chargeur rétractable sans fil pour mobiles multifonction équipés d'un récepteur Qi ou avec un adaptateur ou un cache approprié ou un film pour batterie.
- > Integriertes, drahtloses Ladegerät für Smartphones, die mit einem Qi-Empfänger, einem geeigneten Adapter oder einer entsprechenden Abdeckung oder Folie für den Akku ausgestattet sind.
- > Dispositivo de carga sin hilos retráctil para teléfonos inteligentes equipados con receptor Qi ó con el adaptador ó cubierta ó película adecuados para la batería.

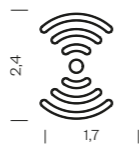

## C

- > Asola su piano con canalina raccolta cavi.
- > Buttonhole on top with cable collection channel.
- > Boucle sur plateau avec gouttière pour câble.
- > Kabelauslass Tischplatte.
- > Ojal sobre mesa con guía para contener cables.

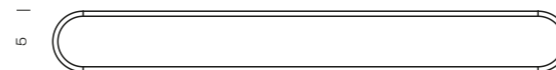

## D

- > Vertebra passacavi scrivania/pavimento.
- > Cable guide for desk/floor.
- > Goulotte passe-câbles bureau/sol.
- > Kabelspirale/Kanal.
- > Guía pasacables escritorio/suelo.

317

**Accessori / Accessories /  
Accessoires / Zubehoer /  
Accessorios**

- > I tavoli Salinero e Dalton possono essere accessoriati nel seguente modo:
- > The Salinero and Dalton tables can be equipped as follows:
- > Les tables Salinero et Dalton peuvent être équipés comme suit:
- > Die Tische Salinero und Dalton können die folgenden Zubehöre haben:
- > Las mesas Salinero y Dalton se pueden equipar según las combinaciones a continuación:

**A (+D)**

**B (+D)**

**C (+D)**

**AB (+D)**

**BC (+D)**

- > L'accessorio D può essere inserito in ogni combinazione, gli accessori A e C non sono tra loro compatibili.
- > The accessory D can be inserted in any combination. Accessories A and C are not compatible with each other.
- > L'accessoire D peut être inséré dans toutes les combinaisons, les accessoires A et C ne sont pas compatibles.
- > Das Zubehör D kann in jeder Kombination eingesetzt werden, die Zubehörteile A und C sind nicht miteinander kompatibel.
- > El accesorio D se puede insertar en todas las combinaciones, los accesorios A y C no son compatibles entre si.

**Salinero**

Combinazioni disponibili / Available combinations /  
Disponibles /  
Combinaisons disponibles /  
Verfügbare Kombination /  
Combinaciones disponibles

**1001 AB**

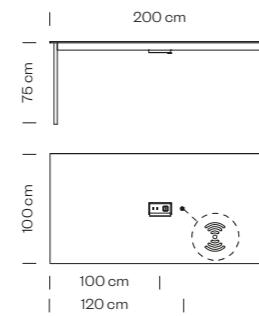

**1003 BC**

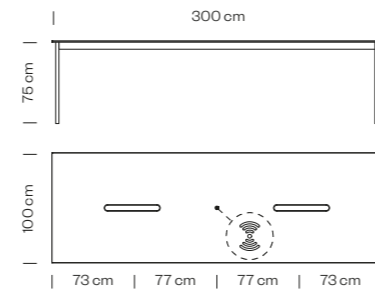

**1001 BC**

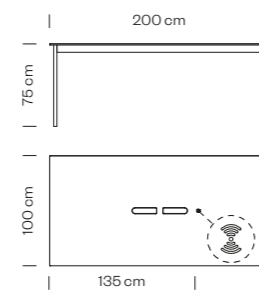

**1004 AB**

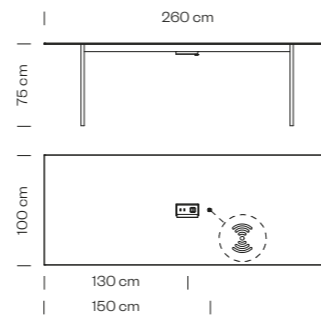

**1002 AB**

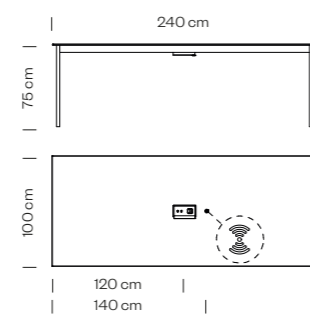

**1004 BC**

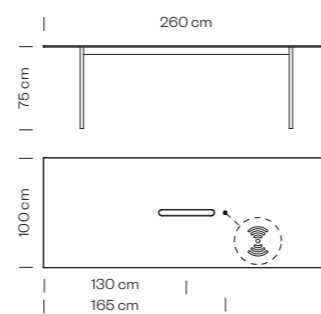

**1002 BC**

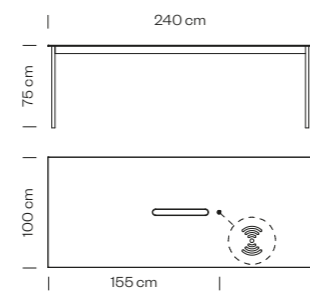

**1005 AB**

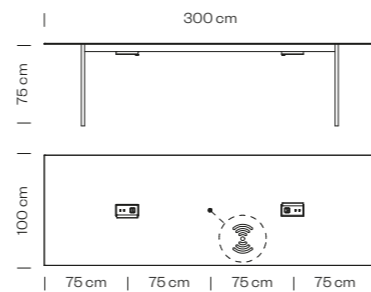

**1003 AB**

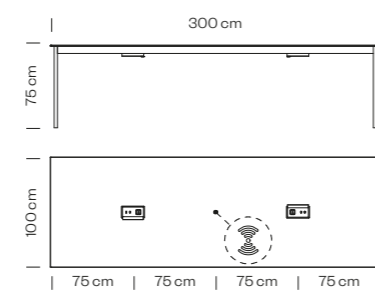

**1005 BC**

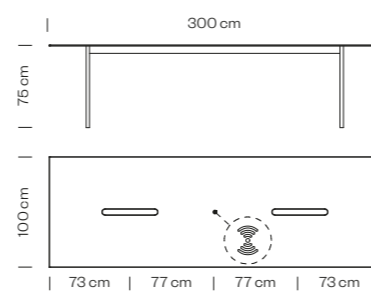

**Dalton**

Combinazioni disponibili / Available combinations /  
Disponibles /  
Combinaisons disponibles /  
Verfügbare Kombination /  
Combinaciones disponibles

**615 AB**

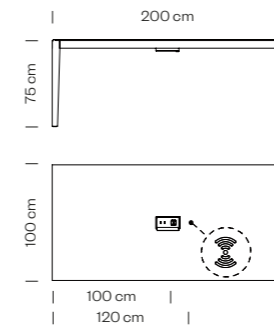

**615 BC**

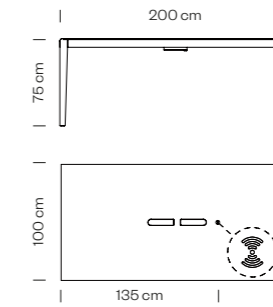

**616 AB**

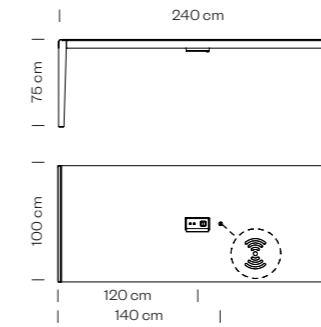

**617 AB**

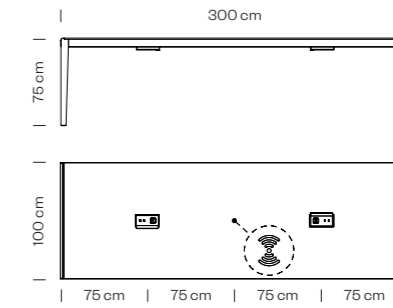

**616 BC**

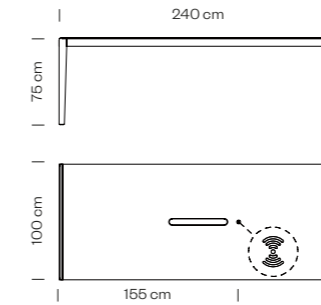

**617 BC**

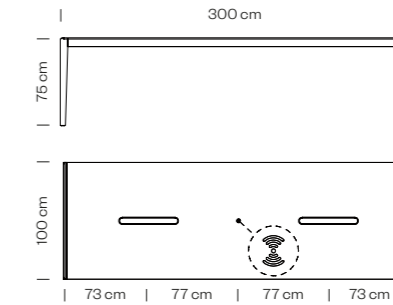



jet

design  
rdm

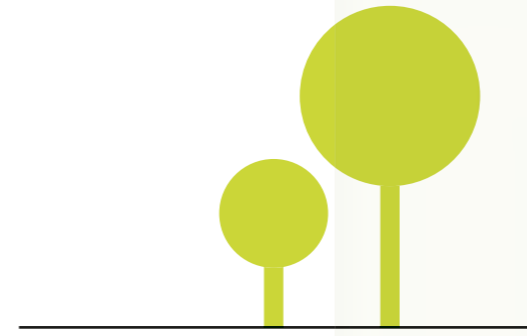



---

## AC

- > Finiture telaio (vedi p. 397)
- > Frame finishes (see p. 397)
- > Finitions piètement (voir p. 397)
- > Gestell Fertigungen (sehen S. 397)
- > Acabados estructura (ver p. 397)

---

## LE

- > Finiture telaio
- > Frame finishes
- > Finitions piètement
- > Gestell Fertigungen
- > Acabados estructura





## 521Q

- > Tavolo con telaio 4 gambe in tubo acciaio. H 35 cm.
- > Coffee table with 4 steel legs. Height 35 cm.
- > Table avec 4 pieds en acier. Hauteur 35 cm.
- > Tisch mit 4-beinigem Stahlgestell. Höhe 35 cm.
- > Pie de mesa 4 patas en acero. Altura 35 cm.

Piani Tavolo / Table Tops /  
Plateaux De Table / Tischplatten /  
Sobres De Mesa  
Ø 60 cm  
60x60 cm



## 521T

- > Tavolo con telaio 3 gambe in tubo acciaio. H 35 cm.
- > Coffee table with 3 steel legs. Height 35 cm.
- > Table avec 3 pieds en acier. Hauteur 35 cm.
- > Tisch mit 3-beinigem Stahlgestell. Höhe 35 cm.
- > Pie de mesa 3 patas en acero. Altura 35 cm.

Piani Tavolo / Table Tops /  
Plateaux De Table / Tischplatten /  
Sobres De Mesa  
Ø 60 cm



## 522Q

- > Tavolo con telaio 4 gambe in faggio. H 35 cm.
- > Coffee table with 4 beech wood legs. Height 35 cm.
- > Table avec 4 pieds en hêtre. Hauteur 35 cm.
- > Tisch mit 4-beinigem Buchenholzgestell. Höhe 35 cm.
- > Pie de mesa 4 patas en madera de haya. Altura 35 cm.

Piani Tavolo / Table Tops /  
Plateaux De Table / Tischplatten /  
Sobres De Mesa  
Ø 60 cm  
60x60 cm



## 522T

- > Tavolo con telaio 3 gambe in faggio. H 35 cm.
- > Coffee table with 3 beech wood legs. Height 35 cm.
- > Table avec 3 pieds en hêtre. Hauteur 35 cm.
- > Tisch mit 3-beinigem Buchenholzgestell. Höhe 35 cm.
- > Pie de mesa 3 patas en madera de haya. Altura 35 cm.

Piani Tavolo / Table Tops /  
Plateaux De Table / Tischplatten /  
Sobres De Mesa  
Ø 60 cm



## 523Q

- > Tavolo con telaio 4 gambe in tubo acciaio. H 50 cm.
- > Coffee table with 4 steel legs. Height 50 cm.
- > Table avec 4 pieds en acier. Hauteur 50 cm.
- > Tisch mit 4-beinigem Stahlgestell. Höhe 50 cm.
- > Pie de mesa 4 patas en acero. Altura 50 cm.

Piani Tavolo / Table Tops /  
Plateaux De Table / Tischplatten /  
Sobres De Mesa  
Ø 60 cm  
60x60 cm



## 524Q

- > Tavolo con telaio 4 gambe in faggio. H 50 cm.
- > Coffee table with 4 beech wood legs. Height 50 cm.
- > Table avec 4 pieds en hêtre. Hauteur 50 cm.
- > Tisch mit 4-beinigem Buchenholzgestell. Höhe 50 cm.
- > Pie de mesa 4 patas en madera de haya. Altura 50 cm.

Piani Tavolo / Table Tops /  
Plateaux De Table / Tischplatten /  
Sobres De Mesa  
Ø 60 cm  
60x60 cm



## 525Q

- > Tavolo con telaio 4 gambe in tubo acciaio. H 72 cm.
- > Coffee table with 4 steel legs. Height 72 cm.
- > Table avec 4 pieds en acier. Hauteur 72 cm.
- > Tisch mit 4-beinigem Stahlgestell. Höhe 72 cm.
- > Pie de mesa 4 patas en acero. Altura 72 cm.

Piani Tavolo / Table Tops /  
Plateaux De Table / Tischplatten /  
Sobres De Mesa  
Ø 60 cm  
60x60 cm  
Ø 70 cm  
70x70 cm



## 526Q

- > Tavolo con telaio 4 gambe in tubo faggio. H 72 cm.
- > Coffee table with 4 beech wood legs. Height 72 cm.
- > Table avec 4 pieds en hêtre. Hauteur 72 cm.
- > Tisch mit 4-beinigem Buchenholzgestell. Höhe 72 cm.
- > Pie de mesa 4 patas en madera de haya. Altura 72 cm.

Piani Tavolo / Table Tops /  
Plateaux De Table / Tischplatten /  
Sobres De Mesa  
Ø 60 cm  
60x60 cm  
Ø 70 cm  
70x70 cm

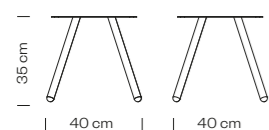

Peso / Weight /  
Poids / Gewicht / Peso **4,2 kg**

Imballo / Packaging /  
Emballage / Verpackung /  
Embalaje **0,22 m³**

Pezzi per scatola /  
Pieces per box /  
Pièces par carton /  
Stücke in einem Karton /  
Piezas por caja **2**

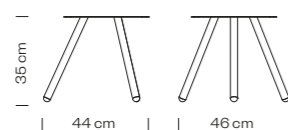

Peso / Weight /  
Poids / Gewicht / Peso **3,9 kg**

Imballo / Packaging /  
Emballage / Verpackung /  
Embalaje **0,22 m³**

Pezzi per scatola /  
Pieces per box /  
Pièces par carton /  
Stücke in einem Karton /  
Piezas por caja **2**

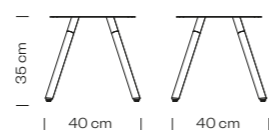

Peso / Weight /  
Poids / Gewicht / Peso **3,7 kg**

Imballo / Packaging /  
Emballage / Verpackung /  
Embalaje **0,22 m³**

Pezzi per scatola /  
Pieces per box /  
Pièces par carton /  
Stücke in einem Karton /  
Piezas por caja **2**

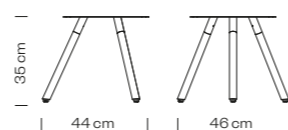

Peso / Weight /  
Poids / Gewicht / Peso **3,5 kg**

Imballo / Packaging /  
Emballage / Verpackung /  
Embalaje **0,22 m³**

Pezzi per scatola /  
Pieces per box /  
Pièces par carton /  
Stücke in einem Karton /  
Piezas por caja **2**

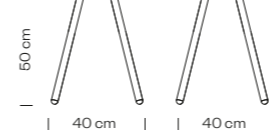

Peso / Weight /  
Poids / Gewicht / Peso **5,2 kg**

Imballo / Packaging /  
Emballage / Verpackung /  
Embalaje **0,29 m³**

Pezzi per scatola /  
Pieces per box /  
Pièces par carton /  
Stücke in einem Karton /  
Piezas por caja **2**



Peso / Weight /  
Poids / Gewicht / Peso **5,1 kg**

Imballo / Packaging /  
Emballage / Verpackung /  
Embalaje **0,29 m³**

Pezzi per scatola /  
Pieces per box /  
Pièces par carton /  
Stücke in einem Karton /  
Piezas por caja **2**



Peso / Weight /  
Poids / Gewicht / Peso **6,6 kg**

Imballo / Packaging /  
Emballage / Verpackung /  
Embalaje **0,20 m³**

Pezzi per scatola /  
Pieces per box /  
Pièces par carton /  
Stücke in einem Karton /  
Piezas por caja **2**



Peso / Weight /  
Poids / Gewicht / Peso **5,7 kg**

Imballo / Packaging /  
Emballage / Verpackung /  
Embalaje **0,20 m³**

Pezzi per scatola /  
Pieces per box /  
Pièces par carton /  
Stücke in einem Karton /  
Piezas por caja **2**



ex

design  
rdm



517

- > Tavolo con basamento in lamiera acciaio stampata, colonna in tubo alluminio.
- > Table frame with moulded steel base and aluminium column.
- > Pied de table avec embase en tôle moulée, colonne en aluminium.
- > Gestell mit Säule aus extrudiertem Aluminium und gepresster Bodenplatte aus Stahl.
- > Pie de mesa con base en plancha de acero moldeada, columna en aluminio.

Piani Tavolo / Table Tops /  
Plateaux De Table / Tischplatten /  
Sobres De Mesa  
Ø 60 cm  
Ø 70 cm  
60x60 cm  
70x70 cm

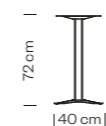

Peso / Weight /  
Poids / Gewicht / Peso **9,6 kg**

Imballo / Packaging /  
Emballage / Verpackung /  
Embalaje **0,06 m³**

Pezzi per scatola /  
Pieces per box /  
Pièces par carton /  
Stücke in einem Karton /  
Piezas por caja **2**



517R

- > Tavolo con basamento in lamiera acciaio stampata, colonna in tubo alluminio e piano ribaltabile.
- > Folding table frame with moulded steel base and aluminium column.
- > Pied de table avec embase en tôle moulée, colonne en aluminium et système de plateau rabattable.
- > Gestell mit Säule aus extrudiertem Aluminium, gepresster Bodenplatte aus Stahl und Klappbarsystem.
- > Pie de mesa con base en plancha de acero moldeada, columna en aluminio y sobre abatible.

Piani Tavolo / Table Tops /  
Plateaux De Table / Tischplatten /  
Sobres De Mesa  
Ø 60 cm  
Ø 70 cm  
60x60 cm  
70x70 cm

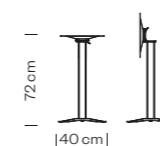

Peso / Weight /  
Poids / Gewicht / Peso **9,5 kg**

Imballo / Packaging /  
Emballage / Verpackung /  
Embalaje **0,06 m³**

Pezzi per scatola /  
Pieces per box /  
Pièces par carton /  
Stücke in einem Karton /  
Piezas por caja **2**



**Accessori / Accessories /  
Accessoires / Zubehoer /  
Accesorios**

Versione per esterno /  
Outdoor version /  
Version pour extérieur /  
Ausführung für den Außenbereich /  
Version para exteriores

AC

- > Finiture telaio (vedi p. 397)
- > Frame finishes (see p. 397)
- > Finitions piètement (voir p. 397)
- > Gestell Fertigungen (sehen S. 397)
- > Acabados estructura (ver p. 397)

AL VR

- > Finiture telaio (vedi p. 400)
- > Frame finishes (see p. 400)
- > Finitions piètement (voir p. 400)
- > Gestell Fertigungen (sehen S. 400)
- > Acabados estructura (ver p. 400)

- > Jet H72cm fusto tavolo maggiorato disponibile per piani misura 80x80 / 110x110 - D.100 / D.120 - 80x120 / 80x140 per info e prezzi rivolgersi al nostro ufficio commerciale
- > Jet H72 cm oversized table frame available for tops size 80x80 / 110x110 - D.100 / D.120 - 80x120 / 80x140 for info and prices please contact our sales department
- > Jet H72 cm pietement de table plus grand est disponible pour plateaux de dimensions 80x80 / 110x110 - D.100 / D.120 - 80x120 / 80x140 pour infos et tarifs contacter notre service commercial
- > Jet H72 cm Tischgestell mit erhöhter Grose verfügbar für Platten 80x80 / 110x110 - D.100 / D.120 - 80x120 / 80x140 für Informationen und Preise kontaktieren Sie bitte unser Verkaufsbüro
- > Jet H72 cm pie de mesa mas grande disponible para sobres de 80x80 / 110x110 - D.100 / D.120 - 80x120 / 80x140 para informacion y precios contactar nuestra oficina comercia

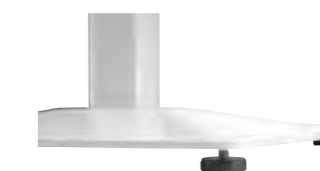

**Accessori / Accessories /  
Accessoires / Zubehoer /  
Accesorios**

Piedini Regolabili H 12 mm /  
H 12 mm adjustable feet /  
Vérins réglables H 12 mm /  
Verstellgleitern H. 12 mm /  
Pies niveladores H 12 mm

ax

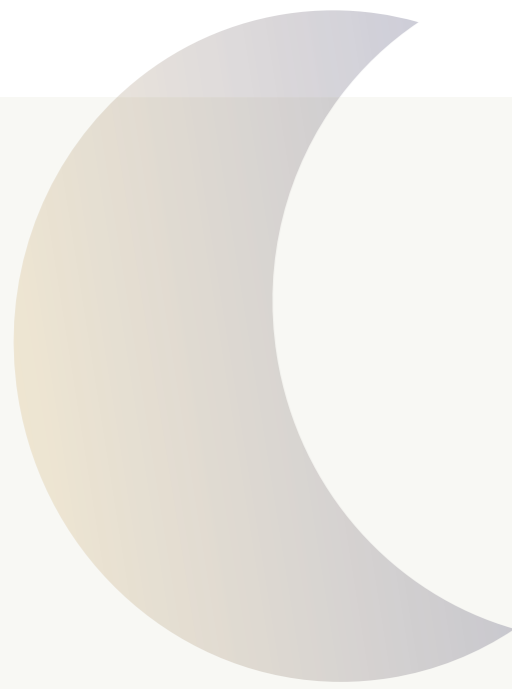

design  
rdm

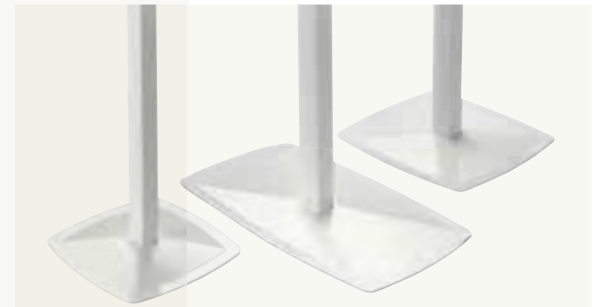
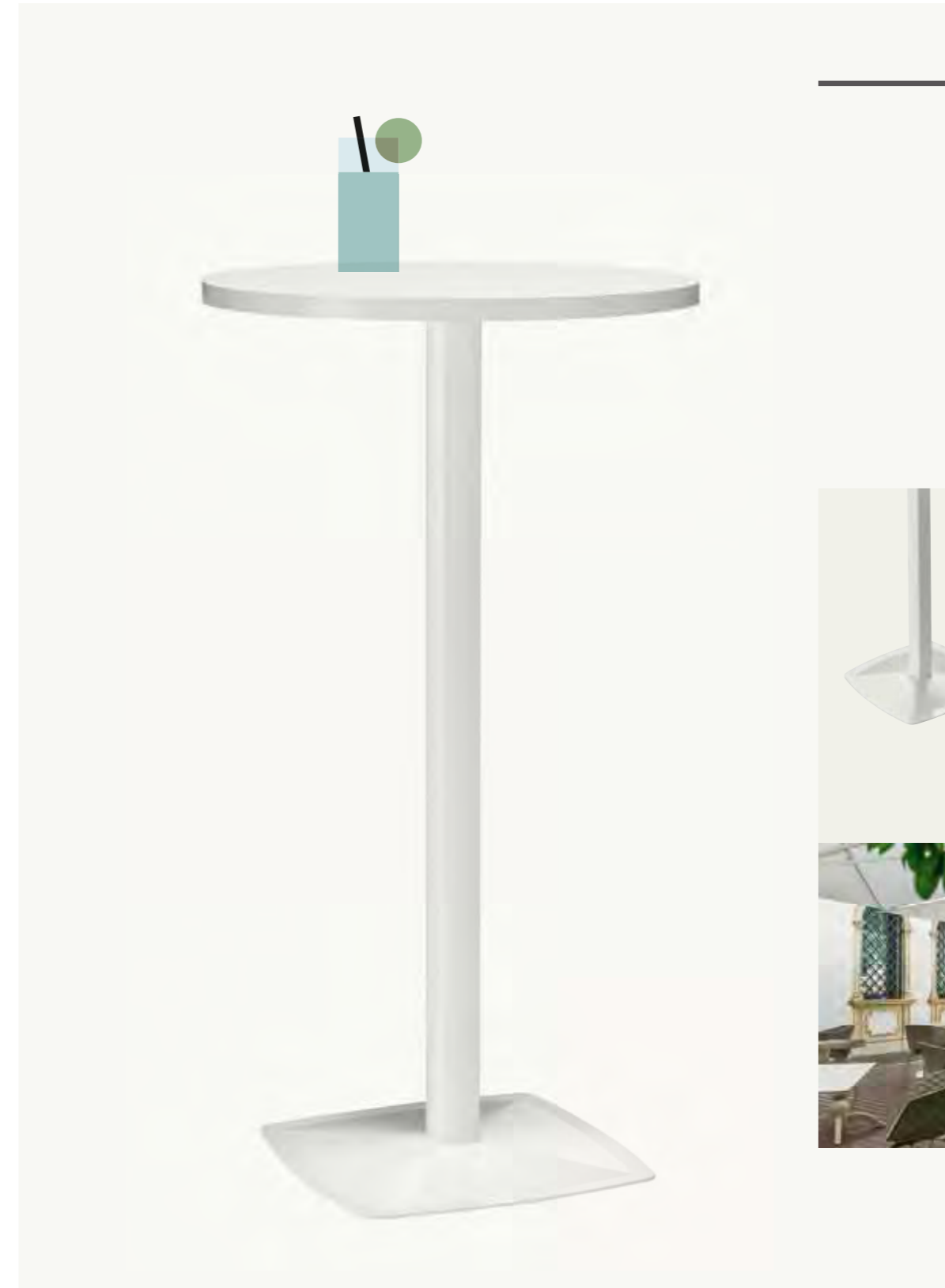



## 511

- > Tavolo con basamento in lamiera acciaio stampata, colonna in alluminio.
- > Table frame with moulded steel base and aluminium column.
- > Châssis avec embase en acier moulé et colonne en aluminium.
- > Tischgestell mit Säule aus extrudiertem Aluminium und gepresster Bodenplatte aus Stahl.
- > Pie de mesa con base en plancha de acero moldeada, columna en aluminio.

Piani Tavolo / Table Tops /  
Plateaux De Table / Tischplatten /  
Sobres De Mesa  
Ø 60 cm  
Ø 70 cm  
Ø 80 cm  
Ø 90 cm  
Ø 100 cm  
60x60 cm  
70x70 cm  
80x80 cm



## 511A

- > Tavolo alto con basamento in lamiera acciaio stampata, colonna in alluminio.
- > High table frame with moulded steel base and aluminium column.
- > Châssis avec embase en acier moulé et colonne en aluminium, version mange debout.
- > Stehtischgestell mit Säule aus extrudiertem Aluminium und gepresster Bodenplatte aus Stahl.
- > Pie de mesa con base en plancha de acero moldeada, columna en aluminio. Mesa alta.

Piani Tavolo / Table Tops /  
Plateaux De Table / Tischplatten /  
Sobres De Mesa  
Ø 60 cm  
Ø 70 cm  
60x60 cm  
70x70 cm



## 512

- > Tavolo con basamento in lamiera acciaio stampata, colonna in alluminio.
- > Table frame with moulded steel base and aluminium column.
- > Châssis avec embase en acier moulé et colonne en aluminium.
- > Tischgestell mit Säule aus extrudiertem Aluminium und gepresster Bodenplatte aus Stahl.
- > Pie de mesa con base en plancha de acero moldeada, columna en aluminio.

Piani Tavolo / Table Tops /  
Plateaux De Table / Tischplatten /  
Sobres De Mesa  
Ø 100 cm  
Ø 110 cm  
80x80 cm  
90x90 cm



## 512A

- > Tavolo alto con basamento in lamiera acciaio stampata, colonna in alluminio.
- > High table frame with moulded steel base and aluminium column.
- > Châssis avec embase en acier moulé et colonne en aluminium, version mange debout.
- > Stehtischgestell mit Säule aus extrudiertem Aluminium und gepresster Bodenplatte aus Stahl.
- > Pie de mesa con base en plancha de acero moldeada, columna en aluminio. Mesa alta.

Piani Tavolo / Table Tops /  
Plateaux De Table / Tischplatten /  
Sobres De Mesa  
Ø 80 cm  
80x80 cm



## 513

- > Tavolo con basamento in lamiera acciaio stampata, colonna in alluminio.
- > Table frame with moulded steel base and aluminium column.
- > Châssis avec embase en acier moulé et colonne en aluminium.
- > Tischgestell mit Säule aus extrudiertem Aluminium und gepresster Bodenplatte aus Stahl.
- > Pie de mesa con base en plancha de acero moldeada, columna en aluminio.

Piani Tavolo / Table Tops /  
Plateaux De Table / Tischplatten /  
Sobres De Mesa  
Ø 120 cm  
Ø 130 cm  
Ø 140 cm  
Ø 150 cm  
100x100 cm  
110x110 cm



## 514

- > Tavolo con basamento in lamiera acciaio stampata, colonna in alluminio.
- > Table frame with moulded steel base and aluminium column.
- > Châssis avec embase en acier moulé et colonne en aluminium.
- > Tischgestell mit Säule aus extrudiertem Aluminium und gepresster Bodenplatte aus Stahl.
- > Pie de mesa con base en plancha de acero moldeada, columna en aluminio.

Piani Tavolo / Table Tops /  
Plateaux De Table / Tischplatten /  
Sobres De Mesa  
60x100 cm  
60x110 cm  
60x120 cm  
70x110 cm  
70x120 cm  
70x130 cm  
80x120 cm  
80x130 cm  
80x140 cm



## AC

### Accessori / Accessories / Accessoires / Zubehoer / Accesorios

Versione per esterno /  
Outdoor version /  
Version pour extérieur /  
Ausführung für den Außenbereich /  
Version para exteriores

- > Finiture telaio (vedi p. 397)
- > Frame finishes (see p. 397)
- > Finitions piètement (voir p. 397)
- > Gestell Fertigungen (sehen S. 397)
- > Acabados estructura (ver p. 397)



### Accessori / Accessories / Accessoires / Zubehoer / Accesorios

Piedini Regolabili H 12 mm /  
H 12 mm adjustable feet /  
Vérins réglables H 12 mm /  
Verstellgleitern H. 12 mm /  
Pies niveladores H 12 mm

## AL VR

- > Finiture telaio (vedi p. 400)
- > Frame finishes (see p. 400)
- > Finitions piètement (voir p. 400)
- > Gestell Fertigungen (sehen S. 400)
- > Acabados estructura (ver p. 400)

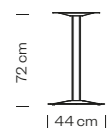

Peso / Weight /  
Poids / Gewicht / Peso **13,6 kg**

Imballo / Packaging /  
Emballage / Verpackung /  
Embalaje **0,06 m³**

Pezzi per scatola /  
Pieces per box /  
Pièces par carton /  
Stücke in einem Karton /  
Piezas por caja **2**



Peso / Weight /  
Poids / Gewicht / Peso **14,1 kg**

Imballo / Packaging /  
Emballage / Verpackung /  
Embalaje **0,06 m³**

Pezzi per scatola /  
Pieces per box /  
Pièces par carton /  
Stücke in einem Karton /  
Piezas por caja **2**

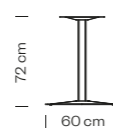

Peso / Weight /  
Poids / Gewicht / Peso **21,2 kg**

Imballo / Packaging /  
Emballage / Verpackung /  
Embalaje **0,07 m³**

Pezzi per scatola /  
Pieces per box /  
Pièces par carton /  
Stücke in einem Karton /  
Piezas por caja **1**

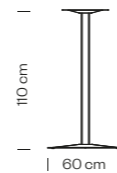

Peso / Weight /  
Poids / Gewicht / Peso **21,7 kg**

Imballo / Packaging /  
Emballage / Verpackung /  
Embalaje **0,07 m³**

Pezzi per scatola /  
Pieces per box /  
Pièces par carton /  
Stücke in einem Karton /  
Piezas por caja **1**

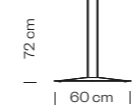

Peso / Weight /  
Poids / Gewicht / Peso **22 kg**

Imballo / Packaging /  
Emballage / Verpackung /  
Embalaje **0,07 m³**

Pezzi per scatola /  
Pieces per box /  
Pièces par carton /  
Stücke in einem Karton /  
Piezas por caja **1**

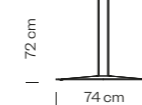

Peso / Weight /  
Poids / Gewicht / Peso **20,5 kg**

Imballo / Packaging /  
Emballage / Verpackung /  
Embalaje **0,06 m³**

Pezzi per scatola /  
Pieces per box /  
Pièces par carton /  
Stücke in einem Karton /  
Piezas por caja **1**





# deck

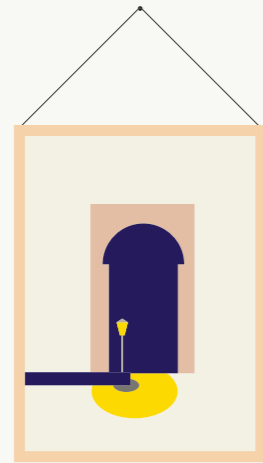

design  
rdm

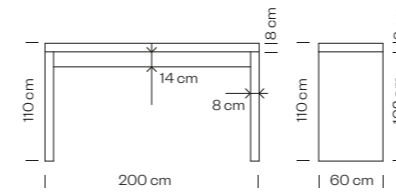

## 501A

- > Tavolo in tamburato con rivestimento in laminato. Versione prof. 60 cm.
- > Table in honeycomb board, with laminated surface. Version 60 cm depth.
- > Table mange debout en bois alvéolaire contreplaqué en stratifié. Versione profondeur 60 cm.
- > Tisch aus Holz mit Wabeneinlage und Verkleidung aus Laminat. Tiefe 60 cm.
- > Mesa en tamburado de madera con revestimiento en laminado. Profundidad 60 cm.

Peso / Weight / Poids / Gewicht / Peso **53 kg**

Imballo / Packaging / Emballage / Verpackung / Embalaje  
**0,11 m<sup>3</sup> + 0,11 m<sup>3</sup> + 0,24 m<sup>3</sup> + 0,08 m<sup>3</sup>**

Pezzi per scatola / Pieces per box / Pièces par carton / Stücke in einem Karton / Piezas por caja **1**

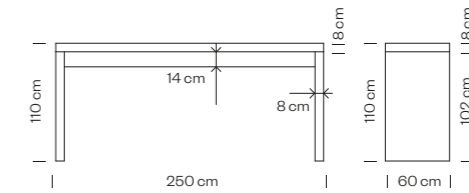

## 501B

- > Tavolo in tamburato con rivestimento in laminato. Versione prof. 60 cm.
- > Table in honeycomb board, with laminated surface. Version 60 cm depth.
- > Table mange debout en bois alvéolaire contreplaqué en stratifié. Versione profondeur 60 cm.
- > Tisch aus Holz mit Wabeneinlage und Verkleidung aus Laminat. Tiefe 60 cm.
- > Mesa en tamburado de madera con revestimiento en laminado. Profundidad 60 cm.

Peso / Weight / Poids / Gewicht / Peso **59 kg**

Imballo / Packaging / Emballage / Verpackung / Embalaje  
**0,11 m<sup>3</sup> + 0,11 m<sup>3</sup> + 0,29 m<sup>3</sup> + 0,10 m<sup>3</sup>**

Pezzi per scatola / Pieces per box / Pièces par carton / Stücke in einem Karton / Piezas por caja **1**

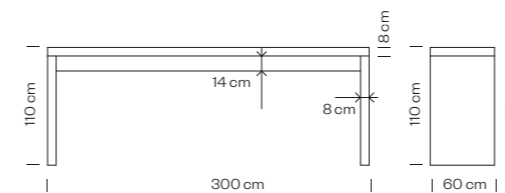

## 501C

- > Tavolo in tamburato con rivestimento in laminato. Versione prof. 60 cm.
- > Table in honeycomb board, with laminated surface. Version 60 cm depth.
- > Table mange debout en bois alvéolaire contreplaqué en stratifié. Versione profondeur 60 cm.
- > Tisch aus Holz mit Wabeneinlage und Verkleidung aus Laminat. Tiefe 60 cm.
- > Mesa en tamburado de madera con revestimiento en laminado. Profundidad 60 cm.

Peso / Weight / Poids / Gewicht / Peso **66 kg**

Imballo / Packaging / Emballage / Verpackung / Embalaje  
**0,11 m<sup>3</sup> + 0,11 m<sup>3</sup> + 0,35 m<sup>3</sup> + 0,12 m<sup>3</sup>**

Pezzi per scatola / Pieces per box / Pièces par carton / Stücke in einem Karton / Piezas por caja **1**

## LAM

- > Finiture telaio (vedi p. 408/409)
- > Frame finishes (see p. 408/409)
- > Finitions piètement (voir p. 408/409)
- > Gestell fertigungen (sehen S. 408/409)
- > Acabados estructura (ver p. 408/409)

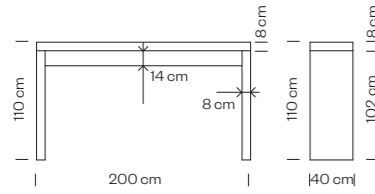

## 502A

- > Tavolo in tamburato con rivestimento in laminato. Versione prof. 40 cm.
- > Table in honeycomb board, with laminated surface. Version 40 cm depth.
- > Table mange debout en bois alvéolaire contreplaqué en stratifié. Versione profondeur 40 cm.
- > Tisch aus Holz mit Wabeneinlage und Verkleidung aus Laminat. Tiefe 40 cm.
- > Mesa en tamburado de madera con revestimiento en laminado. Profundidad 40 cm.

Peso / Weight / Poids / Gewicht / Peso **35 kg**

Imballo / Packaging / Emballage / Verpackung / Embalaje **0,08 m<sup>3</sup> + 0,08 m<sup>3</sup> + 0,18 m<sup>3</sup> + 0,08 m<sup>3</sup>**

Pezzi per scatola / Pieces per box / Pièces par carton / Stücke in einem Karton / Piezas por caja **1**

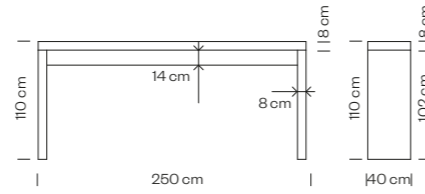

## 502B

- > Tavolo in tamburato con rivestimento in laminato. Versione prof. 40 cm.
- > Table in honeycomb board, with laminated surface. Version 40 cm depth.
- > Table mange debout en bois alvéolaire contreplaqué en stratifié. Versione profondeur 40 cm.
- > Tisch aus Holz mit Wabeneinlage und Verkleidung aus Laminat. Tiefe 40 cm.
- > Mesa en tamburado de madera con revestimiento en laminado. Profundidad 40 cm.

Peso / Weight / Poids / Gewicht / Peso **39 kg**

Imballo / Packaging / Emballage / Verpackung / Embalaje **0,08 m<sup>3</sup> + 0,08 m<sup>3</sup> + 0,21 m<sup>3</sup> + 0,10 m<sup>3</sup>**

Pezzi per scatola / Pieces per box / Pièces par carton / Stücke in einem Karton / Piezas por caja **1**

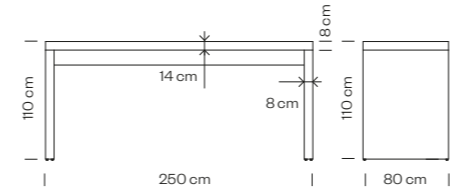

## 503B

- > Tavolo in tamburato con rivestimento in laminato. Versione prof. 80 cm.
- > Table in honeycomb board, with laminated surface. Version 80 cm depth.
- > Table mange debout en bois alvéolaire contreplaqué en stratifié. Versione profondeur 80 cm.
- > Tisch aus Holz mit Wabeneinlage und Verkleidung aus Laminat. Tiefe 80 cm.
- > Mesa en tamburado de madera con revestimiento en laminado. Profundidad 80 cm.

Peso / Weight / Poids / Gewicht / Peso **78 kg**

Imballo / Packaging / Emballage / Verpackung / Embalaje **0,15 m<sup>3</sup> + 0,15 m<sup>3</sup> + 0,44 m<sup>3</sup> + 0,10 m<sup>3</sup>**

Pezzi per scatola / Pieces per box / Pièces par carton / Stücke in einem Karton / Piezas por caja **1**

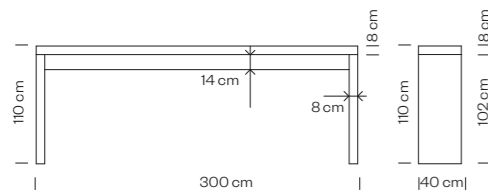

## 502C

- > Tavolo in tamburato con rivestimento in laminato. Versione prof. 40 cm.
- > Table in honeycomb board, with laminated surface. Version 40 cm depth.
- > Table mange debout en bois alvéolaire contreplaqué en stratifié. Versione profondeur 40 cm.
- > Tisch aus Holz mit Wabeneinlage und Verkleidung aus Laminat. Tiefe 40 cm.
- > Mesa en tamburado de madera con revestimiento en laminado. Profundidad 40 cm.

Peso / Weight / Poids / Gewicht / Peso **42 kg**

Imballo / Packaging / Emballage / Verpackung / Embalaje **0,08 m<sup>3</sup> + 0,08 m<sup>3</sup> + 0,25 m<sup>3</sup> + 0,12 m<sup>3</sup>**

Pezzi per scatola / Pieces per box / Pièces par carton / Stücke in einem Karton / Piezas por caja **1**

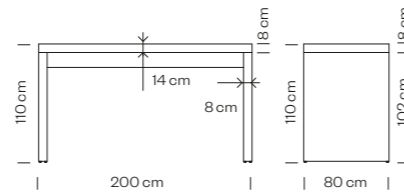

## 503A

- > Tavolo in tamburato con rivestimento in laminato. Versione prof. 80 cm.
- > Table in honeycomb board, with laminated surface. Version 80 cm depth.
- > Table mange debout en bois alvéolaire contreplaqué en stratifié. Versione profondeur 80 cm.
- > Tisch aus Holz mit Wabeneinlage und Verkleidung aus Laminat. Tiefe 80 cm.
- > Mesa en tamburado de madera con revestimiento en laminado. Profundidad 80 cm.

Peso / Weight / Poids / Gewicht / Peso **70 kg**

Imballo / Packaging / Emballage / Verpackung / Embalaje **0,15 m<sup>3</sup> + 0,15 m<sup>3</sup> + 0,31 m<sup>3</sup> + 0,08 m<sup>3</sup>**

Pezzi per scatola / Pieces per box / Pièces par carton / Stücke in einem Karton / Piezas por caja **1**

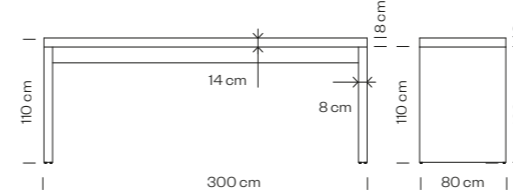

## 503C

- > Tavolo in tamburato con rivestimento in laminato. Versione prof. 80 cm.
- > Table in honeycomb board, with laminated surface. Version 80 cm depth.
- > Table mange debout en bois alvéolaire contreplaqué en stratifié. Versione profondeur 80 cm.
- > Tisch aus Holz mit Wabeneinlage und Verkleidung aus Laminat. Tiefe 80 cm.
- > Mesa en tamburado de madera con revestimiento en laminado. Profundidad 80 cm.

Peso / Weight / Poids / Gewicht / Peso **85 kg**

Imballo / Packaging / Emballage / Verpackung / Embalaje **0,15 m<sup>3</sup> + 0,15 m<sup>3</sup> + 0,44 m<sup>3</sup> + 0,12 m<sup>3</sup>**

Pezzi per scatola / Pieces per box / Pièces par carton / Stücke in einem Karton / Piezas por caja **1**





## 466

- > Tavolo con telaio in tubo acciaio, piedini regolabili.
- > Table frame in painted steel, with adjustable feet.
- > Pied de table en acier, avec vérins réglables.
- > Tisch mit Gestell aus Stahlrohren mit Verstellgleitern.
- > Pie de mesa en acero, con pies niveladores.

Piani Tavolo / Table Tops /  
Plateaux De Table / Tischplatten /  
Sobres De Mesa  
Ø 60 cm  
Ø 70 cm  
Ø 80 cm  
60x60 cm  
70x70 cm

## 466A

- > Tavolo alto con telaio in tubo acciaio, piedini regolabili.
- > High table frame in painted steel, with adjustable feet.
- > Pied mange debout en acier, avec vérins réglables.
- > Stehtisch mit Gestell aus Stahlrohren und Verstellgleitern.
- > Pie de mesa en acero, con pies niveladores. Mesa alta.

Piani Tavolo / Table Tops /  
Plateaux De Table / Tischplatten /  
Sobres De Mesa  
Ø 60 cm  
Ø 70 cm  
60x60 cm

## 467

- > Tavolo con telaio in tubo acciaio, piedini regolabili.
- > Table frame in painted steel, with adjustable feet.
- > Pied de table en acier, avec vérins réglables.
- > Tisch mit Gestell aus Stahlrohren und Verstellgleitern.
- > Pie de mesa en acero, con pies niveladores.

Piani Tavolo / Table Tops /  
Plateaux De Table / Tischplatten /  
Sobres De Mesa  
Ø 80 cm  
Ø 90 cm  
Ø 100 cm  
80x80 cm  
90x90 cm

## 467A

- > Tavolo alto con telaio in tubo acciaio, piedini regolabili.
- > High table frame in painted steel, with adjustable feet.
- > Pied mange debout en acier, avec vérins réglables.
- > Stehtisch mit Gestell aus Stahlrohren und Verstellgleitern.
- > Pie de mesa en acero, con pies niveladores. Mesa alta.

Piani Tavolo / Table Tops /  
Plateaux De Table / Tischplatten /  
Sobres De Mesa  
Ø 80 cm  
Ø 90 cm  
70x70 cm  
80x80 cm  
90x90 cm

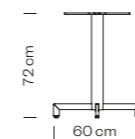

Peso / Weight /  
Poids / Gewicht / Peso **5 kg**

Imballo / Packaging /  
Emballage / Verpackung /  
Embalaje **0,09 m³**

Pezzi per scatola /  
Pieces per box /  
Pièces par carton /  
Stücke in einem Karton /  
Piezas por caja **2**

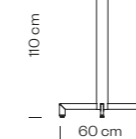

Peso / Weight /  
Poids / Gewicht / Peso **6,3 kg**

Imballo / Packaging /  
Emballage / Verpackung /  
Embalaje **0,09 m³**

Pezzi per scatola /  
Pieces per box /  
Pièces par carton /  
Stücke in einem Karton /  
Piezas por caja **1**

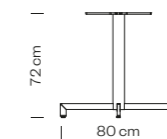

Peso / Weight /  
Poids / Gewicht / Peso **5,5 kg**

Imballo / Packaging /  
Emballage / Verpackung /  
Embalaje **0,09 m³**

Pezzi per scatola /  
Pieces per box /  
Pièces par carton /  
Stücke in einem Karton /  
Piezas por caja **2**

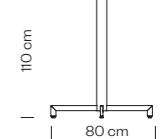

Peso / Weight /  
Poids / Gewicht / Peso **6,8 kg**

Imballo / Packaging /  
Emballage / Verpackung /  
Embalaje **0,09 m³**

Pezzi per scatola /  
Pieces per box /  
Pièces par carton /  
Stücke in einem Karton /  
Piezas por caja **1**





468

- > Tavolo con telaio in tubo acciaio, piedini regolabili.
- > Table frame in painted steel, with adjustable feet.
- > Pied de table en acier, avec vérins réglables.
- > Tisch mit Gestell aus Stahlrohren und Verstellgleitern.
- > Pie de mesa en acero, con pies niveladores.

Piani Tavolo / Table Tops /  
Plateaux De Table / Tischplatten /  
Sobres De Mesa  
Ø 100 cm  
Ø 110 cm  
Ø 120 cm  
Ø 130 cm  
100x100 cm  
110x110 cm  
120x120 cm

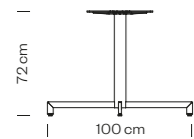

Peso / Weight /  
Poids / Gewicht / Peso **8 kg**

Imballo / Packaging /  
Emballage / Verpackung /  
Embalaje **0,12 m³**

Pezzi per scatola /  
Pieces per box /  
Pièces par carton /  
Stücke in einem Karton /  
Piezas por caja **2**



469

- > Tavolo con telaio in tubo acciaio, piedini regolabili.
- > Table frame in painted steel, with adjustable feet.
- > Pied de table en acier, avec vérins réglables.
- > Tisch mit Gestell aus Stahlrohren und Verstellgleitern.
- > Pie de mesa en acero, con pies niveladores.

Piani Tavolo / Table Tops /  
Plateaux De Table / Tischplatten /  
Sobres De Mesa  
70x110 cm  
80x120 cm  
90x130 cm

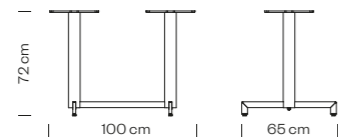

Peso / Weight /  
Poids / Gewicht / Peso **8 kg**

Imballo / Packaging /  
Emballage / Verpackung /  
Embalaje **0,12 m³**

Pezzi per scatola /  
Pieces per box /  
Pièces par carton /  
Stücke in einem Karton /  
Piezas por caja **2**

AC

- > Finiture telaio (vedi p. 397)
- > Frame finishes (see p. 397)
- > Finitions piètement (voir p. 397)
- > Gestell Fertigungen (sehen S. 397)
- > Acabados estructura (ver p. 397)



# zenith

design  
rdm



## 472Q

- > Tavolo con telaio in tubo acciaio verniciato. Piedini regolabili.
- > Table frame in painted steel, with adjustable feet.
- > Pied de table en acier verni, avec verins réglables.
- > Tisch mit Gestell aus lackierten Stahlrohren und Verstellgleitern.
- > Pie de mesa en acero barnizado, con pies niveladores.

Piani Tavolo / Table Tops /  
Plateaux De Table / Tischplatten /  
Sobres De Mesa  
69x69 cm  
80x80 cm  
90x90 cm  
100x100 cm

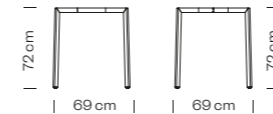

Peso / Weight /  
Poids / Gewicht / Peso **6 kg**

Imballo / Packaging /  
Emballage / Verpackung /  
Embalaje **0,30 m³**

Pezzi per scatola /  
Pieces per box /  
Pièces par carton /  
Stücke in einem Karton /  
Piezas por caja **5**



## 472R

- > Tavolo con telaio in tubo acciaio verniciato. Piedini regolabili.
- > Table frame in painted steel, with adjustable feet.
- > Pied de table en acier verni, avec verins réglables.
- > Tisch mit Gestell aus lackierten Stahlrohren und Verstellgleitern.
- > Pie de mesa en acero barnizado, con pies niveladores.

Piani Tavolo / Table Tops /  
Plateaux De Table / Tischplatten /  
Sobres De Mesa  
69x119 cm  
80x130 cm

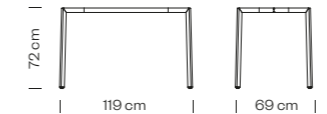

Peso / Weight /  
Poids / Gewicht / Peso **6,5 kg**

Imballo / Packaging /  
Emballage / Verpackung /  
Embalaje **0,30 m³**

Pezzi per scatola /  
Pieces per box /  
Pièces par carton /  
Stücke in einem Karton /  
Piezas por caja **5**

## AC

- > Finiture telaio (vedi p. 397)
- > Frame finishes (see p. 397)
- > Finitions piètement (voir p. 397)
- > Gestell Fertigungen (sehen S. 397)
- > Acabados estructura (ver p. 397)

- > Zenith fusto tavolo maggiorato disponibile per piani misura 90x130-90x140-100x140 / 90x180-100x180-100x200 per info e prezzi rivolgersi al nostro ufficio commerciale
- > Zenith oversized table frame available for tops size 90x130-90x140-100x140 / 90x180-100x180-100x200 for info and prices please contact our sales department
- > Zenith piètement de table plus grand est disponible pour plateaux de dimensions 90x130-90x140-100x140 / 90x180-100x180-100x200 pour infos et tarifs contacter notre service commercial
- > Zenith Tischgestell mit erhöhter Grose verfügbar für Platten 90x130-90x140-100x140 / 90x180-100x180-100x200 für Informationen und Preise kontaktieren Sie bitte unser Verkaufsbüro
- > Zenith pie de mesa mas grande disponible para sobres de 90x130-90x140-100x140 / 90x180-100x180-100x200 para informacion y precios contactar nuestra oficina comercial

mt

design  
rdm

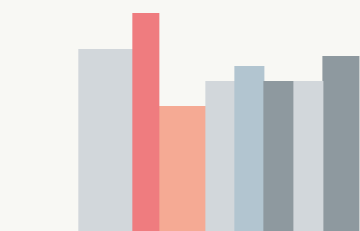

## 481

- > Tavolo con basamento in lamiera acciaio verniciata, colonna in tubo acciaio o faggio.
- > Table frame in painted steel sheet, steel or beech wood column.
- > Pied de table en acier verni, avec colonne en acier ou en hêtre.
- > Tischgestell mit lackierter Bodenplatte aus Stahl, Säule aus Stahlrohr oder Buchenrohr.
- > Pie de mesa con base en plancha de acero barnizada, columna en acero o en madera de haya.

Piani Tavolo / Table Tops /  
Plateaux De Table / Tischplatten /  
Sobres De Mesa  
Ø 60 cm  
Ø 70 cm  
60x60 cm  
70x70 cm

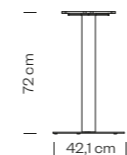

Peso / Weight /  
Poids / Gewicht / Peso **11,1 kg**

Imballo / Packaging /  
Emballage / Verpackung /  
Embalaje **0,06 m³**

Pezzi per scatola /  
Pieces per box /  
Pièces par carton /  
Stücke in einem Karton /  
Piezas por caja **2**

## 481A

- > Tavolo alto con basamento in lamiera acciaio verniciata, colonna in tubo acciaio o faggio.
- > High table frame in painted steel sheet, steel or beech wood column.
- > Pied mange debout en acier verni, avec colonne en acier ou en hêtre.
- > Stehtischgestell mit lackierter Bodenplatte aus Stahl, Säule aus Stahlrohr oder Buchenrohr.
- > Pie de mesa con base en plancha de acero barnizada, columna en acero o en madera de haya. Mesa alta.

Piani Tavolo / Table Tops /  
Plateaux De Table / Tischplatten /  
Sobres De Mesa  
Ø 60 cm  
Ø 70 cm  
60x60 cm



Peso / Weight /  
Poids / Gewicht / Peso **12,3 kg**

Imballo / Packaging /  
Emballage / Verpackung /  
Embalaje **0,06 m³**

Pezzi per scatola /  
Pieces per box /  
Pièces par carton /  
Stücke in einem Karton /  
Piezas por caja **2**

## 481A F

- > Tavolo alto con basamento in lamiera acciaio verniciata, colonna in tubo acciaio. Fissaggio a terra.
- > High table frame in painted steel sheet and steel column. Floor fixing.
- > Pied mange debout en acier verni, avec colonne en acier, pour fixation au sol.
- > Stehtischgestell mit lackierter Bodenplatte aus Stahl, Säule aus Stahlrohr oder Buchenrohr. Bodemontage.
- > Pie de mesa con base en plancha de acero barnizada para fijar al suelo, columna en acero. Mesa alta.

Piani Tavolo / Table Tops /  
Plateaux De Table / Tischplatten /  
Sobres De Mesa  
Ø 60 cm  
Ø 70 cm  
60x60 cm  
70x70 cm

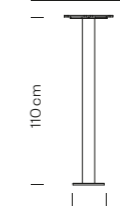

Peso / Weight /  
Poids / Gewicht / Peso **9,8 kg**

Imballo / Packaging /  
Emballage / Verpackung /  
Embalaje **0,06 m³**

Pezzi per scatola /  
Pieces per box /  
Pièces par carton /  
Stücke in einem Karton /  
Piezas por caja **2**

## 481F

- > Tavolo con basamento in lamiera acciaio verniciata, colonna in tubo acciaio. Fissaggio a terra.
- > Table frame in painted steel sheet and steel column. Floor fixing.
- > Pied de table en acier verni, avec colonne en acier, pour fixation au sol.
- > Tischgestell mit lackierter Bodenplatte aus Stahl, Säule aus Stahlrohr. Bodemontage.
- > Pie de mesa con base en plancha de acero barnizada para fijar al suelo, columna en acero.

Piani Tavolo / Table Tops /  
Plateaux De Table / Tischplatten /  
Sobres De Mesa  
Ø 60 cm  
Ø 70 cm  
60x60 cm  
70x70 cm

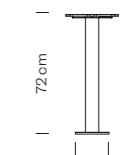

Peso / Weight /  
Poids / Gewicht / Peso **8,5 kg**

Imballo / Packaging /  
Emballage / Verpackung /  
Embalaje **0,06 m³**

Pezzi per scatola /  
Pieces per box /  
Pièces par carton /  
Stücke in einem Karton /  
Piezas por caja **2**





## 482

- > Tavolo con basamento in lamiera acciaio verniciata, colonna in tubo acciaio o faggio.
- > Table frame in painted steel sheet. Steel or beech wood column.
- > Pied de table en acier verni, avec colonne en acier ou en hêtre.
- > Tischgestell mit lackierter Bodenplatte aus Stahl, Säule aus Stahlrohr oder Buchenrohr.
- > Pie de mesa con base en plancha de acero barnizada, columna en acero o en madera de haya.

Piani Tavolo / Table Tops / Plateaux De Table / Tischplatten / Sobres De Mesa  
 Ø 80 cm  
 Ø 90 cm  
 80x80 cm  
 90x90 cm



## 482A

- > Tavolo alto con basamento in lamiera acciaio verniciata, colonna in tubo acciaio o faggio.
- > High table frame in painted steel sheet, steel or beech wood column.
- > Pied mange debout en acier verni, avec colonne en acier ou en hêtre.
- > Stehtischgestell mit lackierter Bodenplatte aus Stahl, Säule aus Stahlrohr oder Buchenrohr.
- > Pie de mesa con base en plancha de acero barnizada, columna en acero o en madera de haya. Mesa alta.

Piani Tavolo / Table Tops / Plateaux De Table / Tischplatten / Sobres De Mesa  
 Ø 80 cm  
 Ø 90 cm  
 70x70 cm



## 483

- > Tavolo con basamento in lamiera acciaio verniciata, colonna in tubo acciaio o faggio.
- > Table frame in painted steel sheet, steel or beech wood column.
- > Pied de table en acier verni, avec colonne en acier ou en hêtre.
- > Tischgestell mit lackierter Bodenplatte aus Stahl, Säule aus Stahlrohr oder Buchenrohr.
- > Pie de mesa con base en plancha de acero barnizada, columna en acero o en madera de haya.

Piani Tavolo / Table Tops / Plateaux De Table / Tischplatten / Sobres De Mesa  
 Ø 60 cm  
 Ø 70 cm  
 60x60 cm  
 70x70 cm



## 483A

- > Tavolo alto con basamento in lamiera acciaio verniciata, colonna in tubo acciaio.
- > High table frame in painted steel sheet, steel or beech wood column.
- > Pied mange debout en acier verni, avec colonne en acier.
- > Stehtischgestell mit lackierter Bodenplatte aus Stahl, Säule aus Stahlrohr.
- > Pie de mesa con base en plancha de acero barnizada, columna en acero. Mesa alta.

Piani Tavolo / Table Tops / Plateaux De Table / Tischplatten / Sobres De Mesa  
 Ø 60 cm  
 Ø 70 cm  
 60x60 cm



## 484

- > Tavolo con basamento in lamiera acciaio verniciata, colonna in tubo acciaio o faggio.
- > Table frame in painted steel. Available with steel or beech wood column.
- > Pied de table en acier verni, avec colonne en acier ou en hêtre.
- > Tischgestell mit lackierter Bodenplatte aus Stahl, Säule aus Stahlrohr oder Buchenrohr.
- > Pie de mesa con base en plancha de acero barnizada, columna en acero o en madera de haya.

Piani Tavolo / Table Tops / Plateaux De Table / Tischplatten / Sobres De Mesa  
 Ø 80 cm  
 Ø 90 cm  
 80x80 cm  
 90x90 cm



## 484A

- > Tavolo alto con basamento in lamiera acciaio verniciata, colonna in tubo acciaio.
- > High table frame in painted steel sheet, steel column.
- > Pied mange debout en acier verni, avec colonne en acier.
- > Stehtischgestell mit lackierter Bodenplatte aus Stahl, Säule aus Stahlrohr.
- > Pie de mesa con base en plancha de acero barnizada, columna en acero. Mesa alta.

Piani Tavolo / Table Tops / Plateaux De Table / Tischplatten / Sobres De Mesa  
 Ø 80 cm  
 Ø 90 cm  
 70x70 cm  
 80x80 cm



## 491Q

- > Tavolo con basamento in lamiera acciaio verniciata, colonna in tubo acciaio o faggio.
- > Table frame in painted steel sheet, steel or beech wood column.
- > Pied de table en acier verni, avec colonne en acier ou en hêtre.
- > Tischgestell mit lackierter Bodenplatte aus Stahl, Säule aus Stahlrohr oder Buchenrohr.
- > Pie de mesa con base en plancha de acero barnizada, columna en acero o en madera de haya.

Piani Tavolo / Table Tops / Plateaux De Table / Tischplatten / Sobres De Mesa  
 70x120 cm  
 70x130 cm  
 70x140 cm  
 80x120 cm  
 80x130 cm  
 80x140 cm



## 491T

- > Tavolo con basamento in lamiera acciaio verniciata, colonna in tubo acciaio o faggio.
- > Table frame in painted steel sheet, steel or beech wood column.
- > Pied de table en acier verni, avec colonne en acier ou en hêtre.
- > Tischgestell mit lackierter Bodenplatte aus Stahl, Säule aus Stahlrohr oder Buchenrohr.
- > Pie de mesa con base en plancha de acero barnizada, columna en acero o en madera de haya.

Piani Tavolo / Table Tops / Plateaux De Table / Tischplatten / Sobres De Mesa  
 70x120 cm  
 70x130 cm  
 70x140 cm  
 80x120 cm  
 80x130 cm  
 80x140 cm

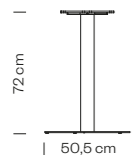

Peso / Weight / Poids / Gewicht / Peso **14,1 kg**

Imballo / Packaging / Emballage / Verpackung / Embalaje **0,06 m³**

Pezzi per scatola / Pieces per box / Pièces par carton / Stücke in einem Karton / Piezas por caja **2**



Peso / Weight / Poids / Gewicht / Peso **15,3 kg**

Imballo / Packaging / Emballage / Verpackung / Embalaje **0,07 m³**

Pezzi per scatola / Pieces per box / Pièces par carton / Stücke in einem Karton / Piezas por caja **2**



Peso / Weight / Poids / Gewicht / Peso **13,6 kg**

Imballo / Packaging / Emballage / Verpackung / Embalaje **0,06 m³**

Pezzi per scatola / Pieces per box / Pièces par carton / Stücke in einem Karton / Piezas por caja **2**



Peso / Weight / Poids / Gewicht / Peso **15,1 kg**

Imballo / Packaging / Emballage / Verpackung / Embalaje **0,06 m³**

Pezzi per scatola / Pieces per box / Pièces par carton / Stücke in einem Karton / Piezas por caja **2**

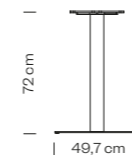

Peso / Weight / Poids / Gewicht / Peso **17,9 kg**

Imballo / Packaging / Emballage / Verpackung / Embalaje **0,07 m³**

Pezzi per scatola / Pieces per box / Pièces par carton / Stücke in einem Karton / Piezas por caja **2**



Peso / Weight / Poids / Gewicht / Peso **19,4 kg**

Imballo / Packaging / Emballage / Verpackung / Embalaje **0,07 m³**

Pezzi per scatola / Pieces per box / Pièces par carton / Stücke in einem Karton / Piezas por caja **2**

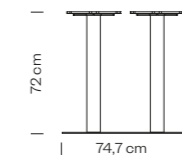

Peso / Weight / Poids / Gewicht / Peso **26,2 kg**

Imballo / Packaging / Emballage / Verpackung / Embalaje **0,06 m³**

Pezzi per scatola / Pieces per box / Pièces par carton / Stücke in einem Karton / Piezas por caja **1**

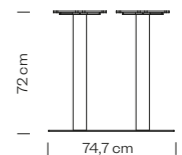

Peso / Weight / Poids / Gewicht / Peso **22,5 kg**

Imballo / Packaging / Emballage / Verpackung / Embalaje **0,06 m³**

Pezzi per scatola / Pieces per box / Pièces par carton / Stücke in einem Karton / Piezas por caja **1**



## 491A Q

- > Tavolo alto con basamento in lamiera acciaio verniciata, colonna in tubo acciaio.
- > High table frame in painted steel sheet, steel or beech wood column.
- > Pied mange debout en acier verni, avec colonne en acier.
- > Stehtischgestell mit lackierter Bodenplatte aus Stahl, Säule aus Stahlrohr.
- > Pie de mesa con base en plancha de acero barnizada, columna en acero. Mesa alta.

Piani Tavolo / Table Tops /  
Plateaux De Table / Tischplatten /  
Sobres De Mesa  
70x120 cm  
70x130 cm  
80x120 cm  
80x130 cm



## 491A T

- > Tavolo alto con basamento in lamiera acciaio verniciata, colonna in tubo acciaio o faggio.
- > High table frame in painted steel sheet, steel or beech wood column.
- > Pied mange debout en acier verni, avec colonne en acier ou en hêtre.
- > Stehtischgestell mit lackierter Bodenplatte aus Stahl, Säule aus Stahlrohr oder Buchenrohr.
- > Pie de mesa con base en plancha de acero barnizada, columna en acero o en madera de haya. Mesa alta.

Piani Tavolo / Table Tops /  
Plateaux De Table / Tischplatten /  
Sobres De Mesa  
70x120 cm  
70x130 cm  
80x120 cm  
80x130 cm



## 493

- > Tavolo con basamento in lamiera acciaio verniciata, colonna in tubo acciaio o faggio.
- > Table frame in painted steel sheet, steel or beech wood column.
- > Pied de table en acier verni, avec colonne en acier ou en hêtre.
- > Tischgestell mit lackierter Bodenplatte aus Stahl, Säule aus Stahlrohr oder Buchenrohr.
- > Pie de mesa con base en plancha de acero barnizada, columna en acero o en madera de haya.

Piani Tavolo / Table Tops /  
Plateaux De Table / Tischplatten /  
Sobres De Mesa  
Ø 110 cm  
Ø 120 cm  
Ø 130 cm  
100x100 cm  
110x110 cm



## 497

- > Tavolo con basamento in lamiera acciaio verniciata, colonna in tubo acciaio.
- > Table frame in painted steel sheet, steel column.
- > Pied de table avec embase et colonne en acier verni.
- > Tischgestell mit lackierter Bodenplatte aus Stahl, Säule aus Stahlrohr.
- > Pie de mesa con base en plancha de acero barnizada, columna en acero.

Piani Tavolo / Table Tops /  
Plateaux De Table / Tischplatten /  
Sobres De Mesa  
Ø 60 cm  
Ø 120 cm  
Ø 70 cm  
60x60 cm



## 497A

- > Tavolo alto con basamento in lamiera acciaio verniciata, colonna in tubo acciaio.
- > High table frame in painted steel sheet, steel column.
- > Pied mange debout avec embase et colonne en acier verni.
- > Stehtischgestell mit lackierter Bodenplatte aus Stahl, Säule aus Stahlrohr.
- > Pie de mesa con base en plancha de acero barnizada, columna en acero. Mesa alta.

Piani Tavolo / Table Tops /  
Plateaux De Table / Tischplatten /  
Sobres De Mesa  
Ø 60 cm  
Ø 70 cm  
60x60 cm



## 498Q

- > Tavolo con basamento in lamiera acciaio verniciata, colonna in tubo acciaio.
- > Table frame in painted steel sheet, steel column.
- > Pied de table avec embase et colonne en acier verni.
- > Tischgestell mit lackierter Bodenplatte aus Stahl, Säule aus Stahlrohr.
- > Pie de mesa con base en plancha de acero barnizada, columna en acero.

Piani Tavolo / Table Tops /  
Plateaux De Table / Tischplatten /  
Sobres De Mesa  
Ø 60 cm  
Ø 70 cm  
60x60 cm  
70x70 cm



## 498T

- > Tavolo con basamento in lamiera acciaio verniciata, colonna in tubo acciaio.
- > Table frame in painted steel sheet, steel column.
- > Pied de table avec embase et colonne en acier verni.
- > Tischgestell mit lackierter Bodenplatte aus Stahl, Säule aus Stahlrohr.
- > Pie de mesa con base en plancha de acero barnizada, columna en acero.

Piani Tavolo / Table Tops /  
Plateaux De Table / Tischplatten /  
Sobres De Mesa  
Ø 60 cm  
Ø 70 cm  
60x60 cm  
70x70 cm



## 498A Q

- > Tavolo alto con basamento in lamiera acciaio verniciata, colonna in tubo acciaio.
- > High table frame in painted steel sheet, steel column.
- > Pied mange debout avec embase et colonne en acier verni.
- > Stehtischgestell mit lackierter Bodenplatte aus Stahl, Säule aus Stahlrohr.
- > Pie de mesa con base en plancha de acero barnizada, columna en acero. Mesa alta.

Piani Tavolo / Table Tops /  
Plateaux De Table / Tischplatten /  
Sobres De Mesa  
Ø 60 cm  
Ø 70 cm  
60x60 cm

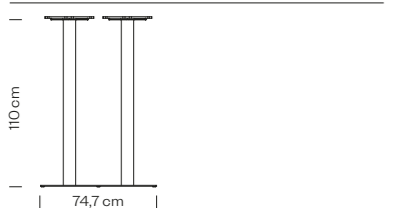

Peso / Weight /  
Poids / Gewicht / Peso **29,2 kg**

Imballo / Packaging /  
Emballage / Verpackung /  
Embalaje **0,06 m³**

Pezzi per scatola /  
Pieces per box /  
Pièces par carton /  
Stücke in einem Karton /  
Piezas por caja **1**

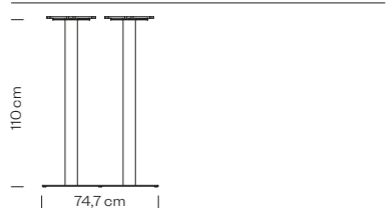

Peso / Weight /  
Poids / Gewicht / Peso **25,2 kg**

Imballo / Packaging /  
Emballage / Verpackung /  
Embalaje **0,06 m³**

Pezzi per scatola /  
Pieces per box /  
Pièces par carton /  
Stücke in einem Karton /  
Piezas por caja **1**

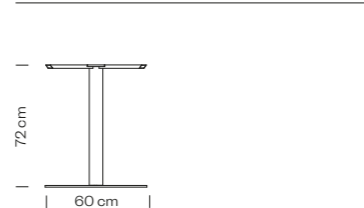

Peso / Weight /  
Poids / Gewicht / Peso **28 kg**

Imballo / Packaging /  
Emballage / Verpackung /  
Embalaje **0,07 m³**

Pezzi per scatola /  
Pieces per box /  
Pièces par carton /  
Stücke in einem Karton /  
Piezas por caja **1**

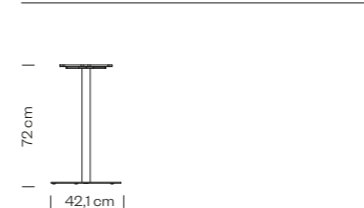

Peso / Weight /  
Poids / Gewicht / Peso **10,7 kg**

Imballo / Packaging /  
Emballage / Verpackung /  
Embalaje **0,06 m³**

Pezzi per scatola /  
Pieces per box /  
Pièces par carton /  
Stücke in einem Karton /  
Piezas por caja **2**

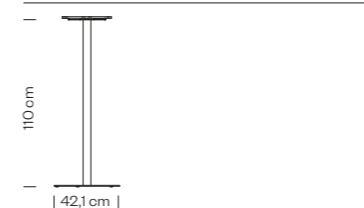

Peso / Weight /  
Poids / Gewicht / Peso **11,4 kg**

Imballo / Packaging /  
Emballage / Verpackung /  
Embalaje **0,06 m³**

Pezzi per scatola /  
Pieces per box /  
Pièces par carton /  
Stücke in einem Karton /  
Piezas por caja **2**

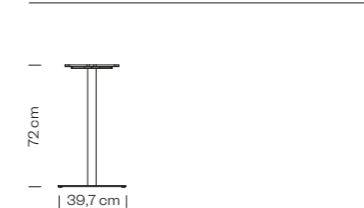

Peso / Weight /  
Poids / Gewicht / Peso **11,9 kg**

Imballo / Packaging /  
Emballage / Verpackung /  
Embalaje **0,06 m³**

Pezzi per scatola /  
Pieces per box /  
Pièces par carton /  
Stücke in einem Karton /  
Piezas por caja **2**

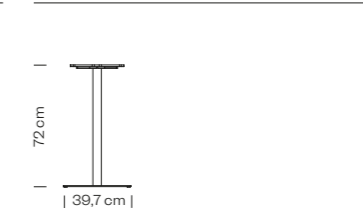

Peso / Weight /  
Poids / Gewicht / Peso **11,9 kg**

Imballo / Packaging /  
Emballage / Verpackung /  
Embalaje **0,06 m³**

Pezzi per scatola /  
Pieces per box /  
Pièces par carton /  
Stücke in einem Karton /  
Piezas por caja **2**

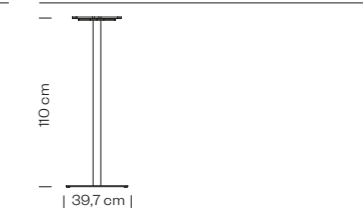

Peso / Weight /  
Poids / Gewicht / Peso **12,9 kg**

Imballo / Packaging /  
Emballage / Verpackung /  
Embalaje **0,06 m³**

Pezzi per scatola /  
Pieces per box /  
Pièces par carton /  
Stücke in einem Karton /  
Piezas por caja **2**



## 498A T

- > Tavolo alto con basamento in lamiera acciaio verniciata, colonna in tubo acciaio.
- > High table frame in painted steel sheet, steel column.
- > Pied mange debout avec embase et colonne en acier verni.
- > Stehtischgestell mit lackierter Bodenplatte aus Stahl, Säule aus Stahlrohr.
- > Pie de mesa con base en plancha de acero barnizada, columna en acero. Mesa alta.

Piani Tavolo / Table Tops / Plateaux De Table / Tischplatten / Sobres De Mesa  
 Ø 60 cm  
 Ø 70 cm  
 60x60 cm

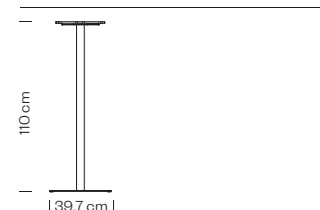

Peso / Weight / Poids / Gewicht / Peso **12,3 kg**

Imballo / Packaging / Emballage / Verpackung / Embalaje **0,06 m³**

Pezzi per scatola / Pieces per box / Pièces par carton / Stücke in einem Karton / Piezas por caja **2**



## 499Q

- > Tavolo con basamento in lamiera acciaio verniciata, colonna in tubo acciaio.
- > Table frame in painted steel sheet, steel column.
- > Pied de table avec embase et colonne en acier verni.
- > Tischgestell mit lackierter Bodenplatte aus Stahl, Säule aus Stahlrohr.
- > Pie de mesa con base en plancha de acero barnizada, columna en acero.

Piani Tavolo / Table Tops / Plateaux De Table / Tischplatten / Sobres De Mesa  
 70x120 cm  
 70x130 cm  
 80x120 cm  
 80x130 cm

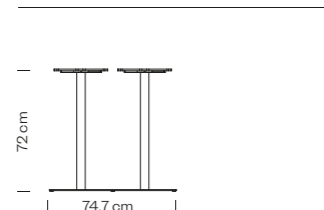

Peso / Weight / Poids / Gewicht / Peso **21,7 kg**

Imballo / Packaging / Emballage / Verpackung / Embalaje **0,06 m³**

Pezzi per scatola / Pieces per box / Pièces par carton / Stücke in einem Karton / Piezas por caja **1**



## 499T

- > Tavolo con basamento in lamiera acciaio verniciata, colonna in tubo acciaio.
- > Table frame in painted steel sheet, steel column.
- > Pied de table avec embase et colonne en acier verni.
- > Tischgestell mit lackierter Bodenplatte aus Stahl, Säule aus Stahlrohr.
- > Pie de mesa con base en plancha de acero barnizada, columna en acero.

Piani Tavolo / Table Tops / Plateaux De Table / Tischplatten / Sobres De Mesa  
 70x120 cm  
 70x130 cm  
 80x120 cm  
 80x130 cm

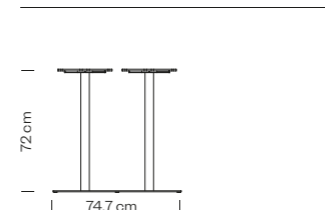

Peso / Weight / Poids / Gewicht / Peso **21 kg**

Imballo / Packaging / Emballage / Verpackung / Embalaje **0,06 m³**

Pezzi per scatola / Pieces per box / Pièces par carton / Stücke in einem Karton / Piezas por caja **1**



## 499A Q

- > Tavolo alto con basamento in lamiera acciaio verniciata, colonna in tubo acciaio.
- > High table frame in painted steel sheet, steel column.
- > Pied mange debout avec embase et colonne en acier verni.
- > Stehtischgestell mit lackierter Bodenplatte aus Stahl, Säule aus Stahlrohr.
- > Pie de mesa con base en plancha de acero barnizada, columna en acero. Mesa alta.

Piani Tavolo / Table Tops / Plateaux De Table / Tischplatten / Sobres De Mesa  
 70x120 cm  
 70x130 cm  
 80x120 cm  
 80x130 cm

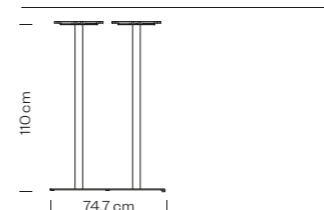

Peso / Weight / Poids / Gewicht / Peso **23,5 kg**

Imballo / Packaging / Emballage / Verpackung / Embalaje **0,06 m³**

Pezzi per scatola / Pieces per box / Pièces par carton / Stücke in einem Karton / Piezas por caja **1**



## 499A T

- > Tavolo alto con basamento in lamiera acciaio verniciata, colonna in tubo acciaio.
- > High table frame in painted steel sheet, steel column.
- > Pied mange debout avec embase et colonne en acier verni.
- > Stehtischgestell mit lackierter Bodenplatte aus Stahl, Säule aus Stahlrohr.
- > Pie de mesa con base en plancha de acero barnizada, columna en acero. Mesa alta.

Piani Tavolo / Table Tops / Plateaux De Table / Tischplatten / Sobres De Mesa  
 70x120 cm  
 70x130 cm  
 80x120 cm  
 80x130 cm

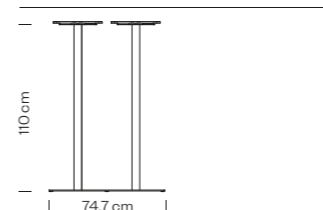

Peso / Weight / Poids / Gewicht / Peso **22,4 kg**

Imballo / Packaging / Emballage / Verpackung / Embalaje **0,06 m³**

Pezzi per scatola / Pieces per box / Pièces par carton / Stücke in einem Karton / Piezas por caja **1**

## AC

- > Finiture telaio (vedi p. 397)
- > Frame finishes (see p. 397)
- > Finitions piètement (voir p. 397)
- > Gestell Fertigungen (sehen S. 397)
- > Acabados estructura (ver p. 397)

## LE

- > Finiture telaio
- > Frame finishes
- > Finitions piètement
- > Gestell Fertigungen
- > Acabados estructura

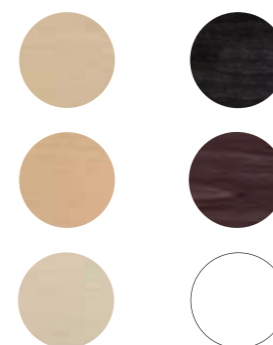

**Accessori / Accessories / Accessoires / Zubehoer / Accesorios**

Piedini Regolabili H 12 mm / H 12 mm adjustable feet / Vérins réglables H 12 mm / Verstellgleitern H. 12 mm / Pies niveladores H 12 mm



xt

design  
rdm

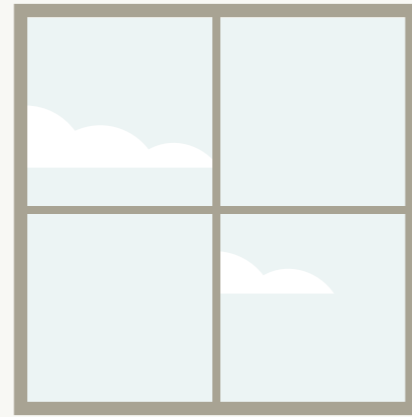

## 477

- > Tavolo con copri-base in acciaio inox lucido o satinato, colonna in acciaio inox lucido o satinato, o faggio.
- > Table frame with base cover in glossy or satin stainless steel. Glossy or satin stainless steel, or beech wood column.
- > Pied de table avec capot pour embase en inox finition brillant ou satiné, colonne en inox finition brillant ou satiné, ou en hêtre.
- > Tisch mit Bodenplatte aus poliertem oder Matt Edelstahl, Säule aus poliertem oder Matt Edelstahl oder Buchenholz.
- > Pie de mesa con capa de la base en acero inox pulido o satinado, columna en acero inox pulido o satinado o en madera de haya.

Piani Tavolo / Table Tops /  
Plateaux De Table / Tischplatten /  
Sobres De Mesa  
Ø 60 cm  
Ø 70 cm  
60x60 cm  
70x70 cm

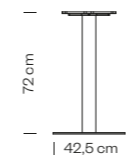

Peso / Weight /  
Poids / Gewicht / Peso **12,5 kg**

Imballo / Packaging /  
Emballage / Verpackung /  
Embalaje **0,06 m³**

Pezzi per scatola /  
Pieces per box /  
Pièces par carton /  
Stücke in einem Karton /  
Piezas por caja **2**

## 477A F

- > Tavolo alto con copri-base in acciaio inox lucido o satinato, colonna in acciaio inox lucido o satinato. Fissaggio a terra.
- > High table frame with base cover in glossy or satin stainless steel, column in glossy or satin stainless steel. Floor fixing.
- > Pied mange debout avec capot pour embase en inox finition brillant ou satiné, colonne en inox finition brillant ou satiné. Pour fixation au sol.
- > Stehtisch mit Bodenplatte aus poliertem oder Matt Edelstahl, Säule aus poliertem oder Matt Edelstahl. Bodemontage.
- > Pie de mesa con capa de la base en acero inox pulido o satinado para fijar al suelo, columna en acero inox pulido o satinado. Mesa alta.

Piani Tavolo / Table Tops /  
Plateaux De Table / Tischplatten /  
Sobres De Mesa  
Ø 60 cm  
Ø 70 cm  
60x60 cm  
70x70 cm

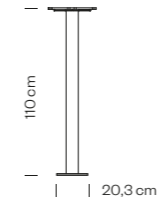

Peso / Weight /  
Poids / Gewicht / Peso **9,8 kg**

Imballo / Packaging /  
Emballage / Verpackung /  
Embalaje **0,06 m³**

Pezzi per scatola /  
Pieces per box /  
Pièces par carton /  
Stücke in einem Karton /  
Piezas por caja **2**

## 477F

- > Tavolo con copri-base in acciaio inox lucido o satinato, colonna in acciaio inox lucido o satinato. Fissaggio a terra.
- > Table frame with base cover in glossy or satin stainless steel, column in glossy or satin stainless steel. Floor fixing.
- > Pied de table avec capot pour embase en inox finition brillant ou satiné, colonne en inox finition brillant ou satiné. Pour fixation au sol.
- > Tisch mit Bodenplatte aus poliertem oder Matt Edelstahl, Säule aus poliertem oder Matt Edelstahl. Bodemontage.
- > Pie de mesa con capa de la base en acero inox pulido o satinado para fijar al suelo, columna en acero inox pulido o satinado.

Piani Tavolo / Table Tops /  
Plateaux De Table / Tischplatten /  
Sobres De Mesa  
Ø 60 cm  
Ø 70 cm  
60x60 cm  
70x70 cm

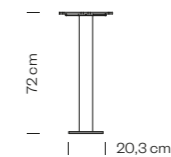

Peso / Weight /  
Poids / Gewicht / Peso **8,5 kg**

Imballo / Packaging /  
Emballage / Verpackung /  
Embalaje **0,06 m³**

Pezzi per scatola /  
Pieces per box /  
Pièces par carton /  
Stücke in einem Karton /  
Piezas por caja **2**

## 477A

- > Tavolo alto con copri-base in acciaio inox lucido o satinato, colonna in acciaio inox lucido o satinato, o faggio.
- > High table frame with base cover in glossy or satin stainless steel. Glossy or satin stainless steel, or beech wood column.
- > Pied mange debout avec capot pour embase en inox finition brillant ou satiné, colonne en inox finition brillant ou satiné, ou en hêtre.
- > Stehtisch mit Bodenplatte aus poliertem oder Matt Edelstahl, Säule aus poliertem oder Matt Edelstahl oder Buchenholz.
- > Pie de mesa con capa de la base en acero inox pulido o satinado, columna en acero inox pulido o satinado o en madera de haya. Mesa alta.

Piani Tavolo / Table Tops /  
Plateaux De Table / Tischplatten /  
Sobres De Mesa  
Ø 60 cm  
Ø 70 cm  
60x60 cm  
70x70 cm

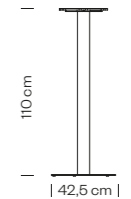

Peso / Weight /  
Poids / Gewicht / Peso **12,5 kg**

Imballo / Packaging /  
Emballage / Verpackung /  
Embalaje **0,06 m³**

Pezzi per scatola /  
Pieces per box /  
Pièces par carton /  
Stücke in einem Karton /  
Piezas por caja **2**



## 477B

- > Tavolo basso con copri-base in acciaio inox lucido o satinato, colonna in acciaio inox lucido o satinato.
- > Low table frame with base cover in glossy or satin stainless steel. Glossy or satin stainless steel column.
- > Pied de table avec capot pour embase en inox finition brillant ou satiné, colonne en inox finition brillant ou satiné. Version hauteur 42,5 cm.
- > Niedriger Tisch mit Bodenplatte aus poliertem oder Matt Edelstahl, Säule aus poliertem oder Matt Edelstahl.
- > Pie de mesa con capa de la base en acero inox pulido o satinado, columna en acero inox pulido o satinado. Mesa baja.

Piani Tavolo / Table Tops / Plateaux De Table / Tischplatten / Sobres De Mesa  
 Ø 80 cm  
 Ø 90 cm  
 Ø 100 cm  
 70x70 cm  
 80x80 cm  
 90x90 cm



## 478

- > Tavolo con copri-base in acciaio inox lucido o satinato, colonna in acciaio inox lucido o satinato, o faggio.
- > Table frame with base cover in glossy or satin stainless steel. Glossy or satin stainless steel, or beech wood column.
- > Pied de table avec capot pour embase en inox finition brillant ou satiné, colonne en inox finition brillant ou satiné, ou en hêtre.
- > Tisch mit Bodenplatte aus poliertem oder Matt Edelstahl, Säule aus poliertem oder Matt Edelstahl oder Buchenholz.
- > Pie de mesa con capa de la base en acero inox pulido o satinado, columna en acero inox pulido o satinado o en madera de haya.

Piani Tavolo / Table Tops / Plateaux De Table / Tischplatten / Sobres De Mesa  
 Ø 80 cm  
 Ø 90 cm  
 Ø 100 cm  
 70x70 cm  
 80x80 cm  
 90x90 cm



## 478A

- > Tavolo alto con copri-base in acciaio inox lucido o satinato, colonna in acciaio inox lucido o satinato, o faggio.
- > High table frame with base cover in glossy or satin stainless steel. Glossy or satin stainless steel, or beech wood column.
- > Pied mange debout avec capot pour embase en inox finition brillant ou satiné, colonne en inox finition brillant ou satiné, ou en hêtre.
- > Stehtisch mit Bodenplatte aus poliertem oder Matt Edelstahl, Säule aus poliertem oder Matt Edelstahl oder Buchenholz.
- > Pie de mesa con capa de la base en acero inox pulido o satinado, columna en acero inox pulido o satinado o en madera de haya. Mesa alta.

Piani Tavolo / Table Tops / Plateaux De Table / Tischplatten / Sobres De Mesa  
 Ø 80 cm  
 Ø 90 cm  
 70x70 cm



## 478B

- > Tavolo basso con copri-base in acciaio inox lucido o satinato, colonna in acciaio inox lucido o satinato.
- > Low table frame with base cover in glossy or satin stainless steel. Glossy or satin stainless steel column.
- > Pied de table avec capot pour embase en inox finition brillant ou satiné, colonne en inox finition brillant ou satiné. Version hauteur 42,5 cm.
- > Niedriger Tisch mit Bodenplatte aus poliertem oder Matt Edelstahl, Säule aus poliertem oder Matt Edelstahl.
- > Pie de mesa con capa de la base en acero inox pulido o satinado, columna en acero inox pulido o satinado. Mesa baja.

Piani Tavolo / Table Tops / Plateaux De Table / Tischplatten / Sobres De Mesa  
 Ø 80 cm  
 Ø 90 cm  
 70x70 cm  
 80x80 cm



## 479Q

- > Tavolo con copri-base in acciaio inox lucido o satinato, colonna in acciaio inox lucido o satinato, o faggio.
- > Table frame with base cover in glossy or satin stainless steel. Glossy or satin stainless steel, or beech wood column.
- > Pied de table avec capot pour embase en inox finition brillant ou satiné, colonne en inox finition brillant ou satiné, ou en hêtre.
- > Tisch mit Bodenplatte aus poliertem oder Matt Edelstahl, Säule aus poliertem oder Matt Edelstahl oder Buchenholz.
- > Pie de mesa con capa de la base en acero inox pulido o satinado, columna en acero inox pulido o satinado o en madera de haya.

Piani Tavolo / Table Tops / Plateaux De Table / Tischplatten / Sobres De Mesa  
 Ø 60 cm  
 Ø 70 cm  
 60x60 cm  
 70x70 cm



## 479T

- > Tavolo con copri-base in acciaio inox lucido o satinato, colonna in acciaio inox lucido o satinato, o faggio.
- > Table frame with base cover in glossy or satin stainless steel. Glossy or satin stainless steel, or beech wood column.
- > Pied de table avec capot pour embase en inox finition brillant ou satiné, colonne en inox finition brillant ou satiné, ou en hêtre.
- > Tisch mit Bodenplatte aus poliertem oder Matt Edelstahl, Säule aus poliertem oder Matt Edelstahl oder Buchenholz.
- > Pie de mesa con capa de la base en acero inox pulido o satinado, columna en acero inox pulido o satinado o en madera de haya.

Piani Tavolo / Table Tops / Plateaux De Table / Tischplatten / Sobres De Mesa  
 Ø 60 cm  
 Ø 70 cm  
 60x60 cm  
 70x70 cm



## 479A Q

- > Tavolo alto con copri-base in acciaio inox lucido o satinato, colonna in acciaio inox lucido o satinato, o faggio.
- > High table frame with base cover in glossy or satin stainless steel. Glossy or satin stainless steel column.
- > Pied mange debout avec capot pour embase en inox finition brillant ou satiné, colonne en inox finition brillant ou satiné.
- > Stehtisch mit Bodenplatte aus poliertem oder Matt Edelstahl, Säule aus poliertem oder Matt Edelstahl.
- > Pie de mesa con capa de la base en acero inox pulido o satinado, columna en acero inox pulido o satinado. Mesa alta.

Piani Tavolo / Table Tops / Plateaux De Table / Tischplatten / Sobres De Mesa  
 Ø 60 cm  
 Ø 70 cm  
 60x60 cm



## 479A T

- > Tavolo alto con copri-base in acciaio inox lucido o satinato, colonna in acciaio inox lucido o satinato, o faggio.
- > High table frame with base cover in glossy or satin stainless steel. Glossy or satin stainless steel, or beech wood column.
- > Pied mange debout avec capot pour embase en inox finition brillant ou satiné, colonne en inox finition brillant ou satiné, ou en hêtre.
- > Stehtisch mit Bodenplatte aus poliertem oder Matt Edelstahl, Säule aus poliertem oder Matt Edelstahl oder Buchenholz.
- > Pie de mesa con capa de la base en acero inox pulido o satinado, columna en acero inox pulido o satinado o en madera de haya. Mesa alta.

Piani Tavolo / Table Tops / Plateaux De Table / Tischplatten / Sobres De Mesa  
 Ø 60 cm  
 Ø 70 cm  
 60x60 cm

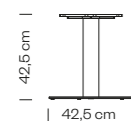

Peso / Weight / Poids / Gewicht / Peso **11,5 kg**

Imballo / Packaging / Emballage / Verpackung / Embalaje **0,05 m³**

Pezzi per scatola / Pieces per box / Pièces par carton / Stücke in einem Karton / Piezas por caja **2**

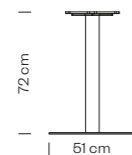

Peso / Weight / Poids / Gewicht / Peso **16,1 kg**

Imballo / Packaging / Emballage / Verpackung / Embalaje **0,05 m³**

Pezzi per scatola / Pieces per box / Pièces par carton / Stücke in einem Karton / Piezas por caja **1**

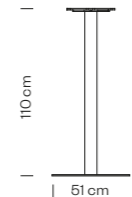

Peso / Weight / Poids / Gewicht / Peso **17,4 kg**

Imballo / Packaging / Emballage / Verpackung / Embalaje **0,05 m³**

Pezzi per scatola / Pieces per box / Pièces par carton / Stücke in einem Karton / Piezas por caja **2**

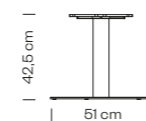

Peso / Weight / Poids / Gewicht / Peso **15,1 kg**

Imballo / Packaging / Emballage / Verpackung / Embalaje **0,05 m³**

Pezzi per scatola / Pieces per box / Pièces par carton / Stücke in einem Karton / Piezas por caja **1**

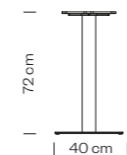

Peso / Weight / Poids / Gewicht / Peso **15 kg**

Imballo / Packaging / Emballage / Verpackung / Embalaje **0,06 m³**

Pezzi per scatola / Pieces per box / Pièces par carton / Stücke in einem Karton / Piezas por caja **2**

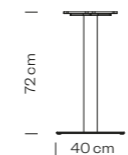

Peso / Weight / Poids / Gewicht / Peso **13,5 kg**

Imballo / Packaging / Emballage / Verpackung / Embalaje **0,06 m³**

Pezzi per scatola / Pieces per box / Pièces par carton / Stücke in einem Karton / Piezas por caja **2**

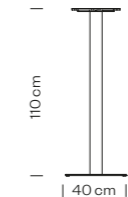

Peso / Weight / Poids / Gewicht / Peso **17 kg**

Imballo / Packaging / Emballage / Verpackung / Embalaje **0,06 m³**

Pezzi per scatola / Pieces per box / Pièces par carton / Stücke in einem Karton / Piezas por caja **2**

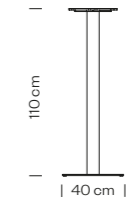

Peso / Weight / Poids / Gewicht / Peso **14,8 kg**

Imballo / Packaging / Emballage / Verpackung / Embalaje **0,06 m³**

Pezzi per scatola / Pieces per box / Pièces par carton / Stücke in einem Karton / Piezas por caja **2**



## 479B T

- > Tavolo basso con copri-base in acciaio inox lucido o satinato, colonna in acciaio inox lucido o satinato.
- > Low table frame with base cover in glossy or satin stainless steel. Glossy or satin stainless steel column.
- > Pied de table avec capot pour embase en inox finition brillant ou satiné, colonne en inox finition brillant ou satiné. Version hauteur 42,5 cm.
- > Niedriger Tisch mit Bodenplatte aus poliertem oder Matt Edelstahl, Säule aus poliertem oder Matt Edelstahl.
- > Pie de mesa con capa de la base en acero inox pulido o satinado, columna en acero inox pulido o satinado. Mesa baja.

Piani Tavolo / Table Tops / Plateaux De Table / Tischplatten / Sobres De Mesa  
 Ø 60 cm  
 Ø 70 cm  
 60x60 cm  
 70x70 cm



## 480Q

- > Tavolo con copri-base in acciaio inox lucido o satinato, colonna in acciaio inox lucido o satinato, o faggio.
- > Table frame with base cover in glossy or satin stainless steel. Glossy or satin stainless steel, or beech wood column.
- > Pied de table avec capot pour embase en inox finition brillant ou satiné, colonne en inox finition brillant ou satiné, ou en hêtre.
- > Tisch mit Bodenplatte aus poliertem oder Matt Edelstahl, Säule aus poliertem oder Matt Edelstahl oder Buchenholz.
- > Pie de mesa con capa de la base en acero inox pulido o satinado, columna en acero inox pulido o satinado o en madera de haya.

Piani Tavolo / Table Tops / Plateaux De Table / Tischplatten / Sobres De Mesa  
 Ø 80 cm  
 Ø 90 cm  
 80x80 cm  
 90x90 cm



## 480T

- > Tavolo con copri-base in acciaio inox lucido o satinato, colonna in acciaio inox lucido o satinato, o faggio.
- > Table frame with base cover in glossy or satin stainless steel. Glossy or satin stainless steel, or beech wood column.
- > Pied de table avec capot pour embase en inox finition brillant ou satiné, colonne en inox finition brillant ou satiné, ou en hêtre.
- > Tisch mit Bodenplatte aus poliertem oder Matt Edelstahl, Säule aus poliertem oder Matt Edelstahl oder Buchenholz.
- > Pie de mesa con capa de la base en acero inox pulido o satinado, columna en acero inox pulido o satinado o en madera de haya.

Piani Tavolo / Table Tops / Plateaux De Table / Tischplatten / Sobres De Mesa  
 Ø 80 cm  
 Ø 90 cm  
 80x80 cm  
 90x90 cm



## 480A Q

- > Tavolo alto con copri-base in acciaio inox lucido o satinato, colonna in acciaio inox lucido o satinato.
- > High table frame with base cover in glossy or satin stainless steel. Glossy or satin stainless steel column.
- > Pied mange debout avec capot pour embase en inox finition brillant ou satiné, colonne en inox finition brillant ou satiné.
- > Stehtisch mit Bodenplatte aus poliertem oder Matt Edelstahl, Säule aus poliertem oder Matt Edelstahl.
- > Pie de mesa con capa de la base en acero inox pulido o satinado, columna en acero inox pulido o satinado. Mesa alta.

Piani Tavolo / Table Tops / Plateaux De Table / Tischplatten / Sobres De Mesa  
 Ø 80 cm  
 Ø 90 cm  
 70x70 cm  
 80x80 cm



## 480A T

- > Tavolo alto con copri-base in acciaio inox lucido o satinato, colonna in acciaio inox lucido o satinato, o faggio.
- > High table frame with base cover in glossy or satin stainless steel, column in glossy, satin stainless steel or beech wood.
- > Pied mange debout avec capot pour embase en inox finition brillant ou satiné, colonne en inox finition brillant ou satiné, ou en hêtre.
- > Stehtisch mit Bodenplatte aus poliertem oder Matt Edelstahl, Säule aus poliertem oder Matt Edelstahl oder Buchenholz.
- > Pie de mesa con capa de la base en acero inox pulido o satinado, columna en acero inox pulido o satinado o en madera de haya. Mesa alta.

Piani Tavolo / Table Tops / Plateaux De Table / Tischplatten / Sobres De Mesa  
 Ø 80 cm  
 Ø 90 cm  
 80x80 cm  
 90x90 cm



## 480B T

- > Tavolo basso con copri-base in acciaio inox lucido o satinato, colonna in acciaio inox lucido o satinato.
- > Low table frame with base cover in glossy or satin stainless steel. Glossy or satin stainless steel column.
- > Pied de table avec capot pour embase en inox finition brillant ou satiné, colonne en inox finition brillant ou satiné. Version hauteur 42,5 cm.
- > Niedriger Tisch mit Bodenplatte aus poliertem oder Matt Edelstahl, Säule aus poliertem oder Matt Edelstahl.
- > Pie de mesa con capa de la base en acero inox pulido o satinado, columna en acero inox pulido o satinado. Mesa baja.

Piani Tavolo / Table Tops / Plateaux De Table / Tischplatten / Sobres De Mesa  
 Ø 80 cm  
 Ø 90 cm  
 80x80 cm  
 90x90 cm



## 490Q

- > Tavolo con copri-base in acciaio inox lucido o satinato, colonna in acciaio inox lucido o satinato, o faggio.
- > Table frame with base cover in glossy or satin stainless steel. Glossy, satin stainless steel or beech wood column.
- > Pied de table avec capot pour embase en inox finition brillant ou satiné, colonne en inox finition brillant ou satiné, ou en hêtre.
- > Tisch mit Bodenplatte aus poliertem oder Matt Edelstahl, Säule aus poliertem oder Matt Edelstahl oder Buchenholz.
- > Pie de mesa con capa de la base en acero inox pulido o satinado, columna en acero inox pulido o satinado o en madera de haya.

Piani Tavolo / Table Tops / Plateaux De Table / Tischplatten / Sobres De Mesa  
 70x120 cm  
 70x130 cm  
 80x120 cm  
 80x130 cm  
 80x140 cm



## 490T

- > Tavolo con copri-base in acciaio inox lucido o satinato, colonna in acciaio inox lucido o satinato, o faggio.
- > Table frame with base cover in glossy or satin stainless steel. Glossy, satin stainless steel or beech wood column.
- > Pied de table avec capot pour embase en inox finition brillant ou satiné, colonne en inox finition brillant ou satiné, ou en hêtre.
- > Tisch mit Bodenplatte aus poliertem oder Matt Edelstahl, Säule aus poliertem oder Matt Edelstahl oder Buchenholz.
- > Pie de mesa con capa de la base en acero inox pulido o satinado, columna en acero inox pulido o satinado o en madera de haya.

Piani Tavolo / Table Tops / Plateaux De Table / Tischplatten / Sobres De Mesa  
 70x120 cm  
 70x130 cm  
 80x120 cm  
 80x130 cm  
 80x140 cm

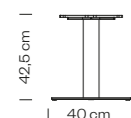

Peso / Weight / Poids / Gewicht / Peso **12,5 kg**

Imballo / Packaging / Emballage / Verpackung / Embalaje **0,06 m³**

Pezzi per scatola / Pieces per box / Pièces par carton / Stücke in einem Karton / Piezas por caja **2**

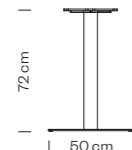

Peso / Weight / Poids / Gewicht / Peso **20 kg**

Imballo / Packaging / Emballage / Verpackung / Embalaje **0,05 m³**

Pezzi per scatola / Pieces per box / Pièces par carton / Stücke in einem Karton / Piezas por caja **1**

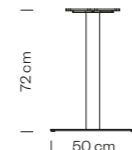

Peso / Weight / Poids / Gewicht / Peso **18,5 kg**

Imballo / Packaging / Emballage / Verpackung / Embalaje **0,05 m³**

Pezzi per scatola / Pieces per box / Pièces par carton / Stücke in einem Karton / Piezas por caja **1**



Peso / Weight / Poids / Gewicht / Peso **20 kg**

Imballo / Packaging / Emballage / Verpackung / Embalaje **0,05 m³**

Pezzi per scatola / Pieces per box / Pièces par carton / Stücke in einem Karton / Piezas por caja **2**



Peso / Weight / Poids / Gewicht / Peso **19,8 kg**

Imballo / Packaging / Emballage / Verpackung / Embalaje **0,05 m³**

Pezzi per scatola / Pieces per box / Pièces par carton / Stücke in einem Karton / Piezas por caja **2**

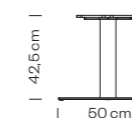

Peso / Weight / Poids / Gewicht / Peso **17,5 kg**

Imballo / Packaging / Emballage / Verpackung / Embalaje **0,05 m³**

Pezzi per scatola / Pieces per box / Pièces par carton / Stücke in einem Karton / Piezas por caja **1**

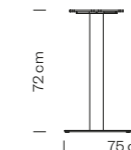

Peso / Weight / Poids / Gewicht / Peso **28,5 kg**

Imballo / Packaging / Emballage / Verpackung / Embalaje **0,06 m³**

Pezzi per scatola / Pieces per box / Pièces par carton / Stücke in einem Karton / Piezas por caja **1**

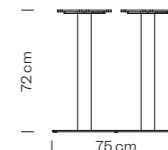

Peso / Weight / Poids / Gewicht / Peso **26,1 kg**

Imballo / Packaging / Emballage / Verpackung / Embalaje **0,06 m³**

Pezzi per scatola / Pieces per box / Pièces par carton / Stücke in einem Karton / Piezas por caja **1**





## 490A Q

- > Tavolo alto con copri-base in acciaio inox lucido o satinato, colonna in acciaio inox lucido o satinato.
- > High table frame with base cover in glossy or satin stainless steel, column in glossy or satin stainless steel.
- > Pied mange debout avec capot pour embase en inox finition brillant ou satiné, colonne en inox finition brillant ou satiné.
- > Stehtisch mit Bodenplatte aus poliertem oder Matt Edelstahl, Säule aus poliertem oder Matt Edelstahl.
- > Pie de mesa con capa de la base en acero inox pulido o satinado, columna en acero inox pulido o satinado. Mesa alta.

Piani Tavolo / Table Tops / Plateaux De Table / Tischplatten / Sobres De Mesa  
70x120 cm  
70x130 cm  
80x120 cm  
80x130 cm

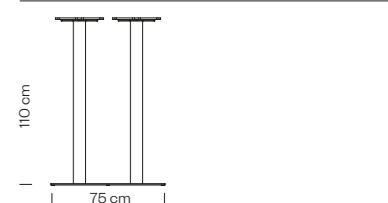

Peso / Weight / Poids / Gewicht / Peso **32,6 kg**

Imballo / Packaging / Emballage / Verpackung / Embalaje **0,06 m³**

Pezzi per scatola / Pieces per box / Pièces par carton / Stücke in einem Karton / Piezas por caja **1**



## 490A T

- > Tavolo alto con copri-base in acciaio inox lucido o satinato, colonna in acciaio inox lucido o satinato, o legno.
- > High table frame with base cover in glossy or satin stainless steel, or wood column.
- > Pied mange debout avec capot pour embase en inox finition brillant ou satiné, colonne en inox finition brillant ou satiné, ou en hêtre.
- > Stehtisch mit Bodenplatte aus poliertem oder Matt Edelstahl, Säule aus poliertem oder Matt Edelstahl oder Buchenholz.
- > Pie de mesa con capa de la base en acero inox pulido o satinado, o en madera de haya. Mesa alta.

Piani Tavolo / Table Tops / Plateaux De Table / Tischplatten / Sobres De Mesa  
70x120 cm  
70x130 cm  
80x120 cm  
80x130 cm

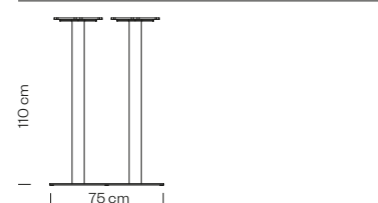

Peso / Weight / Poids / Gewicht / Peso **28,5 kg**

Imballo / Packaging / Emballage / Verpackung / Embalaje **0,06 m³**

Pezzi per scatola / Pieces per box / Pièces par carton / Stücke in einem Karton / Piezas por caja **1**



## 492

- > Tavolo con copri-base in acciaio inox lucido o satinato, colonna in acciaio inox lucido o satinato, o legno.
- > Table frame with base cover in glossy or satin stainless steel, or wood column.
- > Pied de table avec capot pour embase en inox finition brillant ou satiné, colonne en inox finition brillant ou satiné, ou en hêtre.
- > Tisch mit Bodenplatte aus poliertem oder Matt Edelstahl, Säule aus poliertem oder Matt Edelstahl oder Buchenholz.
- > Pie de mesa con capa de la base en acero inox pulido o satinado, o en madera de haya.

Piani Tavolo / Table Tops / Plateaux De Table / Tischplatten / Sobres De Mesa  
Ø 110 cm  
Ø 120 cm  
Ø 130 cm  
100x100 cm  
110x110 cm

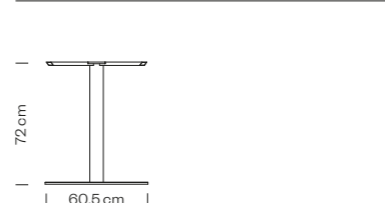

Peso / Weight / Poids / Gewicht / Peso **30,7 kg**

Imballo / Packaging / Emballage / Verpackung / Embalaje **0,07 m³**

Pezzi per scatola / Pieces per box / Pièces par carton / Stücke in einem Karton / Piezas por caja **1**



## 494

- > Tavolo con copri-base in acciaio inox lucido o satinato, colonna in acciaio inox lucido o satinato.
- > Table frame with base cover in glossy or satin stainless steel, column in glossy or satin stainless steel.
- > Pied de table avec capot pour embase en inox finition brillant ou satiné, colonne en inox finition brillant ou satiné.
- > Tisch mit Bodenplatte aus poliertem oder Matt Edelstahl, Säule aus poliertem oder Matt Edelstahl.
- > Pie de mesa con capa de la base en acero inox pulido o satinado, columna en acero inox pulido o satinado.

Piani Tavolo / Table Tops / Plateaux De Table / Tischplatten / Sobres De Mesa  
Ø 60 cm  
Ø 70 cm  
60x60 cm



Peso / Weight / Poids / Gewicht / Peso **11,7 kg**

Imballo / Packaging / Emballage / Verpackung / Embalaje **0,06 m³**

Pezzi per scatola / Pieces per box / Pièces par carton / Stücke in einem Karton / Piezas por caja **2**



## 494A

- > Tavolo alto con copri-base in acciaio inox lucido o satinato, colonna in acciaio inox lucido o satinato.
- > High table frame with base cover in glossy or satin stainless steel, column in glossy or satin stainless steel.
- > Pied mange debout avec capot pour embase en inox finition brillant ou satiné, colonne en inox finition brillant ou satiné.
- > Stehtisch mit Bodenplatte aus poliertem oder Matt Edelstahl, Säule aus poliertem oder Matt Edelstahl.
- > Pie de mesa con capa de la base en acero inox pulido o satinado, columna en acero inox pulido o satinado. Mesa alta.

Piani Tavolo / Table Tops / Plateaux De Table / Tischplatten / Sobres De Mesa  
Ø 60 cm  
Ø 70 cm  
60x60 cm

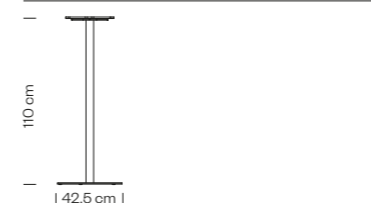

Peso / Weight / Poids / Gewicht / Peso **12,6 kg**

Imballo / Packaging / Emballage / Verpackung / Embalaje **0,06 m³**

Pezzi per scatola / Pieces per box / Pièces par carton / Stücke in einem Karton / Piezas por caja **2**



## 495Q

- > Tavolo con copri-base in acciaio inox lucido o satinato, colonna in acciaio inox lucido o satinato.
- > Table frame with base cover in glossy or satin stainless steel, column in glossy or satin stainless steel.
- > Pied de table avec capot pour embase en inox finition brillant ou satiné, colonne en inox finition brillant ou satiné.
- > Tisch mit Bodenplatte aus poliertem oder Matt Edelstahl, Säule aus poliertem oder Matt Edelstahl.
- > Pie de mesa con capa de la base en acero inox pulido o satinado, columna en acero inox pulido o satinado.

Piani Tavolo / Table Tops / Plateaux De Table / Tischplatten / Sobres De Mesa  
Ø 60 cm  
Ø 70 cm  
60x60 cm  
70x70 cm



Peso / Weight / Poids / Gewicht / Peso **13 kg**

Imballo / Packaging / Emballage / Verpackung / Embalaje **0,06 m³**

Pezzi per scatola / Pieces per box / Pièces par carton / Stücke in einem Karton / Piezas por caja **2**



## 495T

- > Tavolo con copri-base in acciaio inox lucido o satinato, colonna in acciaio inox lucido o satinato.
- > Table frame with base cover in glossy or satin stainless steel, column in glossy or satin stainless steel.
- > Pied de table avec capot pour embase en inox finition brillant ou satiné, colonne en inox finition brillant ou satiné.
- > Tisch mit Bodenplatte aus poliertem oder Matt Edelstahl, Säule aus poliertem oder Matt Edelstahl.
- > Pie de mesa con capa de la base en acero inox pulido o satinado, columna en acero inox pulido o satinado.

Piani Tavolo / Table Tops / Plateaux De Table / Tischplatten / Sobres De Mesa  
Ø 60 cm  
Ø 70 cm  
60x60 cm  
70x70 cm



Peso / Weight / Poids / Gewicht / Peso **12,7 kg**

Imballo / Packaging / Emballage / Verpackung / Embalaje **0,06 m³**

Pezzi per scatola / Pieces per box / Pièces par carton / Stücke in einem Karton / Piezas por caja **2**



## 495A Q

- > Tavolo alto con copri-base in acciaio inox lucido o satinato, colonna in acciaio inox lucido o satinato.
- > High table frame with base cover in glossy or satin stainless steel, column in glossy or satin stainless steel.
- > Pied mange debout avec capot pour embase en inox finition brillant ou satiné, colonne en inox finition brillant ou satiné.
- > Stehtisch mit Bodenplatte aus poliertem oder Matt Edelstahl, Säule aus poliertem oder Matt Edelstahl.
- > Pie de mesa con capa de la base en acero inox pulido o satinado, columna en acero inox pulido o satinado. Mesa alta.

Piani Tavolo / Table Tops / Plateaux De Table / Tischplatten / Sobres De Mesa  
Ø 60 cm  
Ø 70 cm  
60x60 cm

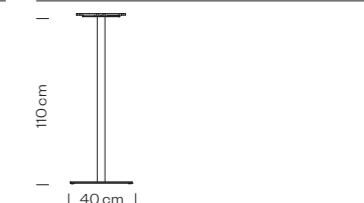

Peso / Weight / Poids / Gewicht / Peso **14,1 kg**

Imballo / Packaging / Emballage / Verpackung / Embalaje **0,06 m³**

Pezzi per scatola / Pieces per box / Pièces par carton / Stücke in einem Karton / Piezas por caja **2**



## 495A T

- > Tavolo alto con copri-base in acciaio inox lucido o satinato, colonna in acciaio inox lucido o satinato.
- > High table frame with base cover in glossy or satin stainless steel, column in glossy or satin stainless steel.
- > Pied mange debout avec capot pour embase en inox finition brillant ou satiné, colonne en inox finition brillant ou satiné.
- > Stehtisch mit Bodenplatte aus poliertem oder Matt Edelstahl, Säule aus poliertem oder Matt Edelstahl.
- > Pie de mesa con capa de la base en acero inox pulido o satinado, columna en acero inox pulido o satinado. Mesa alta.

Piani Tavolo / Table Tops /  
Plateaux De Table / Tischplatten /  
Sobres De Mesa  
Ø 60 cm  
Ø 70 cm  
60x60 cm

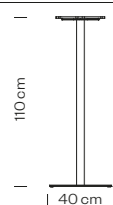

Peso / Weight /  
Poids / Gewicht / Peso **13,6 kg**

Imballo / Packaging /  
Emballage / Verpackung /  
Embalaje **0,06 m³**

Pezzi per scatola /  
Pieces per box /  
Pièces par carton /  
Stücke in einem Karton /  
Piezas por caja **2**



## 496Q

- > Tavolo con copri-base in acciaio inox lucido o satinato, colonna in acciaio inox lucido o satinato.
- > Table frame with base cover in glossy or satin stainless steel, column in glossy or satin stainless steel.
- > Pied de table avec capot pour embase en inox finition brillant ou satiné, colonne en inox finition brillant ou satiné.
- > Tisch mit Bodenplatte aus poliertem oder Matt Edelstahl, Säule aus poliertem oder Matt Edelstahl.
- > Pie de mesa con capa de la base en acero inox pulido o satinado, columna en acero inox pulido o satinado.

Piani Tavolo / Table Tops /  
Plateaux De Table / Tischplatten /  
Sobres De Mesa  
70x120 cm  
70x130 cm  
80x120 cm  
80x130 cm

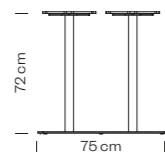

Peso / Weight /  
Poids / Gewicht / Peso **25,7 kg**

Imballo / Packaging /  
Emballage / Verpackung /  
Embalaje **0,06 m³**

Pezzi per scatola /  
Pieces per box /  
Pièces par carton /  
Stücke in einem Karton /  
Piezas por caja **1**



## 496T

- > Tavolo con copri-base in acciaio inox lucido o satinato, colonna in acciaio inox lucido o satinato.
- > Table frame with base cover in glossy or satin stainless steel, column in glossy or satin stainless steel.
- > Pied de table avec capot pour embase en inox finition brillant ou satiné, colonne en inox finition brillant ou satiné.
- > Tisch mit Bodenplatte aus poliertem oder Matt Edelstahl, Säule aus poliertem oder Matt Edelstahl.
- > Pie de mesa con capa de la base en acero inox pulido o satinado, columna en acero inox pulido o satinado.

Piani Tavolo / Table Tops /  
Plateaux De Table / Tischplatten /  
Sobres De Mesa  
70x120 cm  
70x130 cm  
80x120 cm  
80x130 cm

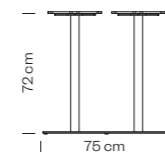

Peso / Weight /  
Poids / Gewicht / Peso **24,5 kg**

Imballo / Packaging /  
Emballage / Verpackung /  
Embalaje **0,06 m³**

Pezzi per scatola /  
Pieces per box /  
Pièces par carton /  
Stücke in einem Karton /  
Piezas por caja **1**



## 496A Q

- > Tavolo alto con copri-base in acciaio inox lucido o satinato, colonna in acciaio inox lucido o satinato.
- > High table frame with base cover in glossy or satin stainless steel, column in glossy or satin stainless steel.
- > Pied mange debout avec capot pour embase en inox finition brillant ou satiné, colonne en inox finition brillant ou satiné.
- > Stehtisch mit Bodenplatte aus poliertem oder Matt Edelstahl, Säule aus poliertem oder Matt Edelstahl.
- > Pie de mesa con capa de la base en acero inox pulido o satinado, columna en acero inox pulido o satinado. Mesa alta.

Piani Tavolo / Table Tops /  
Plateaux De Table / Tischplatten /  
Sobres De Mesa  
70x120 cm  
70x130 cm  
80x120 cm  
80x130 cm

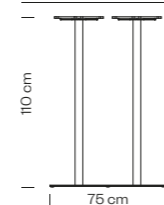

Peso / Weight /  
Poids / Gewicht / Peso **28 kg**

Imballo / Packaging /  
Emballage / Verpackung /  
Embalaje **0,06 m³**

Pezzi per scatola /  
Pieces per box /  
Pièces par carton /  
Stücke in einem Karton /  
Piezas por caja **1**



## 496A T

- > Tavolo alto con copri-base in acciaio inox lucido o satinato, colonna in acciaio inox lucido o satinato.
- > High table frame with base cover in glossy or satin stainless steel, column in glossy or satin stainless steel.
- > Pied mange debout avec capot pour embase en inox finition brillant ou satiné, colonne en inox finition brillant ou satiné.
- > Stehtisch mit Bodenplatte aus poliertem oder Matt Edelstahl, Säule aus poliertem oder Matt Edelstahl.
- > Pie de mesa con capa de la base en acero inox pulido o satinado, columna en acero inox pulido o satinado. Mesa alta.

Piani Tavolo / Table Tops /  
Plateaux De Table / Tischplatten /  
Sobres De Mesa  
70x120 cm  
70x130 cm  
80x120 cm  
80x130 cm



Peso / Weight /  
Poids / Gewicht / Peso **26,3 kg**

Imballo / Packaging /  
Emballage / Verpackung /  
Embalaje **0,06 m³**

Pezzi per scatola /  
Pieces per box /  
Pièces par carton /  
Stücke in einem Karton /  
Piezas por caja **1**

# AX

- > Finiture telaio (vedi p. 398)
- > Frame finishes (see p. 398)
- > Finitions piètement (voir p. 398)
- > Gestell Fertigungen (sehen S. 398)
- > Acabados estructura (ver p. 398)

# LE

- > Finiture telaio
- > Frame finishes
- > Finitions piètement
- > Gestell Fertigungen
- > Acabados estructura



**Accessori / Accessories /  
Accessoires / Zubehoer /  
Accesorios**

Piedini Regolabili H 12 mm /  
H 12 mm adjustable feet /  
Vérins réglables H 12 mm /  
Verstellgleitern H. 12 mm /  
Pies niveladores H 12 mm

# tipologie piani tavoli / top types / types de plateaux / tischplatten modellen / tipo de sobres de mesa

## LAM

laminato / laminate / stratifié / laminat / laminado

### b lam

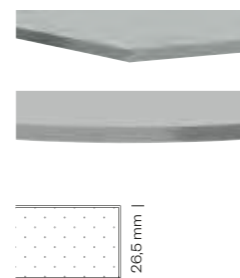

Piano e bordo in laminato /  
Laminate table top with laminate edge /  
Plateau en stratifié avec bord en stratifié /  
Laminat Tischplatte mit Kante aus Laminat /  
Sobre de mesa en laminado con borde en laminado

### b abs

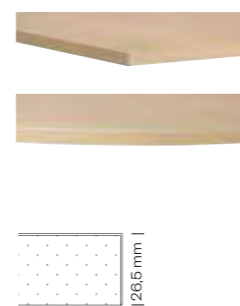

Piano in laminato, con bordo in ABS colore rovere, wengé, nero o bianco /  
Table top laminate with oak, wengé, black or white coloured ABS edge /  
Plateau en stratifié avec bord en ABS, couleurs chêne, wengé, noir ou blanc /  
Laminat Tischplatte mit ABS Kante, Wengé, Eiche, Schwarz oder Weiss /  
Sobre de mesa en laminado con borde en ABS roble, wengé, negro o blanco

### s2

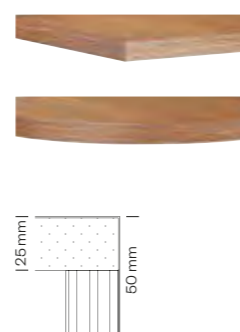

Piano e bordo in laminato /  
Laminate table top with laminate edge /  
Plateau en stratifié avec bord en stratifié /  
Laminat Tischplatte mit Kante aus Laminat /  
Sobre de mesa en laminado con borde en laminado

### s2 abs

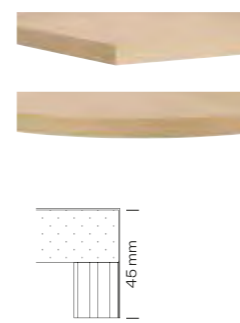

Piano in laminato, con bordo in ABS colore rovere, wengé, nero o bianco /  
Table top laminate with oak, wengé, black or white coloured ABS edge /  
Plateau en stratifié avec bord en ABS, couleurs chêne, wengé, noir ou blanc /  
Laminat Tischplatte mit ABS Kante, Wengé, Eiche, Schwarz oder Weiss /  
Sobre de mesa en laminado con borde en ABS roble, wengé, negro o blanco

### 60°R

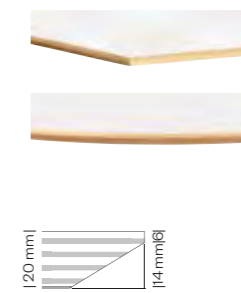

Piano in multistrato rivestito in laminato con bordo 60°R in faggio /  
Laminate plywood table top with 60° reversed beech edge /  
Plateau plaqué bois, avec dessus en stratifié et bord aile d'avion /  
Laminat Tischplatte mit 60°R buchen Kante /  
Sobre en multicapa cubierto en laminado con borde de haya 60°R

### harvey



Pannello in alveolare di alluminio placcato con laminato e bordato in ABS - angolo 90° /  
Aluminium cellular top in plated laminate and ABS edge - 90° angle /  
Plateau auto portant en aluminium alvéolaire contreplaqué en stratifié et chants en ABS - angle à 90° /  
Aluminium-Honigwabenplatte mit Laminatsperrholz und ABS-Kante - Ecke 90° /  
Panel en alveolar de aluminio chapado con laminado y con borde en ABS - esquina 90°

Pannello composito in alluminio placcato con laminato e bordato in ABS - angolo arrondato /  
Aluminium composite top in plated laminate and ABS edge - rounded angle /  
Plateau auto portant composite en aluminium contreplaqué en stratifié et chants en ABS - angle arrondi /  
Aluminiumwabenplatte mit Laminatsperrholz und ABS-Kante - gerundete Ecke /  
Panel composito en aluminio chapado con laminado y con borde en ABS - esquina redondeada

# tipologie piani tavoli / top types / types de plateaux / tischplatten modellen / tipo de sobres de mesa

## STR

stratificato HPL / HPL solid laminate / stratifié HPL /  
HPL compactplatte / estratificado HPL

### compact

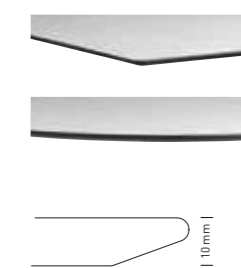
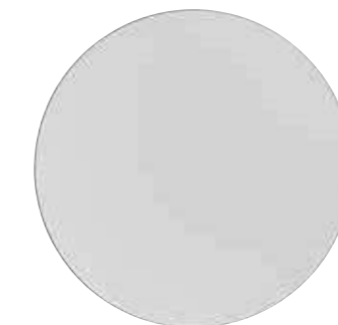

Piani tavoli in stratificato 10 mm /  
10 mm compact laminate table tops /  
Plateau en stratifié compact 10 mm /  
Mehrschicht Platte für Außenbereich Stärke 10 mm /  
Sobres de mesas en estratificado 10 mm

### full colour

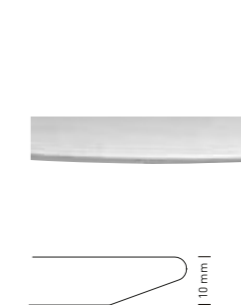
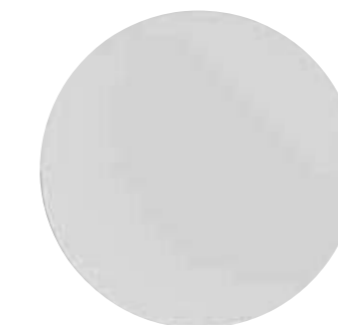

Piani tavoli in stratificato 10 mm /  
10 mm compact laminate table tops /  
Plateau en stratifié compact 10 mm /  
Mehrschicht Platte für Außenbereich Stärke 10 mm /  
Sobres de mesas en estratificado 10 mm



finiture sedute /  
seating finishes /  
finitions des sièges /  
sitzfertigungen /  
acabados asientos

materiale plastico /  
plastic material / matériel plastic /  
kunststoff / material plástico

PA

poliammide / polyamide / polyamide / polyamid / poliamida



flint

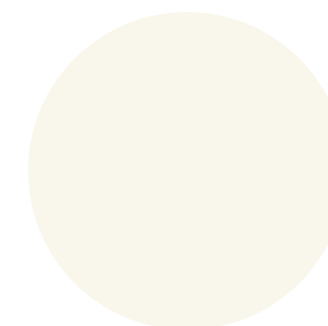

NCS S0500-N  
Bianco puro / Pure  
white / Blanc pur /  
Reinweiß / Blanco puro

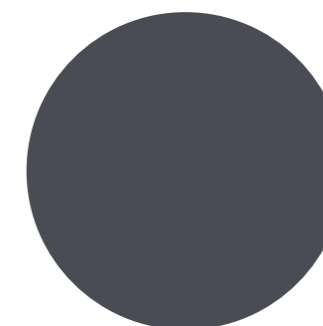

NCS S7502-B  
Grigio antracite /  
Anthracite grey /  
Gris anthracite /  
Anthrazitgrau /  
Gris antracita

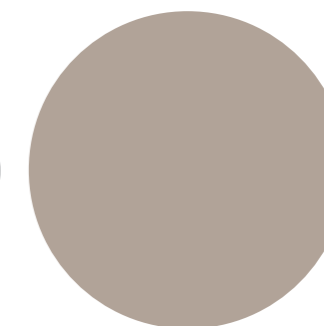

NCS S4005-Y20R  
Tortora / Turtle-dove /  
Gris tourterelle /  
Taubengrau / Tortora

PE

polietilene rotazionale / roto-moulding polyethylene /  
polyéthylène moulé à rotation / rotationsverfahren  
gepresstem polyäthylen / polietileno moldeado rotativo



apple /  
boom

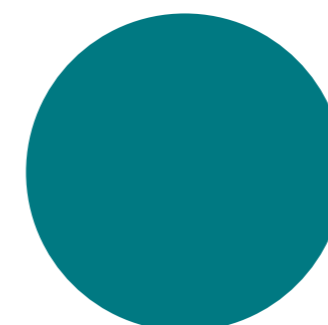

NCS S4050-B40G  
Blu acqua / Water blue /  
Bleu d'eau / Wasserblau /  
Azul agua

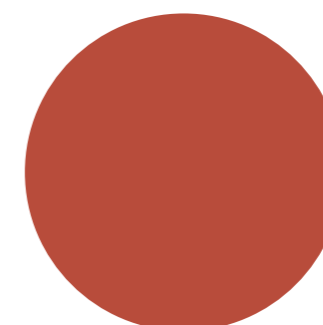

NCS S3060-Y80R  
Rosso corallo /  
Coral red / Rouge  
corail / Korallenrot /  
Rojo coral

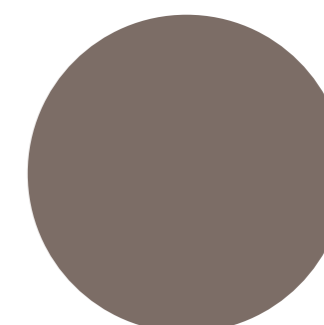

NCS S6502-R  
Argilla / Clay / Argile /  
Ton / Arcilla

playa



NCS S0500-N  
Bianco puro /  
Pure white /  
Blanc pur / Reinweiß /  
Blanco puro

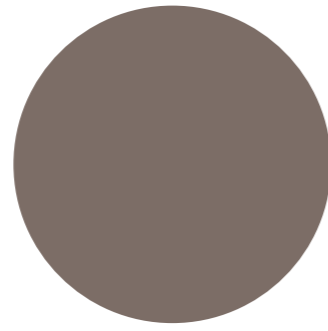

NCS S6502-R  
Argilla / Clay / Argile /  
Ton / Arcilla

pif

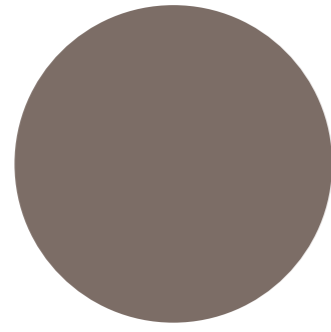

NCS S6502-R  
Argilla / Clay / Argile /  
Ton / Arcilla

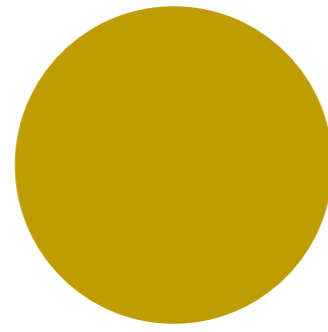

NCS S3060-Y  
Giallo curry / Curry /  
Jaune curry /  
Currygelb /  
Amarillo curry

PP

polipropilene / polypropylene /  
polypropylène / polypropylen / polipropileno



bikini



NCS S0500-N  
Bianco puro /  
Pure white /  
Blanc pur / Reinweiß /  
Blanco puro

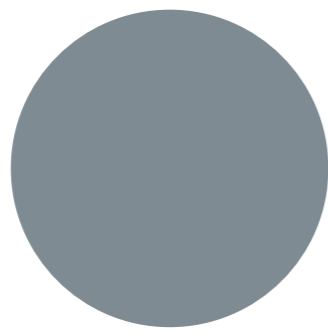

NCS S4005-B20G  
Grigio vaio / Squirrel  
grey / Gris petit-gris /  
Fehgrau / Gris ardilla

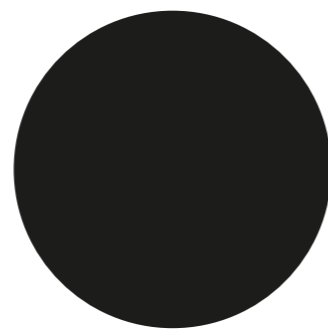

NCS S9000-N  
Nero intenso / Jet black /  
Noir foncé / Tiefschwarz /  
Negro intenso

classy



NCS S0502-B  
Bianco traffico /  
Traffic white /  
Blanc signalisation /  
Verkehrsweiß /  
Blanco tráfico

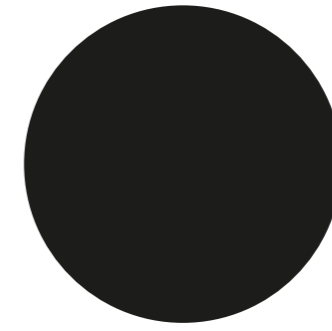

NCS S9000-N  
Nero intenso / Jet  
black / Noir foncé /  
Tiefschwarz /  
Negro intenso

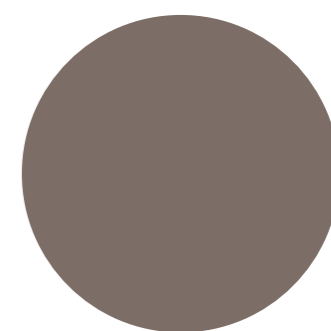

NCS S6502-R  
Argilla / Clay / Argile /  
Ton / Arcilla

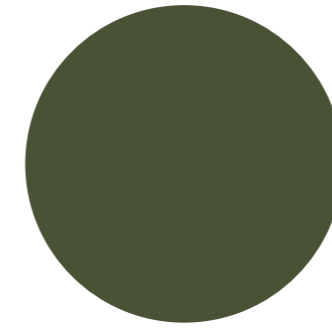

NCS S7020-G50Y  
Verde oliva /  
Olive green /  
Vert olive /  
Olivgrün /  
Verde aceituna

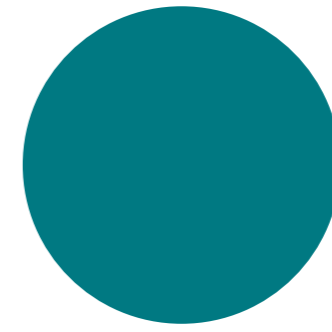

NCS S4050-B40G  
Blu acqua / Water blue /  
Bleu d'eau / Wasserblau /  
Azúl agua

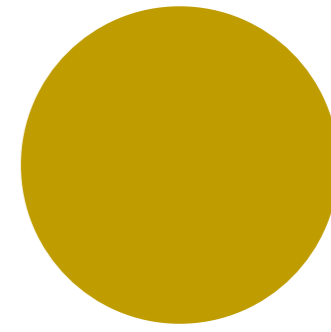

NCS S3060-Y  
Giallo curry / Curry /  
Jaune curry / Currygelb /  
Amarillo curry

cuba



NCS S0500-N  
Bianco puro /  
Pure white /  
Blanc pur / Reinweiß /  
Blanco puro

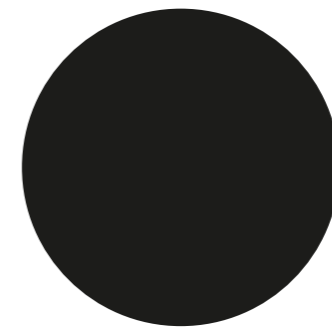

NCS S9000-N  
Nero intenso / Jet  
black / Noir foncé /  
Tiefschwarz /  
Negro intenso

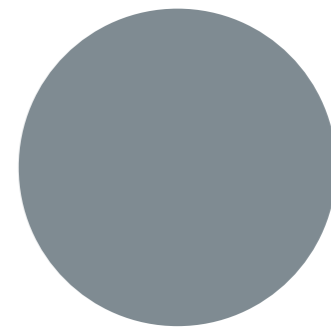

NCS S4005-B20G  
Grigio vaio / Squirrel  
grey / Gris petit-gris /  
Fehgrau / Gris ardilla

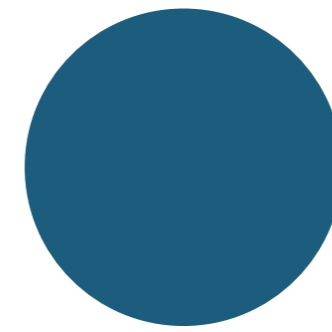

NCS S6030-B  
Blu capri / Capri blue /  
Bleu capri / Blau Capri /  
Azúl capri

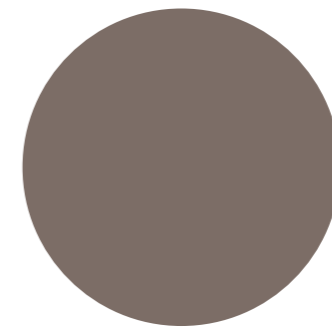

NCS S6502-R  
Argilla / Clay / Argile /  
Ton / Arcilla

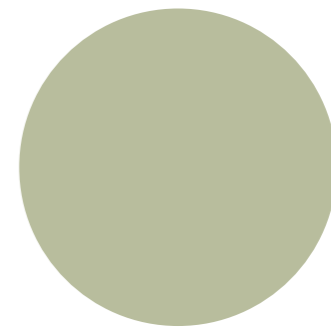

NCS S3010-G50Y  
Pistacchio /  
Pistachio / Pistache /  
Pistazie / Pistacho

maré



NCS S0500-N  
Bianco puro / Pure  
white / Blanc pur /  
Reinweiß / Blanco puro

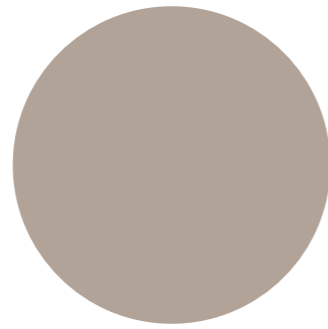

NCS S4005-Y20R  
Tortora / Turtle-dove /  
Gris tourterelle /  
Taubengrau / Tortora

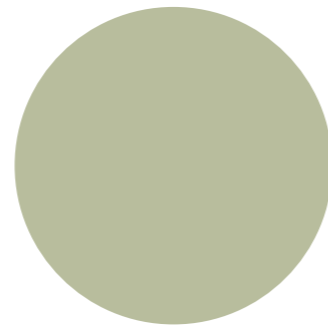

NCS S3010-G50Y  
Pistacchio /  
Pistachio / Pistache /  
Pistazie / Pistacho

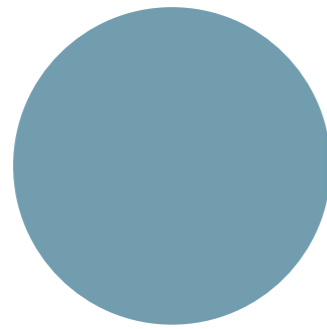

NCS S4020-B10G  
Blu polvere / Dusty  
blue / Bleu poudre /  
Stauben Blau / Azul  
polvo

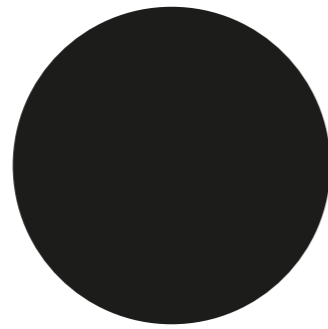

NCS S9000-N  
Nero intenso / Jet  
black / Noir foncé /  
Tiefschwarz /  
Negro intenso

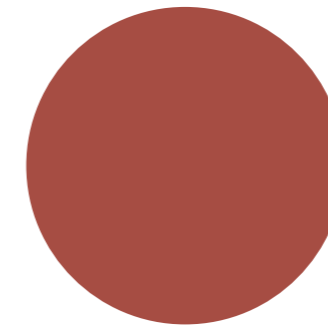

NCS S4040-R  
Marsala / Marsala /  
Marsala / Marsala /  
Marsala

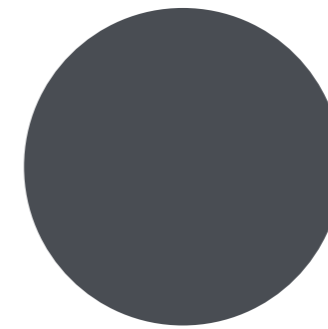

NCS S7502-B  
Grigio antracite / Anthracite  
grey / Gris anthracite /  
Anthrazitgrau / Gris antracita

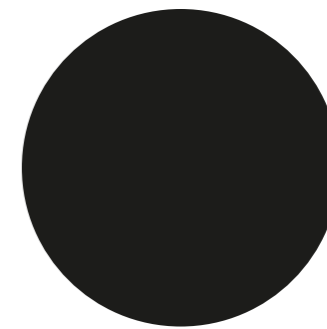

NCS S9000-N  
Nero intenso / Jet black /  
Noir foncé / Tiefschwarz /  
Negro intenso

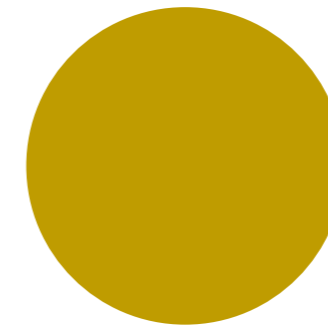

NCS S3060-Y  
Giallo curry / Curry /  
Jaune curry /  
Currygelb /  
Amarillo curry

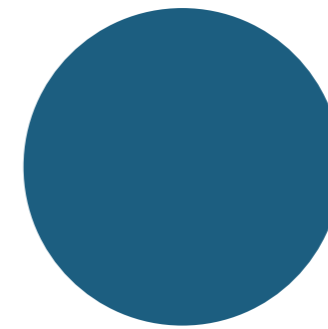

NCS S6030-B  
Blu capri / Capri blue /  
Bleu capri / Blau Capri /  
Azul capri



NCS S3050-G60Y  
Verde felce / Fern green /  
Vert fougère / Farngrün /  
Verde helecho

nassau



537

non disponibile nel colore / not available in colour / pas disponible dans la couleur / nicht verfügbar in die Farbe / non disponible en el color:  
Grigio vaio / Squirrel grey / Gris petit-gris / Fehgrau / Gris ardilla

537B

non disponibile nei colori / not available in the following colors / pas disponible dans les couleurs / nicht verfügbar in die Farben / non disponible en los colores:  
Blu capri / Capri blue / Bleu capri / Blau Capri / Azul capri, Giallo curry / Curry / Jaune curry / Currygelb / Amarillo curry, Grigio vaio / Squirrel grey / Gris petit-gris / Fehgrau / Gris ardilla, Verde felce / Fern green / Vert fougère / Farngrün / Verdehelecho

Versione ignifuga disponibile solo nel colore / Fire retardant version available in the colour / Version ignifugé disponible en couleur / Schwer entflammbar Ausführung verfügbar in den Farbe / Versión ignifuga disponible solamente en color:  
NCS S0500-N Bianco puro / Pure white / Blanc pur / Reinweiß / Blanco puro



NCS S0500-N  
Bianco puro / Pure  
white / Blanc pur /  
Reinweiß / Blanco puro

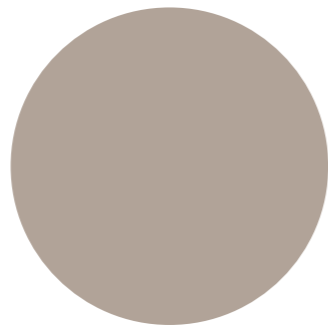

NCS S4005-Y50R  
Tortora / Turtle-dove /  
Gris tourterelle /  
Taubengrau / Tortora

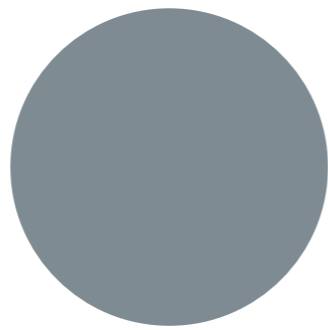

NCS S4005-B20G  
Grigio vaio / Squirrel  
grey / Gris petit-gris /  
Fehgrau / Gris ardilla

palau



NCS S0500-N  
Bianco puro / Pure  
white / Blanc pur /  
Reinweiß / Blanco puro

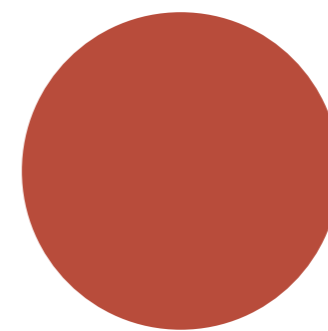

NCS S3060-Y80R  
Rosso corallo /  
Coral red / Rouge  
corail / Korallenrot /  
Rojo coral

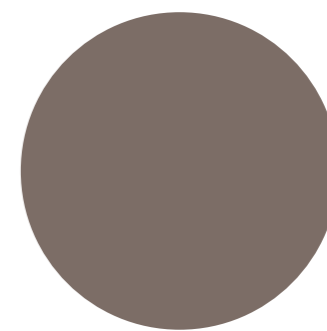

NCS S6502-R  
Argilla / Clay / Argile /  
Ton / Arcilla

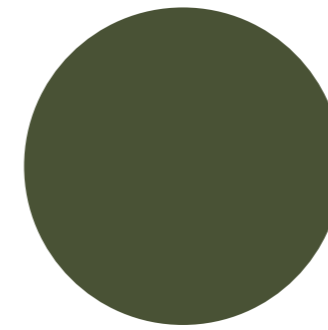

NCS S7020-G50Y  
Verde oliva / Olive  
green / Vert olive /  
Olivgrün / Verde oliva

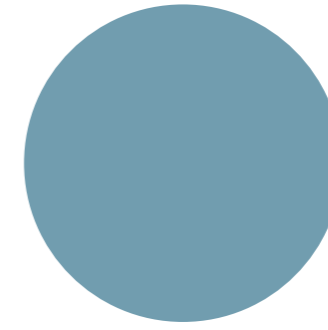

NCS S4020-B10G  
Blu polvere / Dusty  
blue / Bleu poudre /  
Stauben Blau /  
Azul polvo

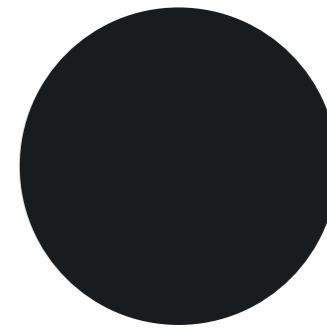

NCS S9000-N  
Nero intenso / Jet black /  
Noir foncé / Tiefschwarz /  
Negro intenso



snap



NCS S0502-B  
Bianco traffico / Traffic white / Blanc signalisation / Verkehrsweiß / Blanco tráfico

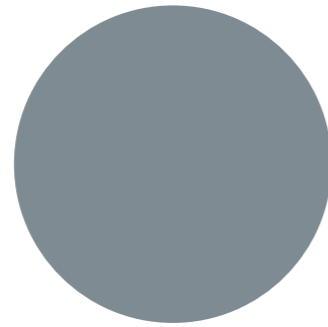

NCS S4005-B20G  
Grigio vaio / Squirrel grey / Gris petit-gris / Fehgrau / Gris ardilla

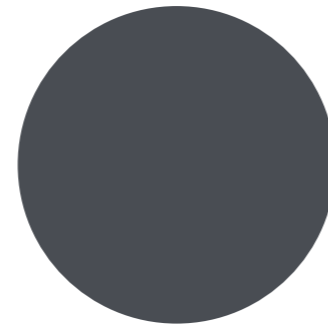

NCS S7502-B  
Grigio antracite / Anthracite grey / Gris anthracite / Anthrazitgrau / Gris antracita

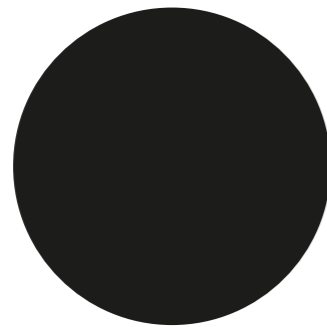

NCS S9000-N  
Nero intenso / Jet black / Noir foncé / Tiefschwarz / Negro intenso

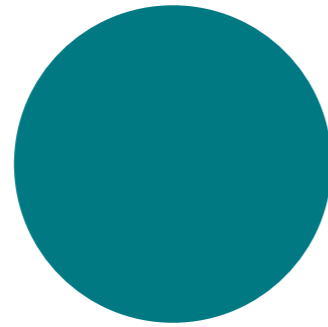

NCS S4050-B40G  
Blu acqua / Water blue / Bleu d'eau / Wasserblau / Azul agua

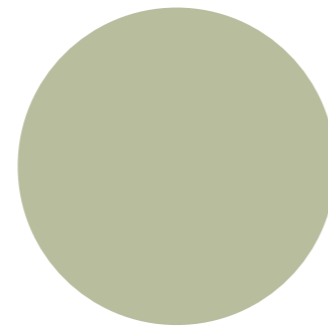

NCS S3010-G50Y  
Pistacchio / Pistachio / Pistache / Pistazie / Pistacho

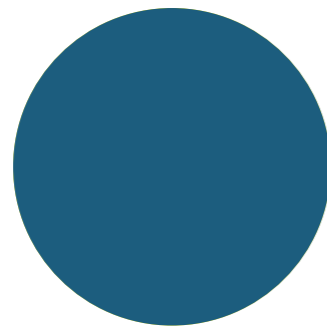

NCS S6030-B  
Blu capri / Capri blue / Bleu capri / Blau Capri / Azul capri

uni



NCS S0502-B  
Bianco traffico / Traffic white / Blanc signalisation / Verkehrsweiß / Blanco tráfico

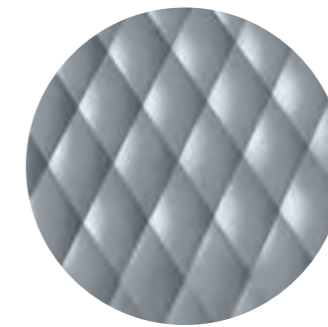

NCS S4005-B20G  
Grigio vaio / Squirrel grey / Gris petit-gris / Fehgrau / Gris ardilla

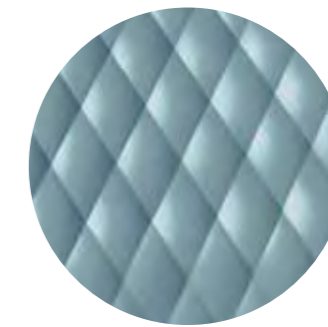

NCS S4020-B10G  
Blu polvere / Dusty blue / Bleu poudre / Stauben Blau / Azul polvo

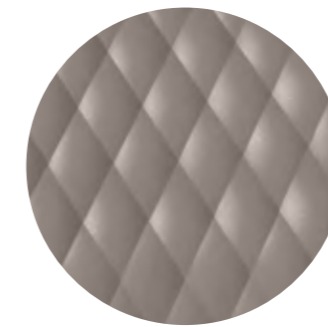

NCS S6502-R  
Argilla / Clay / Argile / Ton / Arcilla

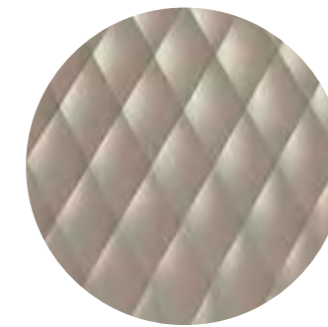

NCS S4005-Y50R  
Tortora / Turtle-dove / Gris tourterelle / Taubengrau / Tortora

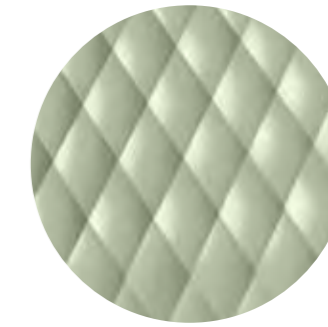

NCS S3010-G50Y  
Pistacchio / Pistachio / Pistache / Pistazie / Pistacho



NCS S9000-N  
Nero intenso / Jet black / Noir foncé / Tiefschwarz / Negro intenso

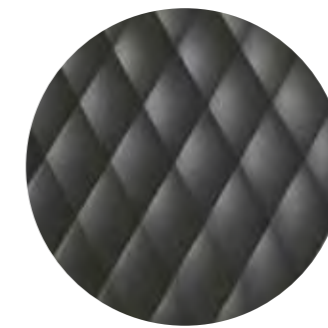

NCS S7502-B  
Grigio antracite / Anthracite grey / Gris anthracite / Anthrazitgrau / Gris antracita

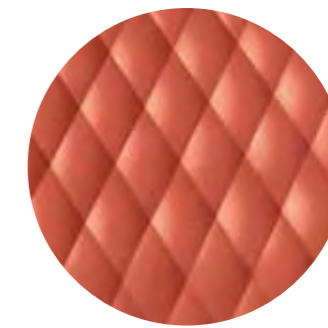

NCS S3060-Y80R  
Rosso corallo / Coral red / Rouge corail / Korallenrot / Rojo coral



NCS S3060-Y  
Giallo curry / Curry / Jaune curry / Currygelb / Amarillo curry

uni-ka



NCS S0502-B  
Bianco traffico / Traffic  
white / Blanc signalisation /  
Verkehrsweiß /  
Blanco tráfico

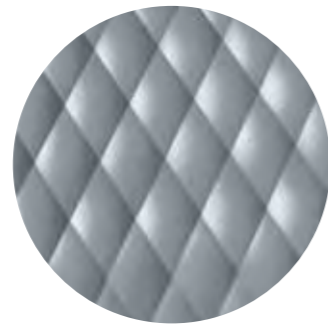

NCS S4005-B20G  
Grigio vaio / Squirrel  
grey / Gris petit-gris /  
Fehgrau / Gris ardilla

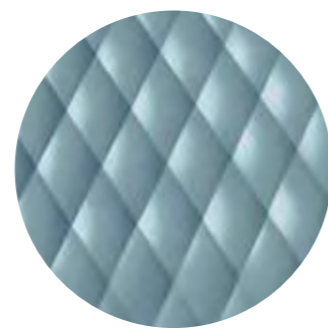

NCS S4020-B10G  
Blu polvere / Dusty blue /  
Bleu poudre / Stauben  
Blau / Azúl polvo

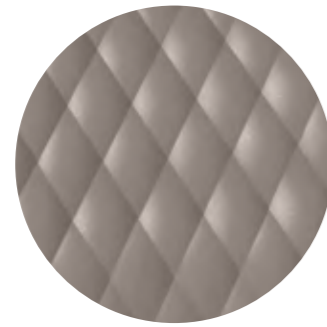

NCS S6502-R  
Argilla / Clay / Argile /  
Ton / Arcilla



NCS S4005-Y50R  
Tortora / Turtle-dove /  
Gris tourterelle /  
Taubengrau / Tortora

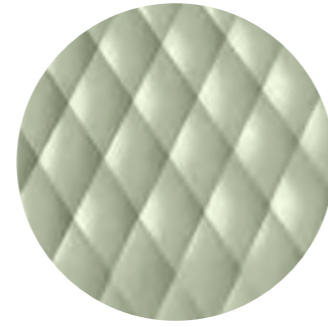

NCS S3010-G50Y  
Pistacchio /  
Pistachio / Pistache /  
Pistazie / Pistacho



NCS S9000-N  
Nero intenso /  
Jet black / Noir foncé  
Tiefschwarz / Negro  
intenso



NCS S7502-B  
Grigio antracite /  
Anthracite grey / Gris  
anthracite / Anthrazitgrau /  
Gris antracita



NCS S3060-Y80R  
Rosso corallo /  
Coral red / Rouge corail /  
Korallenrot / Rojo coral



NCS S3060-Y  
Giallo curry / Curry /  
Jaune curry / Currygelb /  
Amarillo curry

PP +  
PET

tecnopolimero composito multistrato a densità variabile / technopolymer, multi-layer  
variable density / techno-polymère composite multicouche à densité variable /  
zusammengesetztes mehrschichtiges technopolymere mit wechselbarer dichte /  
tecnopolimero compuesto multicapas de densidad variable



echo

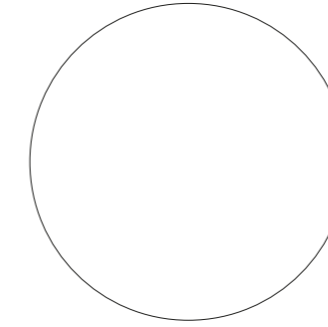

NCS S0502-B  
Bianco traffico / Traffic  
white / Blanc signalisation /  
Verkehrsweiß / Blanco  
tráfico

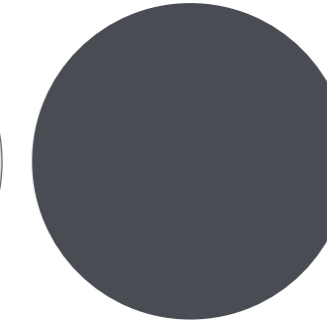

NCS S7502-B  
Grigio antracite /  
Anthracite grey / Gris  
anthracite / Anthrazitgrau /  
Gris antracita

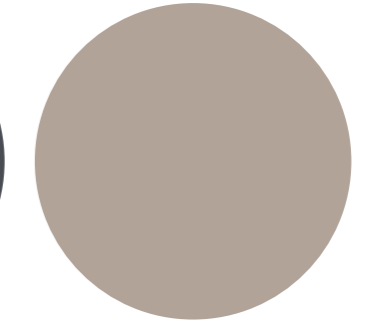

NCS S4005-Y20R  
Tortora / Turtle-Dove /  
Gris Tourterelle /  
Taubengrau / Tortora

ibis

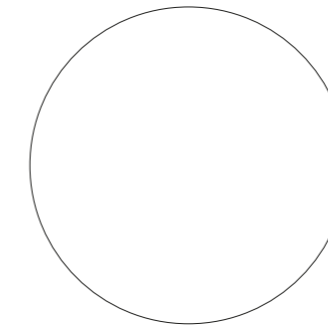

NCS S0502-B  
Bianco traffico / Traffic  
white / Blanc signalisation /  
Verkehrsweiß / Blanco  
tráfico

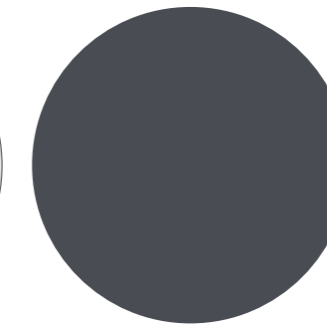

NCS S7502-B  
Grigio antracite /  
Anthracite grey / Gris  
anthracite / Anthrazitgrau /  
Gris antracita

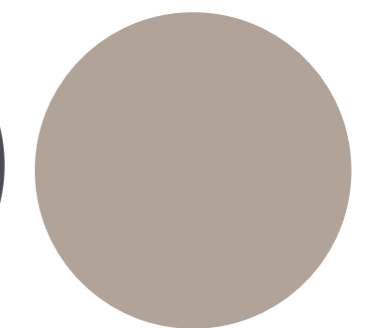

NCS S4005-Y20R  
Tortora / Turtle-Dove /  
Gris Tourterelle /  
Taubengrau / Tortora

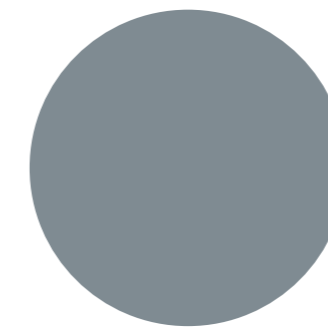

NCS S4005-B20G  
Grigio vaio / Squirrel  
grey / Gris spetit-gris /  
Fehgrau / Gris ardilla

001



Bianco / White /  
Blanc / Weiss / Blanco



Nero 1 / Black 1 /  
Noir 1 / Schwarz 1 / Negro 1

LE

**hull\* /  
duo /  
luna**

\* finitura gofrata /  
embossed finish /  
finition gofré /  
geprägte Ausführung /  
acabado gofrado



Faggio tinto miele /  
Honey stained  
beech wood / Hêtre  
teinté miel / Buche  
Honig gefärbt / Haya  
tenida miel

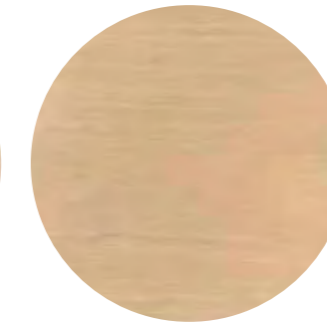

Faggio tinto castano /  
Chestnut stained beech  
wood / Hêtre teinté  
châtaigne / Buche  
Kastanie gefärbt /  
Haya tenida castaño



Faggio tinto grigio /  
Grey stained beech  
wood / Hêtre teinté  
gris / Buche Grau  
gefärbt / Haya tenida  
gris

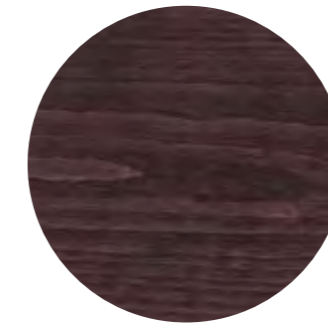

Faggio tinto bruno /  
dark brown stained  
beech wood / Hêtre  
teinté brun / Buche  
Dunkel braun gefärbt /  
Haya tenida pardo



Faggio tinto nero /  
Black stained beech  
wood / Hêtre teinté  
noir / Buche  
Schwarz gefärbt /  
Haya tenida negro

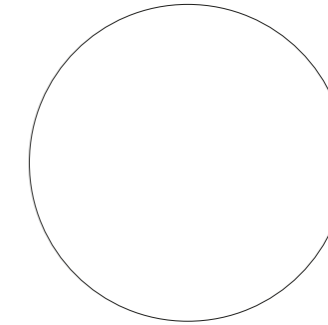

Faggio tinto campione / Beech wood,  
stained according to sample /  
Hêtre teinté selon échantillon /  
Kundenmuster gefärbt / Haya tenida  
según muestra

Ordine minimo 10 pz / Minimum order 10  
pcs / Minimum de commande 10 pièces /  
Mindestbestell 10 Stück / Minimo de  
compra 10 piezas



acciaio / steel / acier /  
stahl / acero

**AC**

Per finiture Shade, Net e Stripes, vedi colori disponibili a p. 397 / For Shade, Net and Stripes finishes, see available colours, p. 397 / Pour les finitions de Shade, Net et Stripes, couleurs disponibles à la p. 397 / Für Shade, Net und Stripes siehe Farben auf S. 397 / Para acabados Shade, Net y Stripes ver los colores disponibles en la p. 397

tessuti / fabrics / tissus /  
stoffe / tejidos

**TE**

**cat. a**

**fortis**

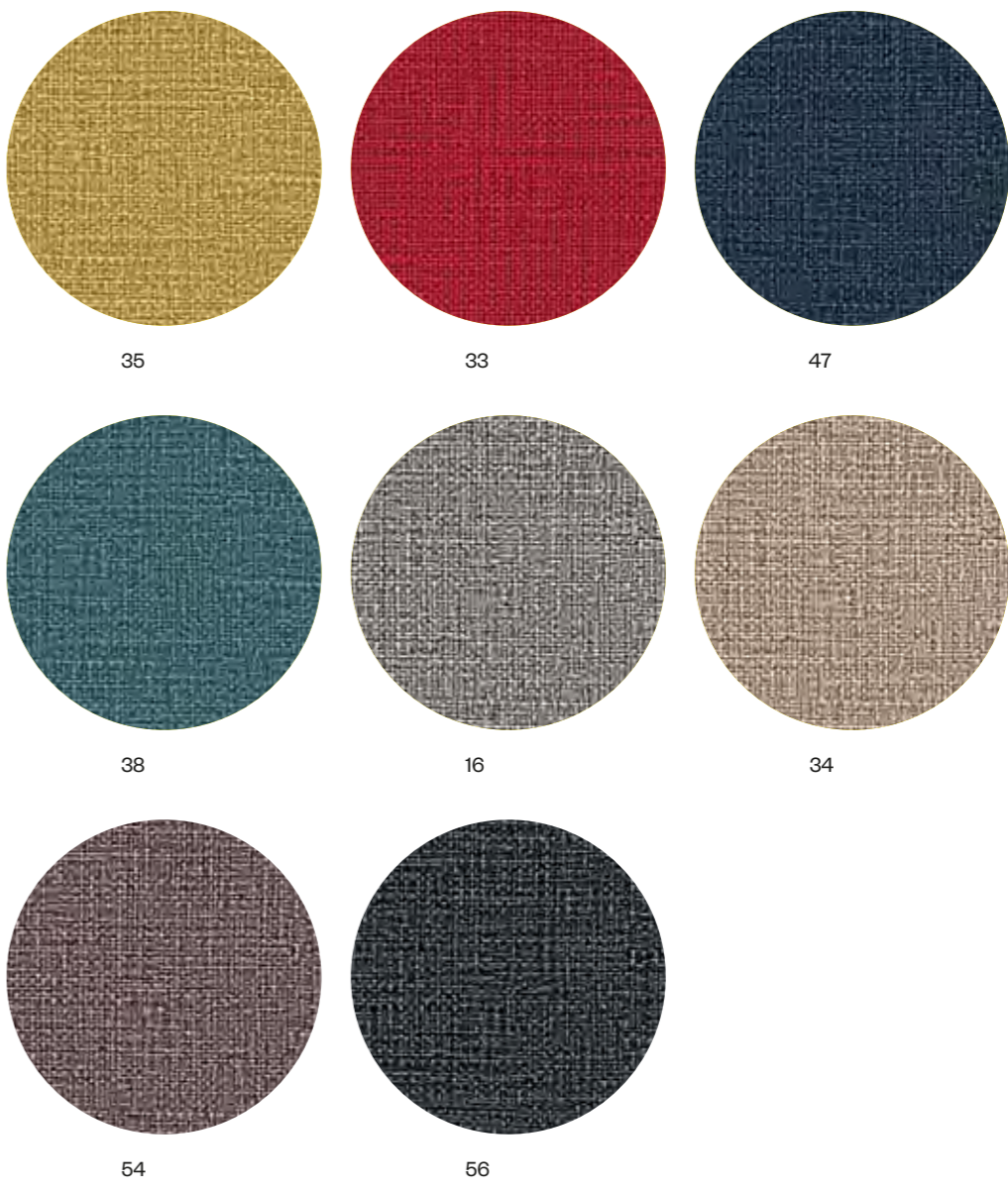

cat. a

melva



70

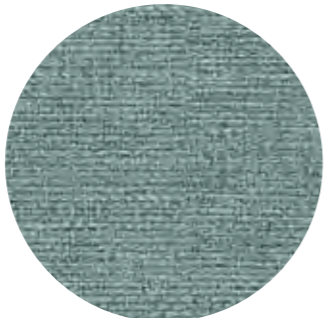

72



02



83



87



09



20



39



06



94

cat. b

amsterdam

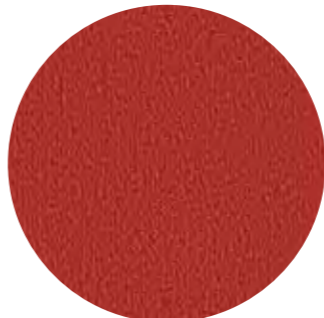

153



135

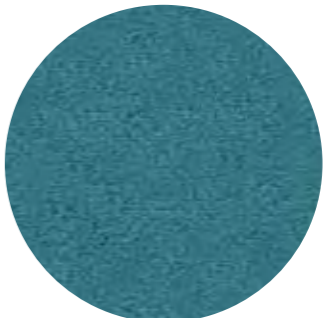

57

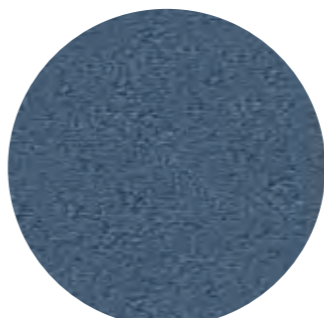

37



08



38



123



26



cat. **b**

**inca**

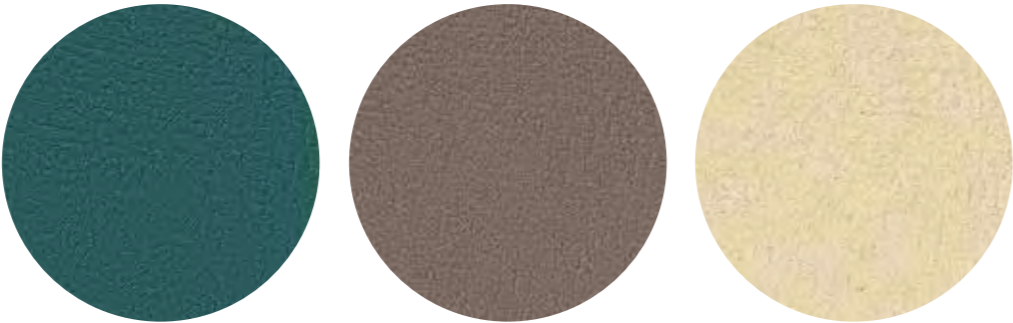

51

603

56



33

12

17

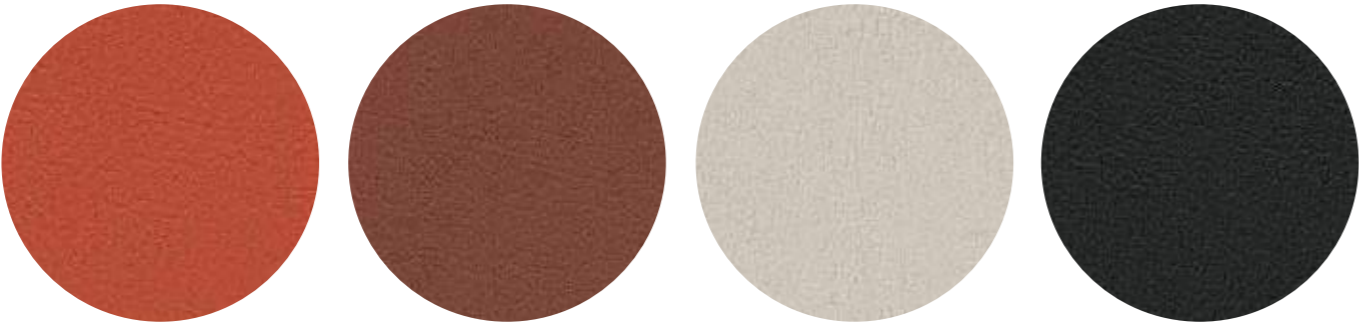

15

415

55

42

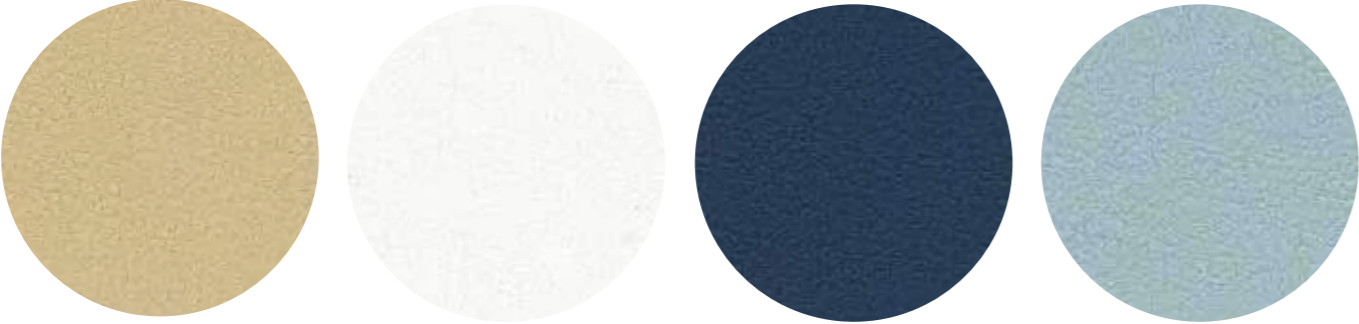

103

100

35

703

cat. **b**

**medley**  
gabriel

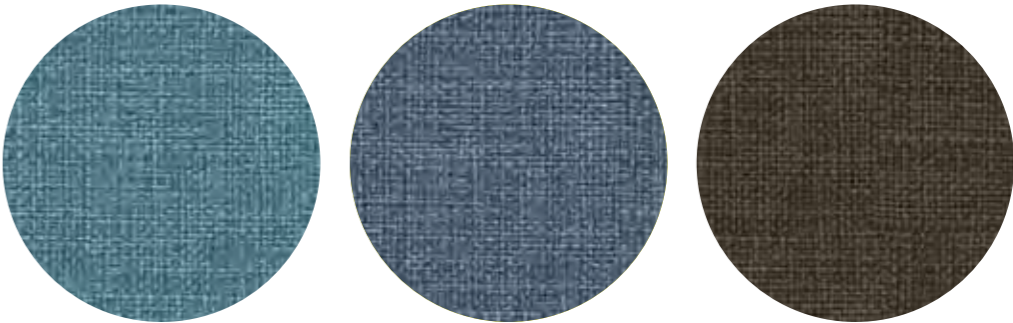

67006

66010

61004

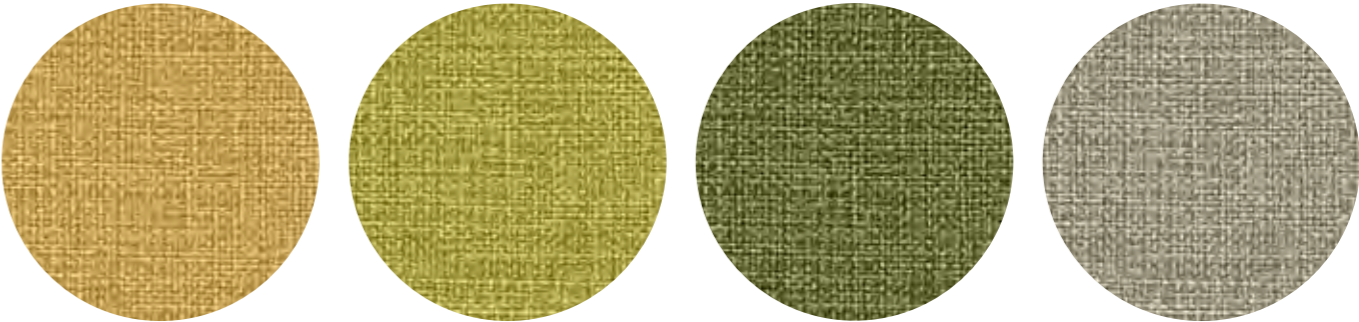

62054

68002

68005

61002

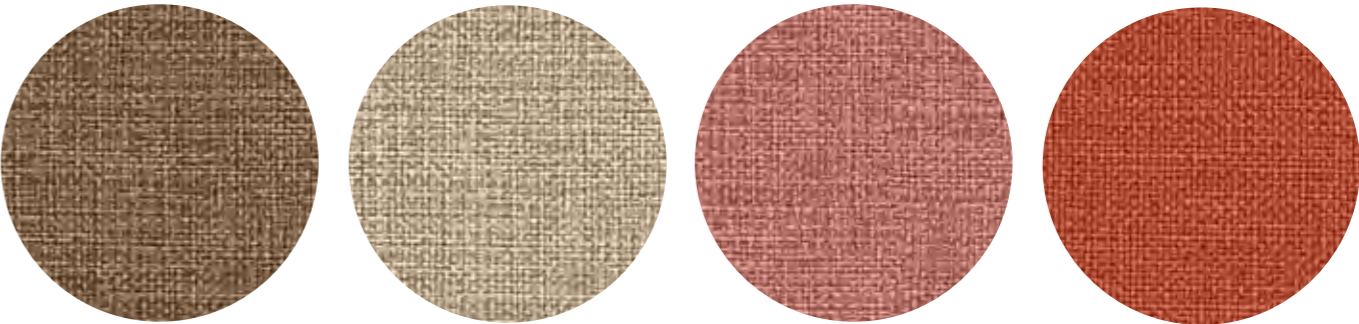

61003

61189

63064

63017

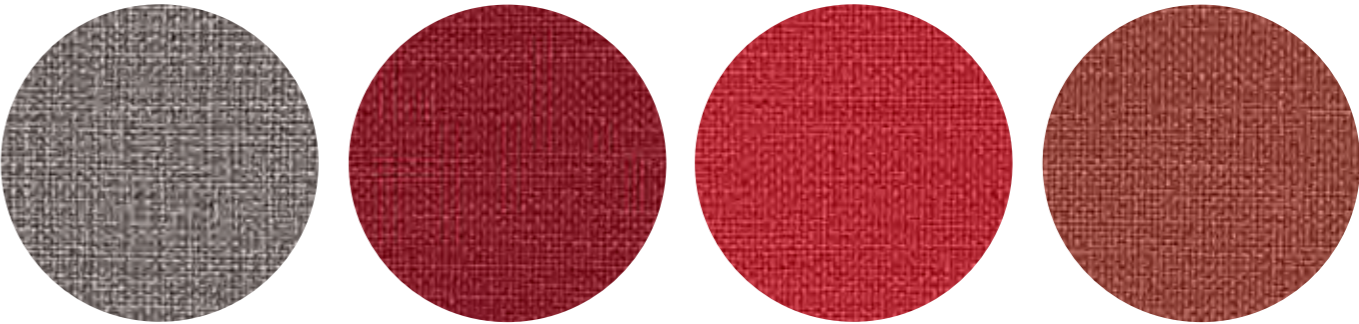

65011

64123

64019

63063



cat. **b**

mirage

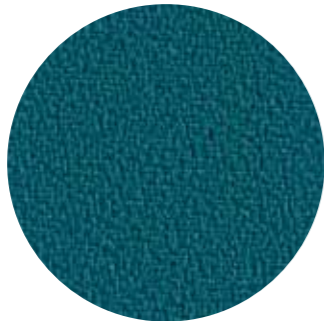

411



573



625



569



643

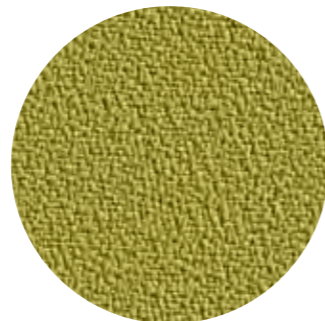

426

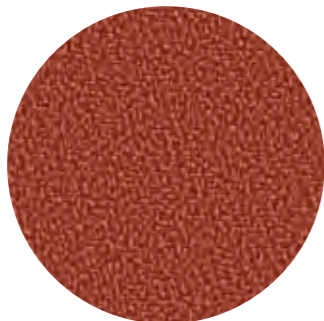

572



236

cat. **e** 

chili  
gabriel

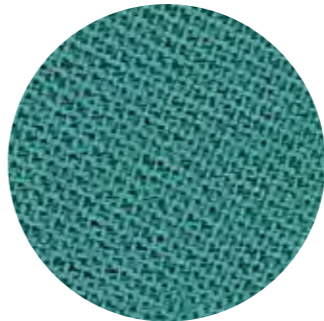

68190

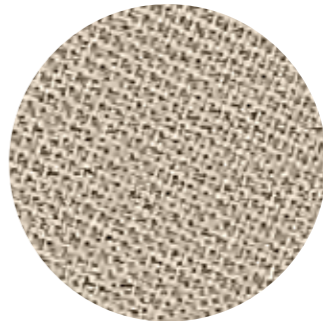

61174

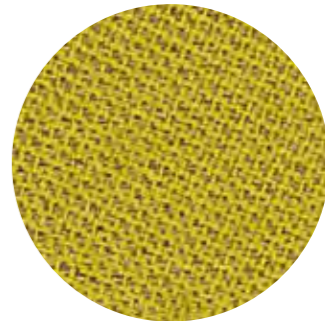

62085

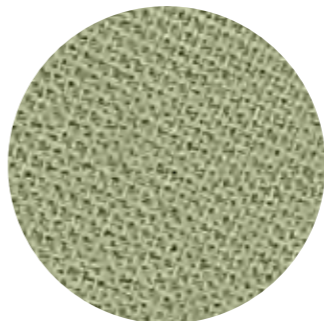

68195

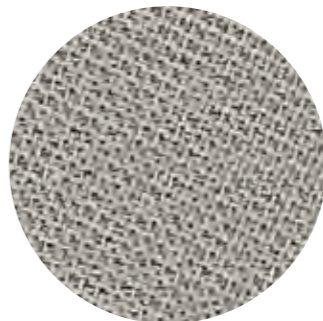

60115

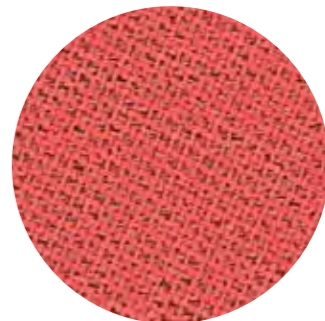

64199

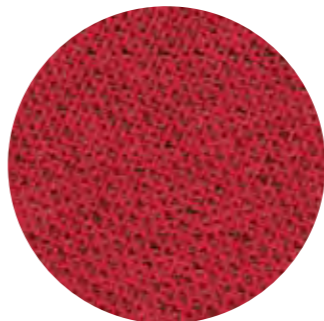

64201

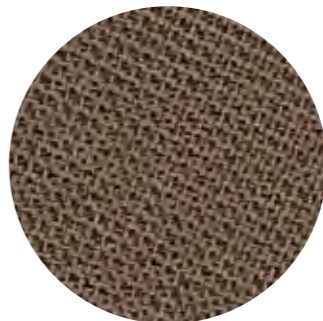

61175



**convert**

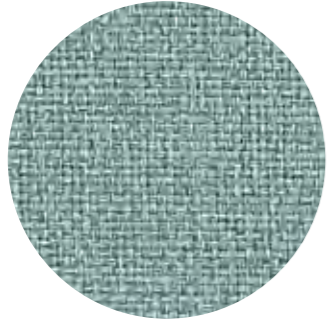

4467



4560



4511



4466

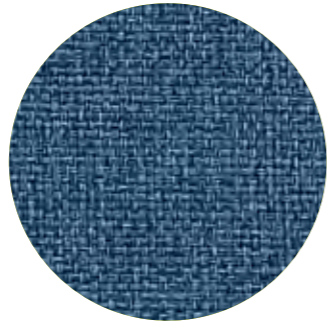

4313



4462



4056



4211

**fenice**

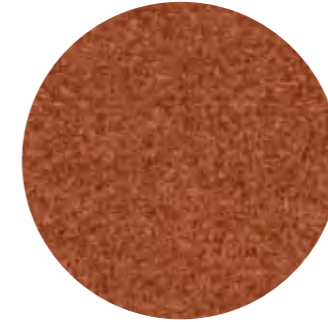

103



551



505



52



351

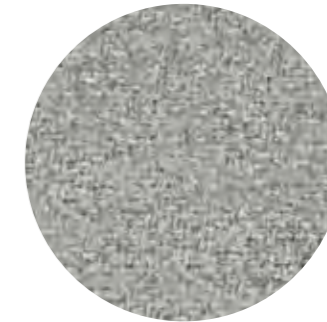

601

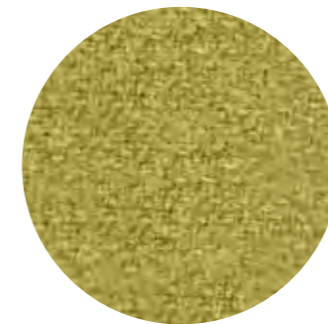

451

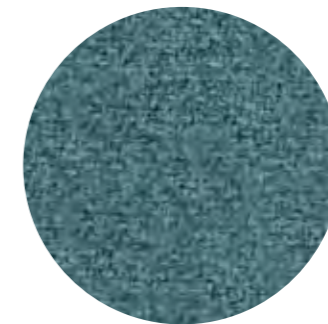

454



**in&out**

Non utilizzabile per  
Punto e To-Kyo/  
Not suitable for Punto  
and To-Kyo /  
Pas disponible pour  
Punto et To-Kyo /  
Nicht benutzbar für  
Punto und To-Kyo /  
No utilizable para  
Punto y To-Kyo.

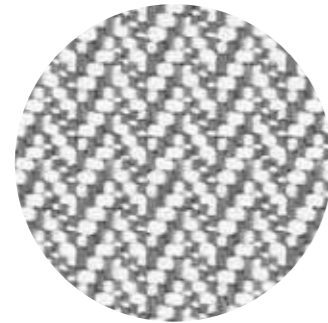

K600

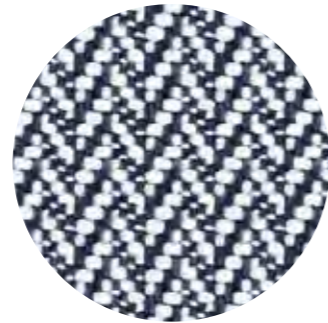

K700

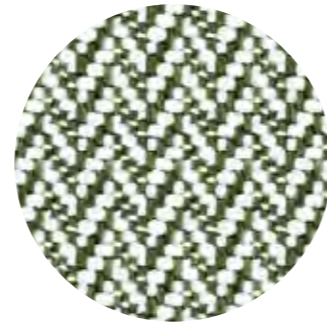

K800

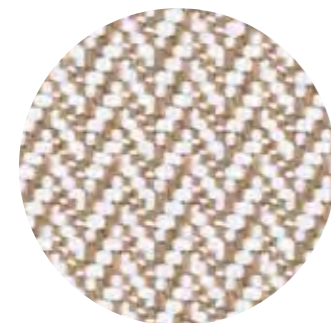

K400



K900

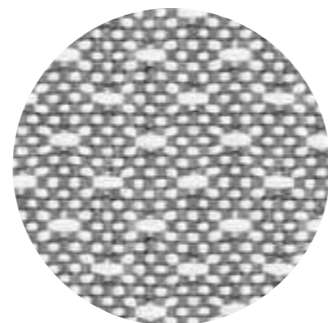

P600

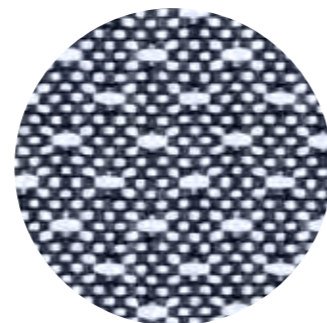

P700

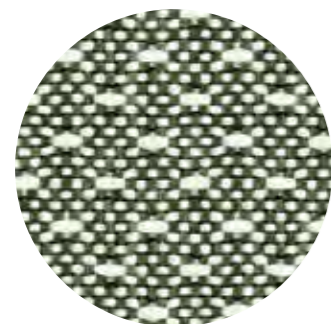

P800

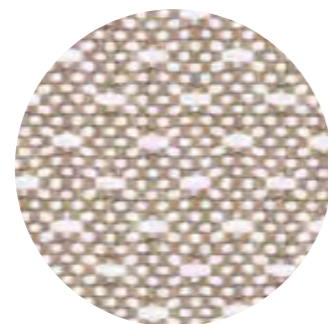

P400

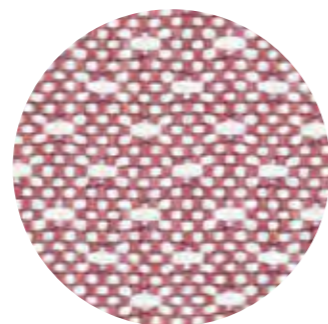

P900

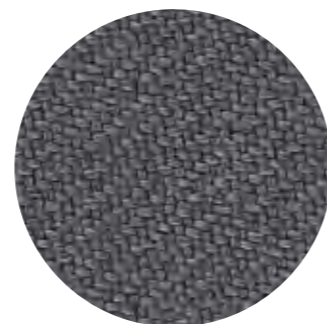

U600

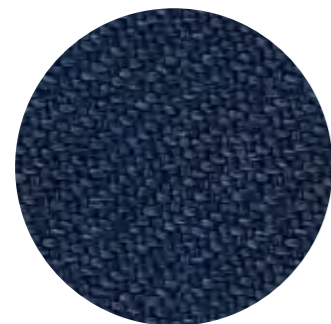

U700



U800

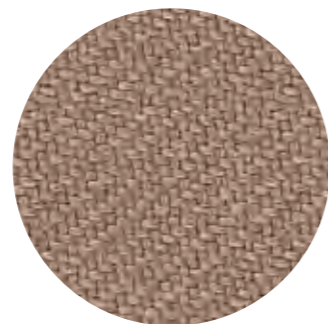

U400

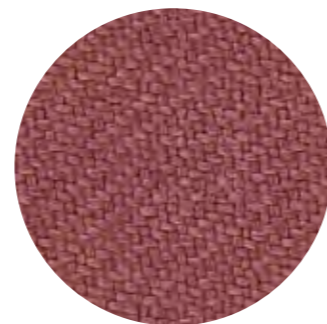

U900

**rondo  
gabriel**

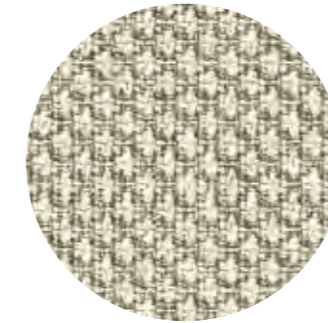

61200

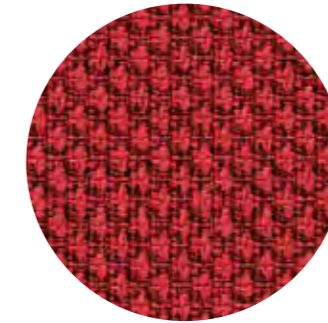

64226

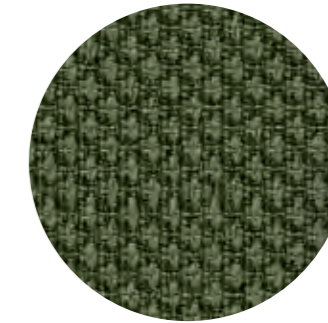

68226

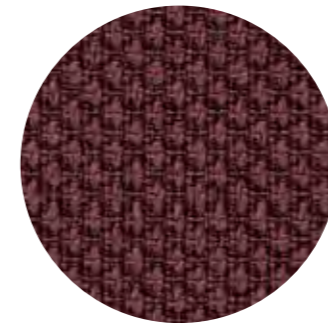

65220

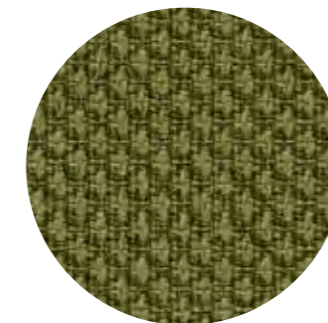

68225

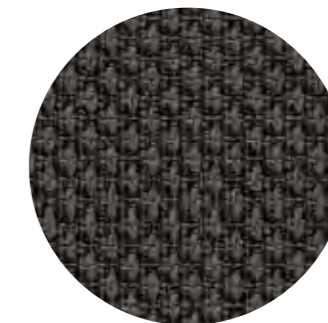

60144

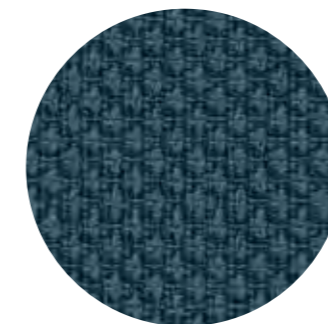

67097

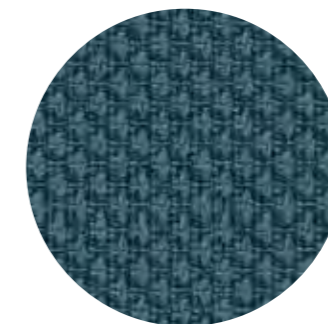

67112



cat. e

valencia



107-8032

107-1049

107-0035



107-9035

107-0020

107-2075

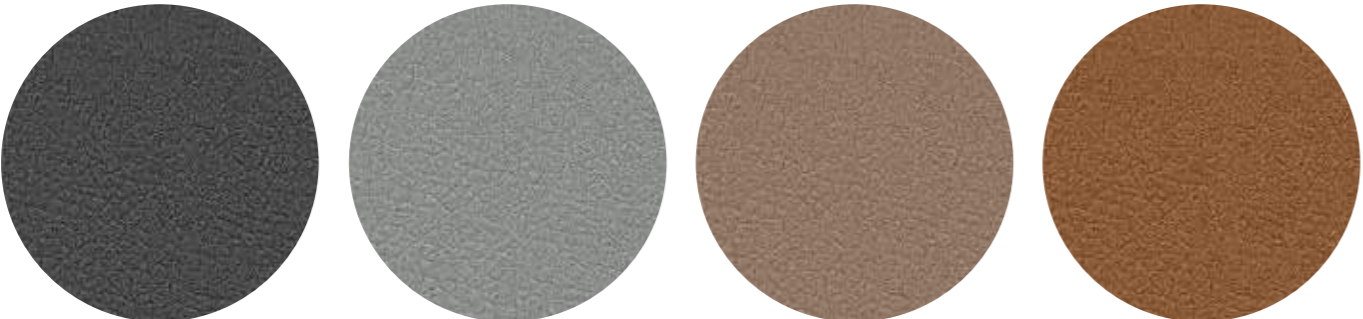

107-4003

107-4045

107-0034

107-0002

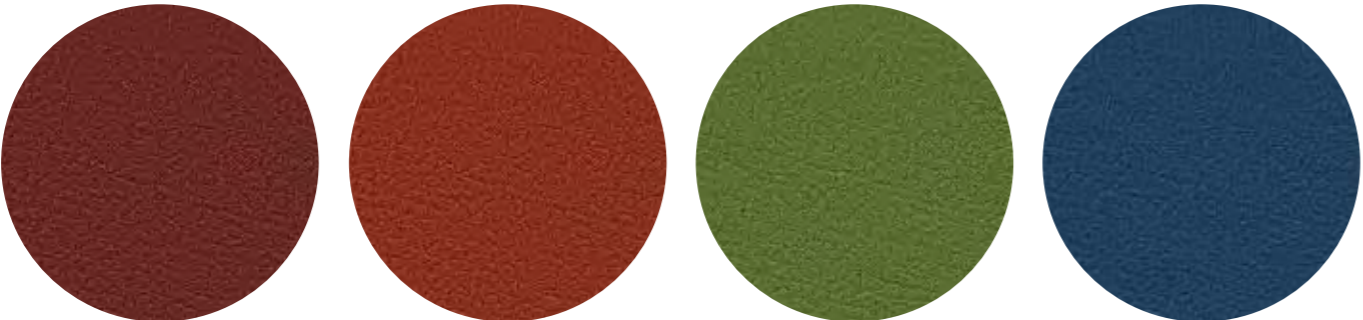

107-2062

107-2074

107-5001

107-3069

cat. g

mood  
gabriel



1101

4104

5102

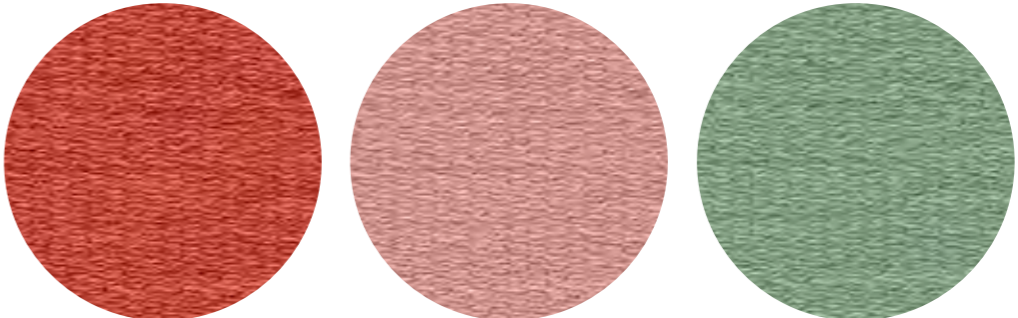

3102

1106

4106

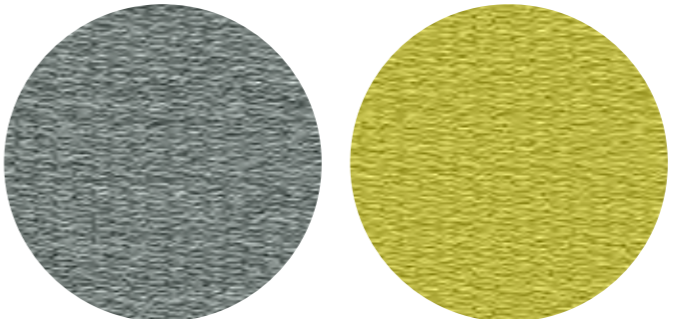

4105

3104



cat. g

**reviva**

Non utilizzabile per  
Punto e To-Kyo/  
Not suitable for Punto  
and To-Kyo /  
Pas disponible pour  
Punto et To-Kyo /  
Nicht benutzbar für  
Punto und To-Kyo /  
No utilizable para  
Punto y To-Kyo.

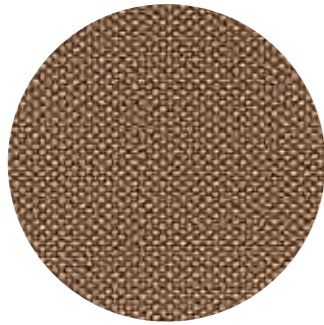

402

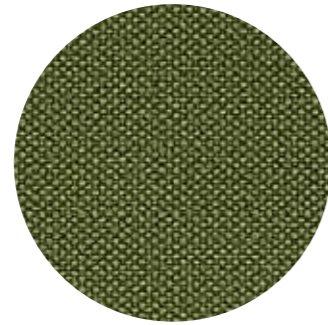

801

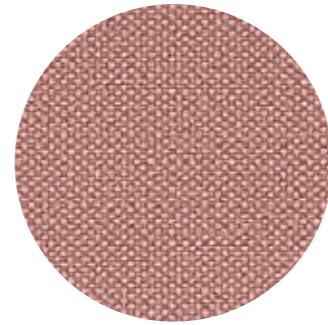

901

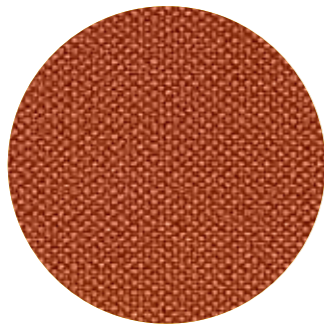

304

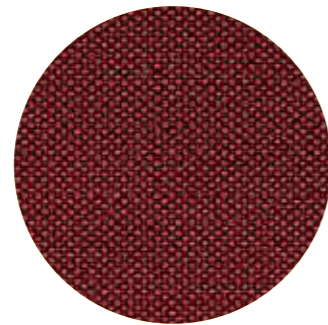

303

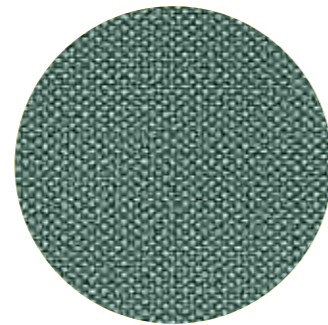

711

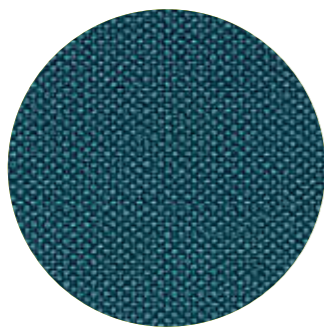

701

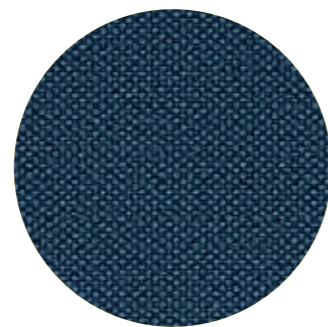

706

cat. l

**fabthirty**  
rubelli

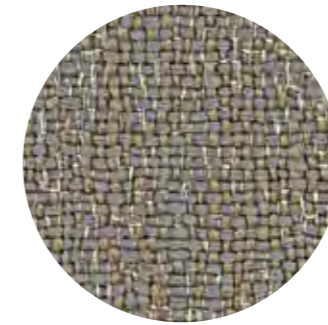

3019-5

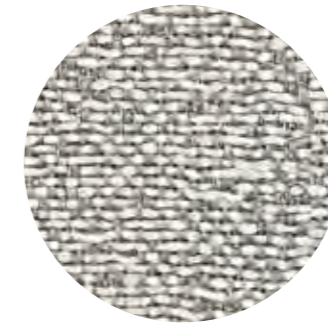

3019-8

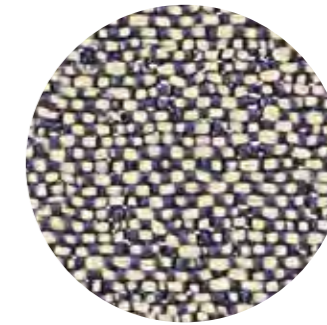

3019-9

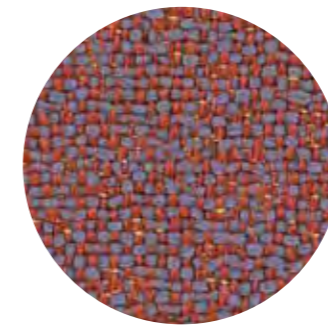

3019-14

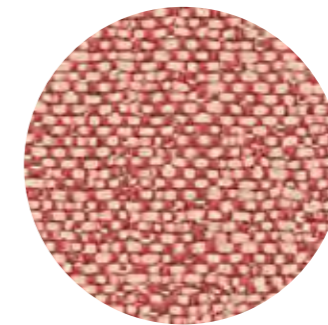

3019-15

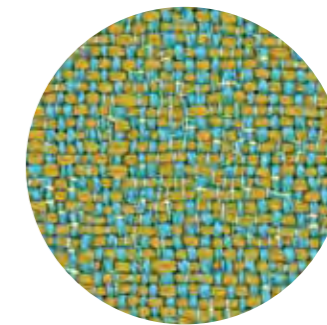

3019-20

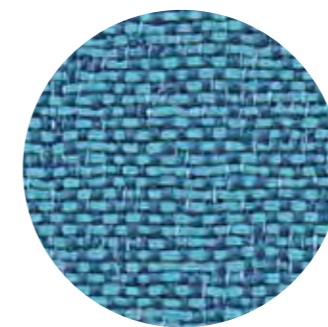

3019-23

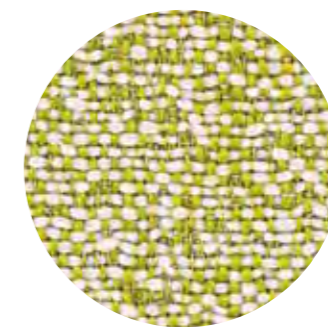

3019-18



cat. l

remix 3  
kvadrat



412

422

912

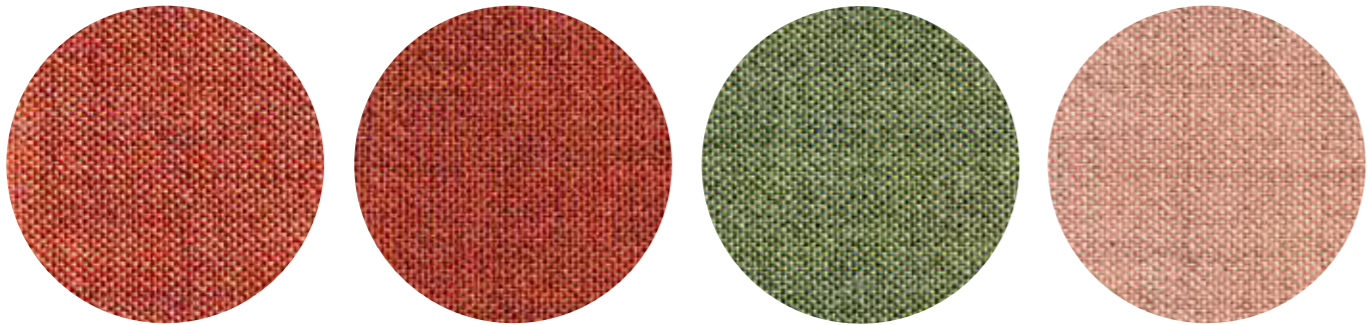

632

653

933

612

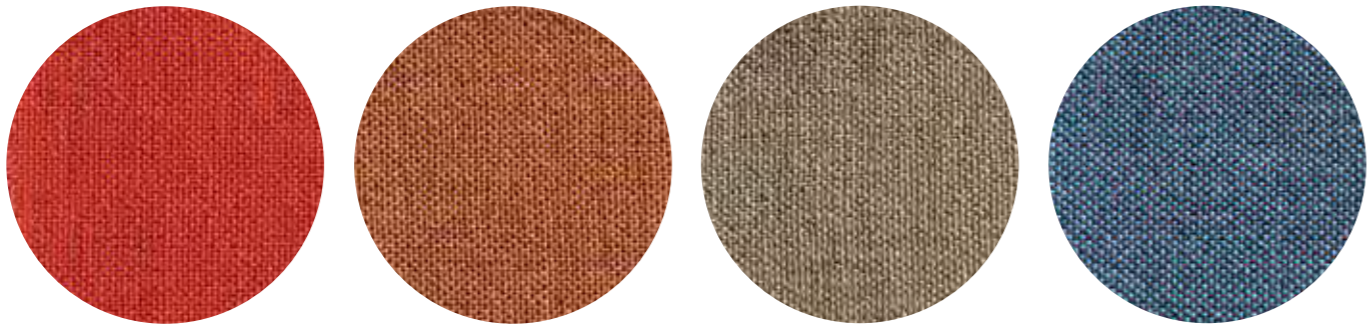

643

452

233

743

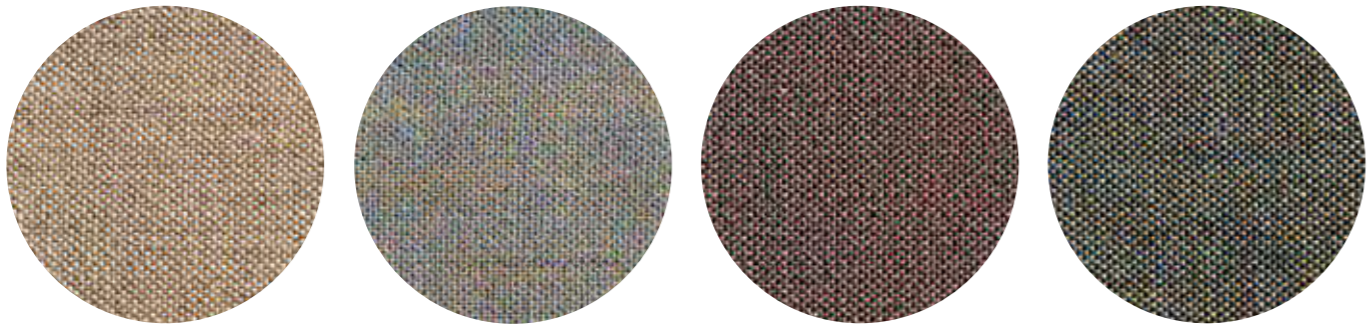

242

722

672

852

cat. m

ocean  
mastrotto

pelle / leather / peau /  
leder / piel



418

433

435

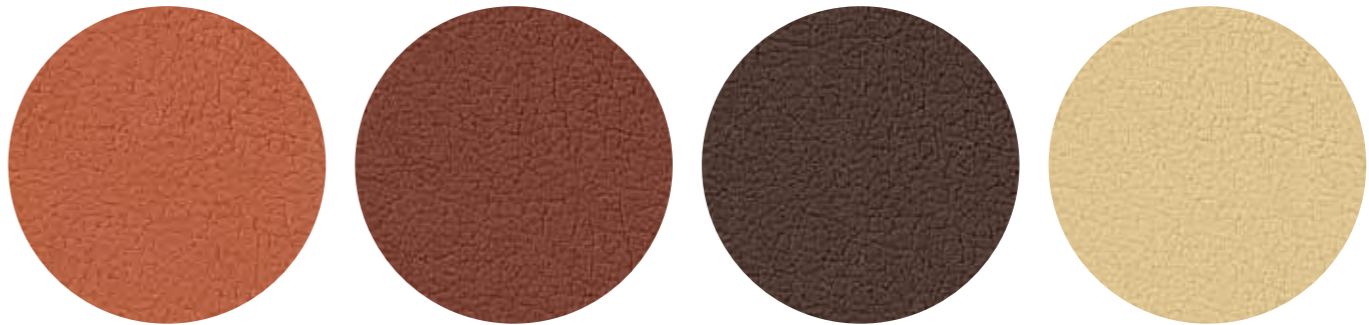

414

413

437

428

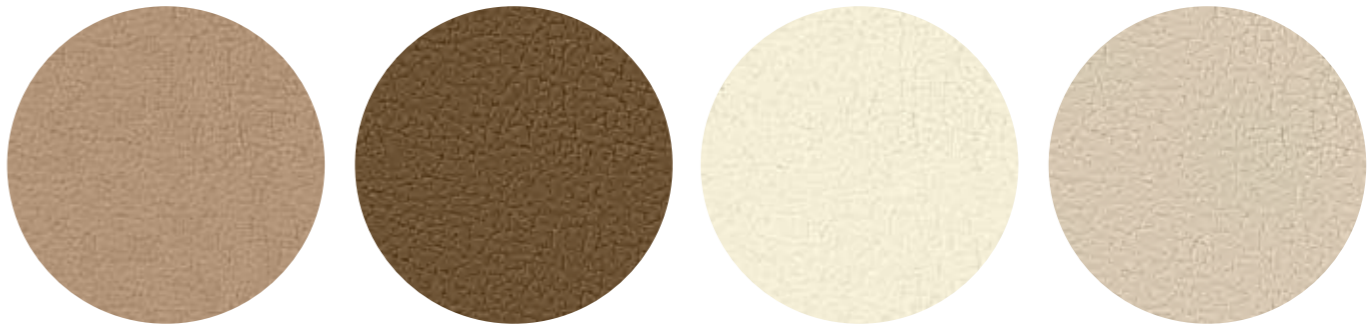

429

446

405

422

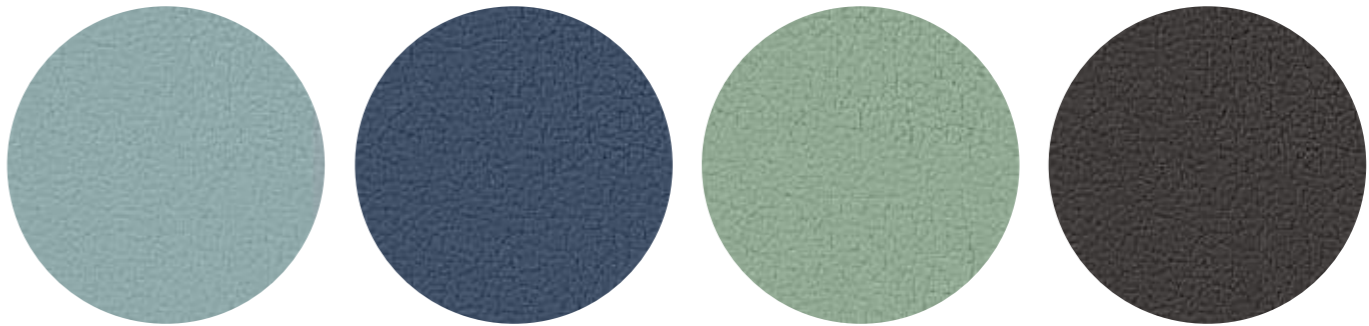

439

440

443

421



---

# tessuti: note tecniche / fabrics: technical notes / tissus: notes techniques / stoffe: technische hinweise / tejidos: notas tecnicas

---

**1** Determinati coloranti di vestiti o di accessori (es. jeans denim) possono migrare verso i colori più chiari. Questo fenomeno è incrementato dall'umidità e dalla temperatura ed è irreversibile. Et al. non si assume nessuna responsabilità per il trasferimento di colorante causato da contaminante esterno e per le possibili macchie permanenti causate da questo fenomeno.

**2** Sono ammesse leggere variazioni di colore tra differenti lotti di produzione dei tessuti.

**3** I colori dei tessuti possono variare rispetto ai riferimenti cromatici forniti nel presente documento a causa delle inevitabili differenze tra i materiali reali e la riproduzione tipografica. Per ulteriori informazioni si prega di contattare l'ufficio commerciale prima dell'ordine.

**1** Certain clothing or accessories dyes (such as those used on denim jeans) may migrate to lighter colors. This phenomenon is increased by humidity and temperature and is irreversible. Et al. will not assume responsibility for dye transfer caused by external contaminants and the possible permanent staining caused by this phenomenon.

**2** Slight color differences may occur between different production batches.

**3** Fabric colors may vary from the color references provided in this document due to the inevitable differences between real materials and typographical reproduction. For more information please contact the sales office.

**1** Les pigments / teintures de certains vêtements et accessoires (telles que celles utilisés pour le jeans) peuvent déteindre sur des surfaces plus claires. Ce phénomène s'accroît avec l'humidité, la température et est irréversible. Et al. n'assume aucune garantie ni responsabilité, ni pour le depot de ces pigments/teintures ni pour l'encrassement permanent causé par ces vêtements / substances.

**2** De légères différences de couleurs peuvent se produire entre différents lots de production.

**3** Les couleurs des tissus peuvent varier comparés à les références de couleur fournies dans ce document en raison des différences inévitables entre les matériaux réels et la reproduction typographique. Pour plus d'informations, avant la commande veuillez contacter le bureau de vente.

**1** Die Farbstoffe bestimmter Textilien und Accessoires (z.B. Jeans) können auf hellere Oberflächen abfärben. Dieser Effekt nimmt mit steigender Feuchtigkeit und Temperatur zu und ist irreversibel. Et al. haften weder für das Abfärben durch externe Stoffe oder verunreinigende Substanzen, noch für eine eventuell dadurch entstehende permanente Verschmutzung / Verfärbung.

**2** Geringfügige Abänderung in Farbe sind, zwischen verschiedenen Produktionschargen von Stoffen, erlaubt.

**3** Die Farben der Stoffe können von Farbe Referenzen hier wegen der unvermeidlichen Unterschiede zwischen realen Materialien und die typografische Reproduktion zur Verfügung gestellten abweichen. Für weitere Fragen, kontaktieren Sie unsere Verkaufsabteilung bitte, bevor der Bestellung.

**1** Ciertas prendas de vestir y tintes de accesorios (como los utilizados en los pantalones vaqueros) pueden migrar a superficies más claras. Este fenómeno se ve incrementado por los efectos de la humedad y la temperatura y es irreversible. Et al. no asumirá ninguna responsabilidad ante reclamos de transferencia de color originados por contaminantes externos ni ante reclamos de manchas permanentes causadas por este fenómeno.

**2** Están admitidas ligeras variaciones de color entre partidas de producción distintas.

**3** Los colores de los tejidos pueden variar con referencia a los presentes en este documento a causa de la diferencia entre el material mismo y su reproducción tipográfica. Para más informaciones favor de contactar la oficina antes de pasar pedidos.

# tessuti: composizione e prove / fabrics: composition and tests / tissus: composition et tests / stoffe: zusammensetzung und test / tejidos: composición y pruebas

<b>cat a</b>	<b>cat b</b>	100% PL Peso / Weight / Poids / Gewicht / Peso: 510 g/m	Hinweise / Notas: Sustainability: Standard 100 by OEKO-TEX; Acoustic test sound absorption ISO 354
<b>fortis</b>	<b>amsterdam</b>	Prove / Tests / Tests / Test / Pruebas: Abrasion resistance EN ISO 12947-1,2: 75.000 rubs; Pilling EN ISO 12945-2:2002: 4; Colour fastness to light ISO 105-B02: 5-7; Colour fastness to rubbing ISO 105-X12:2001: 4-5 dry – 4-5 wet; Fire resistance: BS EN 1021-1 cigarette and match; BS EN 1021-1 cigarette; BS 476 Part 7, class 2; ÖNORM A3800-B2-B3825-Q1 UK; CA TB 117-2013; ASTM E 84 Class I	<b>chili</b> gabriel
Composizione / Composition / Composition / Zusammensetzung / Composición: surface 100% PL; back 95% PL, 5% CO	Composizione / Composition / Composition / Zusammensetzung / Composición: 100% PL	Prove / Tests / Tests / Test / Pruebas: Abrasion resistance EN ISO 12947-1,2: > 100.000 rubs; Pilling EN ISO 12945-2:2002: 5; Colour fastness to light ISO 105-B02: 5; Colour fastness to rubbing ISO 105-X12:2001: 5 dry – 4-5 wet; Tensile strength ISO 13934-1: 733 N (93,4%) warp – 791 N (131%) weft; Tear growth resistance ISO 13937-3: 80,8 N warp – 60,5 N weft; Resistance to seam slippage EN ISO 13936-2: 2,3 mm warp – 2,5 mm weft	Composizione / Composition / Composition / Zusammensetzung / Composición: 100% polyester
Peso / Weight / Poids / Gewicht / Peso: 305 g/m² ± 5%	Peso / Weight / Poids / Gewicht / Peso: 430 g/m² ± 5%	Note / Notes / Remarques / Hinweise / Notas: US ACT: AAATCC 16 Light fastness, AATCC 8 or 116 Wet/dry crocking, ASTM D3511 Pilling, ASTM D4157-07 Wyz abrasion (heavy duty), CA TB 117-2013, ASTM E 84 Class I; Acoustic test air flow resistance EN 29053 & ISO 9053-1; Acoustic test sound absorption ISO 354 & ISO 11654; Sustainability: Standard 100 by OEKO-TEX	Peso / Weight / Poids / Gewicht / Peso: 470 g/ml
Prove / Tests / Tests / Test / Pruebas: Abrasion resistance EN ISO 12947-1,2: > 100.000 rubs; Pilling EN ISO 12945-2:2002: 5; Colour fastness to light ISO 105-B02: 5; Colour fastness to rubbing ISO 105-X12:2001: 4-5 dry – 5 wet; Fire resistance: BS 5852 part 1 Ignition source 0; Tensile strength ISO 13934-1: 1153 N (31,6%) warp – 739 N (26,9%) weft; Tear growth resistance ISO 13937-3: 127,6 N warp – 114,1 N weft; Resistance to seam slippage EN ISO 13936-2: 4,00 mm warp – 4,0 mm weft.	Prove / Tests / Tests / Test / Pruebas: Abrasion resistance EN ISO 12947-1,2: > 100.000 rubs; Pilling EN ISO 12945-2:2002: 5; Colour fastness to light ISO 105-B02: 5; Colour fastness to rubbing ISO 105-X12:2001: 5 dry – 4-5 wet; Tensile strength ISO 13934-1: 733 N (93,4%) warp – 791 N (131%) weft; Tear growth resistance ISO 13937-3: 80,8 N warp – 60,5 N weft; Resistance to seam slippage EN ISO 13936-2: 2,3 mm warp – 2,5 mm weft	Note / Notes / Remarques / Hinweise / Notas: water repellent	Peso / Weight / Poids / Gewicht / Peso: 470 g/ml
Note / Notes / Remarques / Hinweise / Notas: water repellent	<b>inca</b>	Composizione / Composition / Composition / Zusammensetzung / Composición: 88% PVC, 6% PL, 6% CO	<b>mirage</b>
<b>melva</b>	Peso / Weight / Poids / Gewicht / Peso: 650 g/m²	Composizione / Composition / Composition / Zusammensetzung / Composición: 100% PL FR (Trevira Cs)	Note / Notes / Remarques / Hinweise / Notas: US ACT: AAATCC 16 Light fastness, AATCC 8 or 116 Wet/dry crocking, ASTM D3511 Pilling, ASTM D4157-07 Wyz abrasion (heavy duty) 100k, CA TB 117-2013; Sustainability: Standard 100 by OEKO-TEX; Acoustic test air flow resistance EN 29053 & ISO 9053-1
Composizione / Composition / Composition / Zusammensetzung / Composición: 100% PL	Prove / Tests / Tests / Test / Pruebas: Abrasion resistance ISO 5470-2: > 100.000 rubs; Colour fastness to light ISO 105-B02: 7; Colour fastness to rubbing ISO 105-X12:2001: 4 dry – 4 wet; Fire resistance: 11M - UNI 9175; EN 1021 part 1/2; BS 5852 part 1, is 0 and 1; NF D-60 013 (AM. 18); NFPA 260 Class 1; California TB 117:2013; IMO MED - Ftp 307 part 8; ÖNOM B 3825 - schwer brennbar; Tensile strength ISO 1421, 300 N/5 cm warp – 200 N/5 cm weft	Peso / Weight / Poids / Gewicht / Peso: 330 g/m² ± 10%	<b>convert</b>
Peso / Weight / Poids / Gewicht / Peso: 360 g/m² ± 5%	Prove / Tests / Tests / Test / Pruebas: Abrasion resistance EN ISO 12947-1,2: > 100.000 rubs; Pilling EN ISO 12945-2:2002 : 5; Colour fastness to light ISO 105-B02: 4; Colour fastness to rubbing ISO 105-X12:2001: 4-5; Fire resistance: EN 1021-1 cigarette; Tensile strength ISO 13934-1 : 1077 N (36,9%) warp – 1708 N (35,9%) weft; Tear growth resistance ISO 13937-3 : 72,0 N warp – 179,1 N weft; Resistance to seam slippage EN ISO 13936-2: 3,3 mm warp – 3,5 mm weft	Prove / Tests / Tests / Test / Pruebas: Abrasion resistance EN ISO 12947-1,2: 100.000 rubs +/-20%; Pilling EN ISO 12945-2:2002: 4/5 ± ½; Colour fastness to light ISO 105-B02: 6 ± 1; Colour fastness to rubbing ISO 105-X12:2001: 4/5 ± ½; Fire resistance: Classe 11M; EN ISO 6940/6941; BS 5852 Crib 5 using a CM Foam 35 Kg/cu.m.; B1 DIN 4102; EN 1021 part 1-2 using a CM Foam 35 Kg/cu.m.; EN 13773 Class 1; EN 13501-1 esp 1,2; CA TB 117-2013; Fire Protection Classification 5.3; FAR.25853 Classification: yes; M1 + NF D 60-013:2006 AM18; B1-ÖNORM 3800 Part 1 + ÖNORM B3825; Azimut MED annex A.1 item:A.1/3.20 upholstered furniture	Peso / Weight / Poids / Gewicht / Peso: 340 g/m² ± 10%
Prove / Tests / Tests / Test / Pruebas: Abrasion resistance EN ISO 12947-1,2: > 100.000 rubs; Pilling EN ISO 12945-2:2002 : 5; Colour fastness to light ISO 105-B02: 4; Colour fastness to rubbing ISO 105-X12:2001: 4-5; Fire resistance: EN 1021-1 cigarette; Tensile strength ISO 13934-1 : 1077 N (36,9%) warp – 1708 N (35,9%) weft; Tear growth resistance ISO 13937-3 : 72,0 N warp – 179,1 N weft; Resistance to seam slippage EN ISO 13936-2: 3,3 mm warp – 3,5 mm weft	Note / Notes / Remarques / Hinweise / Notas: phtalete free	Composizione / Composition / Composition / Zusammensetzung / Composición: 100% PL (recycled polyester fr)	Peso / Weight / Poids / Gewicht / Peso: 340 g/m² ± 10%
Prove / Tests / Tests / Test / Pruebas: Abrasion resistance EN ISO 12947-1,2: > 100.000 rubs; Pilling EN ISO 12945-2:2002 : 5; Colour fastness to light ISO 105-B02: 4; Colour fastness to rubbing ISO 105-X12:2001: 4-5; Fire resistance: EN 1021-1 cigarette; Tensile strength ISO 13934-1 : 1077 N (36,9%) warp – 1708 N (35,9%) weft; Tear growth resistance ISO 13937-3 : 72,0 N warp – 179,1 N weft; Resistance to seam slippage EN ISO 13936-2: 3,3 mm warp – 3,5 mm weft	<b>medley gabriel</b>	Note / Notes / Remarques / Hinweise / Notas: Note / Notes / Remarques / Hinweise / Notas: Standard 100 by OEKO-TEX; Acoustic test sound absorption ISO 354	Prove / Tests / Tests / Test / Pruebas: Abrasion resistance EN ISO 12947-1,2: 50.000 rubs ± 20%; Pilling EN ISO 12945-2:2002: 4/5 ± ½; Colour fastness to light ISO 105-B02: 6 ± 1; Colour fastness to rubbing ISO 105-X12:2001: 4 ± 1; Fire resistance: Classe 11M; BS 5852 Crib 5 using a CM Foam 35 Kg/cu.m.; B1 DIN 4102;

<b>cat e</b>	<b>cat e</b>	100% PL Peso / Weight / Poids / Gewicht / Peso: 510 g/m	Hinweise / Notas: Sustainability: Standard 100 by OEKO-TEX; Acoustic test sound absorption ISO 354
<b>fortis</b>	<b>amsterdam</b>	Prove / Tests / Tests / Test / Pruebas: Abrasion resistance EN ISO 12947-1,2: 75.000 rubs; Pilling EN ISO 12945-2:2002: 4; Colour fastness to light ISO 105-B02: 5-7; Colour fastness to rubbing ISO 105-X12:2001: 4-5 dry – 4-5 wet; Fire resistance: BS EN 1021-1 cigarette and match; BS EN 1021-1 cigarette; BS 476 Part 7, class 2; ÖNORM A3800-B2-B3825-Q1 UK; CA TB 117-2013; ASTM E 84 Class I	<b>chili</b> gabriel
Composizione / Composition / Composition / Zusammensetzung / Composición: surface 100% PL; back 95% PL, 5% CO	Composizione / Composition / Composition / Zusammensetzung / Composición: 100% PL	Prove / Tests / Tests / Test / Pruebas: Abrasion resistance EN ISO 12947-1,2: > 100.000 rubs; Pilling EN ISO 12945-2:2002: 5; Colour fastness to light ISO 105-B02: 5; Colour fastness to rubbing ISO 105-X12:2001: 5 dry – 4-5 wet; Tensile strength ISO 13934-1: 733 N (93,4%) warp – 791 N (131%) weft; Tear growth resistance ISO 13937-3: 80,8 N warp – 60,5 N weft; Resistance to seam slippage EN ISO 13936-2: 2,3 mm warp – 2,5 mm weft	Composizione / Composition / Composition / Zusammensetzung / Composición: 100% polyester
Peso / Weight / Poids / Gewicht / Peso: 305 g/m² ± 5%	Peso / Weight / Poids / Gewicht / Peso: 430 g/m² ± 5%	Note / Notes / Remarques / Hinweise / Notas: US ACT: AAATCC 16 Light fastness, AATCC 8 or 116 Wet/dry crocking, ASTM D3511 Pilling, ASTM D4157-07 Wyz abrasion (heavy duty), CA TB 117-2013, ASTM E 84 Class I; Acoustic test air flow resistance EN 29053 & ISO 9053-1; Acoustic test sound absorption ISO 354 & ISO 11654; Sustainability: Standard 100 by OEKO-TEX	Peso / Weight / Poids / Gewicht / Peso: 470 g/ml
Prove / Tests / Tests / Test / Pruebas: Abrasion resistance EN ISO 12947-1,2: > 100.000 rubs; Pilling EN ISO 12945-2:2002: 5; Colour fastness to light ISO 105-B02: 5; Colour fastness to rubbing ISO 105-X12:2001: 4-5 dry – 5 wet; Fire resistance: BS 5852 part 1 Ignition source 0; Tensile strength ISO 13934-1: 1153 N (31,6%) warp – 739 N (26,9%) weft; Tear growth resistance ISO 13937-3: 127,6 N warp – 114,1 N weft; Resistance to seam slippage EN ISO 13936-2: 4,00 mm warp – 4,0 mm weft.	Prove / Tests / Tests / Test / Pruebas: Abrasion resistance EN ISO 12947-1,2: > 100.000 rubs; Pilling EN ISO 12945-2:2002: 5; Colour fastness to light ISO 105-B02: 5; Colour fastness to rubbing ISO 105-X12:2001: 5 dry – 4-5 wet; Tensile strength ISO 13934-1: 733 N (93,4%) warp – 791 N (131%) weft; Tear growth resistance ISO 13937-3: 80,8 N warp – 60,5 N weft; Resistance to seam slippage EN ISO 13936-2: 2,3 mm warp – 2,5 mm weft	Note / Notes / Remarques / Hinweise / Notas: water repellent	Peso / Weight / Poids / Gewicht / Peso: 470 g/ml
Note / Notes / Remarques / Hinweise / Notas: water repellent	<b>inca</b>	Composizione / Composition / Composition / Zusammensetzung / Composición: 88% PVC, 6% PL, 6% CO	<b>mirage</b>
<b>melva</b>	Peso / Weight / Poids / Gewicht / Peso: 650 g/m²	Composizione / Composition / Composition / Zusammensetzung / Composición: 100% PL FR (Trevira Cs)	Note / Notes / Remarques / Hinweise / Notas: US ACT: AAATCC 16 Light fastness, AATCC 8 or 116 Wet/dry crocking, ASTM D3511 Pilling, ASTM D4157-07 Wyz abrasion (heavy duty) 100k, CA TB 117-2013; Sustainability: Standard 100 by OEKO-TEX; Acoustic test air flow resistance EN 29053 & ISO 9053-1
Composizione / Composition / Composition / Zusammensetzung / Composición: 100% PL	Prove / Tests / Tests / Test / Pruebas: Abrasion resistance ISO 5470-2: > 100.000 rubs; Colour fastness to light ISO 105-B02: 7; Colour fastness to rubbing ISO 105-X12:2001: 4 dry – 4 wet; Fire resistance: 11M - UNI 9175; EN 1021 part 1/2; BS 5852 part 1, is 0 and 1; NF D-60 013 (AM. 18); NFPA 260 Class 1; California TB 117:2013; IMO MED - Ftp 307 part 8; ÖNOM B 3825 - schwer brennbar; Tensile strength ISO 1421, 300 N/5 cm warp – 200 N/5 cm weft	Peso / Weight / Poids / Gewicht / Peso: 330 g/m² ± 10%	<b>convert</b>
Peso / Weight / Poids / Gewicht / Peso: 360 g/m² ± 5%	Prove / Tests / Tests / Test / Pruebas: Abrasion resistance EN ISO 12947-1,2: > 100.000 rubs; Pilling EN ISO 12945-2:2002 : 5; Colour fastness to light ISO 105-B02: 4; Colour fastness to rubbing ISO 105-X12:2001: 4-5; Fire resistance: EN 1021-1 cigarette; Tensile strength ISO 13934-1 : 1077 N (36,9%) warp – 1708 N (35,9%) weft; Tear growth resistance ISO 13937-3 : 72,0 N warp – 179,1 N weft; Resistance to seam slippage EN ISO 13936-2: 3,3 mm warp – 3,5 mm weft	Prove / Tests / Tests / Test / Pruebas: Abrasion resistance EN ISO 12947-1,2: 100.000 rubs +/-20%; Pilling EN ISO 12945-2:2002: 4/5 ± ½; Colour fastness to light ISO 105-B02: 6 ± 1; Colour fastness to rubbing ISO 105-X12:2001: 4/5 ± ½; Fire resistance: Classe 11M; EN ISO 6940/6941; BS 5852 Crib 5 using a CM Foam 35 Kg/cu.m.; B1 DIN 4102; EN 1021 part 1-2 using a CM Foam 35 Kg/cu.m.; EN 13773 Class 1; EN 13501-1 esp 1,2; CA TB 117-2013; Fire Protection Classification 5.3; FAR.25853 Classification: yes; M1 + NF D 60-013:2006 AM18; B1-ÖNORM 3800 Part 1 + ÖNORM B3825; Azimut MED annex A.1 item:A.1/3.20 upholstered furniture	Peso / Weight / Poids / Gewicht / Peso: 340 g/m² ± 10%
Prove / Tests / Tests / Test / Pruebas: Abrasion resistance EN ISO 12947-1,2: > 100.000 rubs; Pilling EN ISO 12945-2:2002 : 5; Colour fastness to light ISO 105-B02: 4; Colour fastness to rubbing ISO 105-X12:2001: 4-5; Fire resistance: EN 1021-1 cigarette; Tensile strength ISO 13934-1 : 1077 N (36,9%) warp – 1708 N (35,9%) weft; Tear growth resistance ISO 13937-3 : 72,0 N warp – 179,1 N weft; Resistance to seam slippage EN ISO 13936-2: 3,3 mm warp – 3,5 mm weft	Note / Notes / Remarques / Hinweise / Notas: phtalete free	Composizione / Composition / Composition / Zusammensetzung / Composición: 100% PL (recycled polyester fr)	Peso / Weight / Poids / Gewicht / Peso: 340 g/m² ± 10%
Prove / Tests / Tests / Test / Pruebas: Abrasion resistance EN ISO 12947-1,2: > 100.000 rubs; Pilling EN ISO 12945-2:2002 : 5; Colour fastness to light ISO 105-B02: 4; Colour fastness to rubbing ISO 105-X12:2001: 4-5; Fire resistance: EN 1021-1 cigarette; Tensile strength ISO 13934-1 : 1077 N (36,9%) warp – 1708 N (35,9%) weft; Tear growth resistance ISO 13937-3 : 72,0 N warp – 179,1 N weft; Resistance to seam slippage EN ISO 13936-2: 3,3 mm warp – 3,5 mm weft	<b>medley gabriel</b>	Note / Notes / Remarques / Hinweise / Notas: Note / Notes / Remarques / Hinweise / Notas: Standard 100 by OEKO-TEX; Acoustic test sound absorption ISO 354	Prove / Tests / Tests / Test / Pruebas: Abrasion resistance EN ISO 12947-1,2: 50.000 rubs ± 20%; Pilling EN ISO 12945-2:2002: 4/5 ± ½; Colour fastness to light ISO 105-B02: 6 ± 1; Colour fastness to rubbing ISO 105-X12:2001: 4 ± 1; Fire resistance: Classe 11M; BS 5852 Crib 5 using a CM Foam 35 Kg/cu.m.; B1 DIN 4102;

EN 1021 part 1-2 using a CM Foam 35 Kg/cu.m.; CA TB 117-2013; M1 + NF D 60-013:2006 AM18; Azimut MED annex A.1 item:A.1/3.20 upholstered furniture	Prove / Tests / Tests / Test / Pruebas: Abrasion resistance EN ISO 12947-1,2:70.000 rubs; Pilling EN ISO 12945-2:2002: 4-5; Colour fastness to light ISO 105-B02: 5-8; Colour fastness to rubbing ISO 105-X12:2001: 4-5 dry – 4-5 wet; Fire resistance: BS EN 1021-1 cigarette; BS EN 1021-2 match; CA TB 117-2013; Resistance to seam slippage EN ISO 13936-2: 3 mm warp - 3 mm weft	Prove / Tests / Tests / Test / Pruebas: Abrasion resistance EN ISO 12947-1,2: 100.000 rubs; Pilling EN ISO 12945-2:2002: 4; Colour fastness to light ISO 105-B02: 5-7; Colour fastness to rubbing ISO 105-X12:2001: 4-5 dry – 4-5 wet; Fire resistance: BS EN 1021-2 match; BS EN 1021-1 cigarette; BS 5852 part 1 0,1 cigarette & match; BS 476 Part 7, class 1; Class Uno UNI 9175 Class 1 IM; CA TB 117-2013; Resistance to seam slippage EN ISO 13936-2: 1 mm warp - 2 mm weft	117-2013; M1 NFP902-503-504-505; B1 DIN 4102-1; IMO 8 Upholstery
Note / Notes / Remarques / Hinweise / Notas: Sustainability: OEKO TEX N.072150.O; Acoustic test sound absorption ISO 354	<b>fenice</b>	Note / Notes / Remarques / Hinweise / Notas: US ACT: AAATCC 16 Light fastness, AATCC 8 or 116 Wet/dry crocking, ASTM D3511 Pilling, ASTM D4157-07 Wyz abrasion (heavy duty) 100k, CA TB 117-2013; Sustainability: STANDARD 100 by OEKO-TEX®; EU Ecolabel	Note / Notes / Remarques / Hinweise / Notas: Sustainability: Greenguard Gold, STANDARD 100 by OEKO-TEX®
Composizione / Composition / Composition / Zusammensetzung / Composición: 75% WO, 25% PA	Composizione / Composition / Composition / Zusammensetzung / Composición: 100% polyester	Note / Notes / Remarques / Hinweise / Notas: US ACT: AAATCC 16 Light fastness, AATCC 8 or 116 Wet/dry crocking, ASTM D3511 Pilling, ASTM D4966 Martindale (heavy duty), CA TB 117-2013; Sustainability: STANDARD 100 by OEKO-TEX®; EU Ecolabel	<b>remix 3</b> kvadrat
Peso / Weight / Poids / Gewicht / Peso: 335 g/m² ± 7%	Peso / Weight / Poids / Gewicht / Peso: 470 g/ml	Peso / Weight / Poids / Gewicht / Peso: 650 g/m²	Composizione / Composition / Composition / Zusammensetzung / Composición: 90% WO (new wool) + 10% NY
Prove / Tests / Tests / Test / Pruebas: Abrasion resistance EN ISO 12947-1,2: 100.000 rubs ± 20%; Pilling EN ISO 12945-2:2002: 4 ± 1; Colour fastness to rubbing ISO 105-X12:2001: 4/5 ± ½; Fire resistance: Classe 11M using a standard FR polyurethane foam 25 kg/cu.m.; EN 1021 part 1-2 using a standard foam 20/22 kg/cu.m.; CA TB 117-2013	<b>chili</b> gabriel	Prove / Tests / Tests / Test / Pruebas: Abrasion resistance EN ISO 12947-1,2: 300.000 rubs; Fire resistance: UNI 9175 Classe 11M; EN 1021 Part 1 & 2; CAL TB 117-2013, Section E; UNE 23.727-90 1R/M.2; NF P 92-503/M2; DIN 4102 B2; ÖNORM B 3825, Gruppe 1 - Schwerbrennbares Verhalten; ÖNORM A 3800 Teil 1, Qualmbildungsklasse Q1 - schwachqualmend; IMO Res. MSC.307 (88) (FTP 2010 Code) Annex 1 Part 8; FMVSS 302; FAR 25/853; MED (in its current valid version 2021); ECE R118.02 (replaces Directive 95/28/CE) Annexes 6, 7 & 8; EN 71-2:2006+A1:2007 - Safety of Toys - Parte 2: Flammability	Peso / Weight / Poids / Gewicht / Peso: 420 g/m
Note / Notes / Remarques / Hinweise / Notas: Acoustic test sound absorption ISO 354	<b>in&amp;out</b>	Peso / Weight / Poids / Gewicht / Peso: 650 g/m²	Prove / Tests / Tests / Test / Pruebas: Abrasion resistance EN ISO 12947-1,2: 100.000 rubs; Pilling EN ISO 12945-2:2002: 4; Colour fastness to light ISO 105-B02: 6-7; Colour fastness to rubbing ISO 105-X12:2001: 4-5 dry – 4-5 wet; Fire resistance: UNI 9175 11M; EN 1021-1/2; BS 5852 ignition source 3; BS 5852 part 1; CA TB 117-2013; IMO FTP Code 2010: part 8; NF D60 013; NFPA 260; AS/NZS 1530.3; AS/NZS 3837 class 2; ÖNORM B1/Q1; Resistance to seam slippage EN ISO 13936-2: 5 mm warp - 3 mm weft
Prove / Tests / Tests / Test / Pruebas: Abrasion resistance EN ISO 12947-1,2: > 100.000 rubs; Pilling EN ISO 12945-2:2002: 5; Colour fastness to light ISO 105-B02: 5; Colour fastness to rubbing ISO 105-X12:2001: 5 dry – 4-5 wet; Tensile strength ISO 13934-1: 733 N (93,4%) warp – 791 N (131%) weft; Tear growth resistance ISO 13937-3: 80,8 N warp – 60,5 N weft; Resistance to seam slippage EN ISO 13936-2: 2,3 mm warp – 2,5 mm weft	Composizione / Composition / Composition / Zusammensetzung / Composición: Vinyl / Urethane topcoat	Prove / Tests / Tests / Test / Pruebas: Abrasion resistance EN ISO 12947-1,2: 300.000 rubs; Fire resistance: UNI 9175 Classe 11M; EN 1021 Part 1 & 2; CAL TB 117-2013, Section E; UNE 23.727-90 1R/M.2; NF P 92-503/M2; DIN 4102 B2; ÖNORM B 3825, Gruppe 1 - Schwerbrennbares Verhalten; ÖNORM A 3800 Teil 1, Qualmbildungsklasse Q1 - schwachqualmend; IMO Res. MSC.307 (88) (FTP 2010 Code) Annex 1 Part 8; FMVSS 302; FAR 25/853; MED (in its current valid version 2021); ECE R118.02 (replaces Directive 95/28/CE) Annexes 6, 7 & 8; EN 71-2:2006+A1:2007 - Safety of Toys - Parte 2: Flammability	Note / Notes / Remarques / Hinweise / Notas: Acoustic test air flow resistance EN 29053; Acoustic test sound absorption ISO 354; Complies with Möbelfakta; Sustainability: EU Ecolabel, Greenguard Gold, HPD, EPD
Note / Notes / Remarques / Hinweise / Notas: water repellent	Peso / Weight / Poids / Gewicht / Peso: 470 g/ml	Prove / Tests / Tests / Test / Pruebas: Abrasion resistance EN ISO 12947-1,2: 300.000 rubs; Fire resistance: UNI 9175 Classe 11M; EN 1021 Part 1 & 2; CAL TB 117-2013, Section E; UNE 23.727-90 1R/M.2; NF P 92-503/M2; DIN 4102 B2; ÖNORM B 3825, Gruppe 1 - Schwerbrennbares Verhalten; ÖNORM A 3800 Teil 1, Qualmbildungsklasse Q1 - schwachqualmend; IMO Res. MSC.307 (88) (FTP 2010 Code) Annex 1 Part 8; FMVSS 302; FAR 25/853; MED (in its current valid version 2021); ECE R118.02 (replaces Directive 95/28/CE) Annexes 6, 7 & 8; EN 71-2:2006+A1:2007 - Safety of Toys - Parte 2: Flammability	<b>ocean</b> mastrotto
<b>melva</b>	Peso / Weight / Poids / Gewicht / Peso: 650 g/m²	Prove / Tests / Tests / Test / Pruebas: Abrasion resistance EN ISO 12947-1,2: 300.000 rubs; Fire resistance: UNI 9175 Classe 11M; EN 1021 Part 1 & 2; CAL TB 117-2013, Section E; UNE 23.727-90 1R/M.2; NF P 92-503/M2; DIN 4102 B2; ÖNORM B 3825, Gruppe 1 - Schwerbrennbares Verhalten; ÖNORM A 3800 Teil 1, Qualmbildungsklasse Q1 - schwachqualmend; IMO Res. MSC.307 (88) (FTP 2010 Code) Annex 1 Part 8; FMVSS 302; FAR 25/853; MED (in its current valid version 2021); ECE R118.02 (replaces Directive 95/28/CE) Annexes 6, 7 & 8; EN 71-2:2006+A1:2007 - Safety of Toys - Parte 2: Flammability	Composizione / Composition / Composition / Zusammensetzung / Composición: leather
Composizione / Composition / Composition / Zusammensetzung / Composición: 100% PL	Prove / Tests / Tests / Test / Pruebas: Abrasion resistance ISO 5470-2: > 100.000 rubs; Colour fastness to light ISO 105-B02: 7; Colour fastness to rubbing ISO 105-X12:2001: 4 dry – 4 wet; Fire resistance: 11M - UNI 9175; EN 1021 part 1/2; BS 5852 part 1, is 0 and 1; NF D-60 013 (AM. 18); NFPA 260 Class 1; California TB 117:2013; IMO MED - Ftp 307 part 8; ÖNOM B 3825 - schwer brennbar; Tensile strength ISO 1421, 300 N/5 cm warp – 200 N/5 cm weft	Note / Notes / Remarques / Hinweise / Notas: Antibacterial Protection; Antifungal Protection; Antimycotic Protection; PERMABLOK3®; Anti-stain Finish; Cold Crack -23°C; Mildew resistant backing and face; UV-Resistance XENOTEST DIN 54004/ NTC 1479; EN 71-3 Safety of Toys (Migration of certain elements); Sulfide Stain Resistant; Anti-static Finish	Composizione / Composition / Composition / Zusammensetzung / Composición: leather
Peso / Weight / Poids / Gewicht / Peso: 360 g/m² ± 5%	Prove / Tests / Tests / Test / Pruebas: Abrasion resistance EN ISO 12947-1,2: > 100.000 rubs; Pilling EN ISO 12945-2:2002 : 5; Colour fastness to light ISO 105-B02: 4; Colour fastness to rubbing ISO 105-X12:2001: 4-5; Fire resistance: EN 1021-1 cigarette; Tensile strength ISO 13934-1 : 1077 N (36,9%) warp – 1708 N (35,9%) weft; Tear growth resistance ISO 13937-3 : 72,0 N warp – 179,1 N weft; Resistance to seam slippage EN ISO 13936-2: 3,3 mm warp – 3,5 mm weft	Note / Notes / Remarques / Hinweise / Notas: indoor&outdoor (no water repellent); UV resistant; Breathable; Antibacterial; Mold resistant; no-rot; Recyclable; STANDARD 100 by OEKO-TEX®	Composizione / Composition / Composition / Zusammensetzung / Composición: leather
Prove / Tests / Tests / Test / Pruebas: Abrasion resistance EN ISO 12947-1,2: > 100.000 rubs; Pilling EN ISO 12945-2:2002 : 5; Colour fastness to light ISO 105-B02: 4; Colour fastness to rubbing ISO 105-X12:2001: 4-5; Fire resistance: EN 1021-1 cigarette; Tensile strength ISO 13934-1 : 1077 N (36,9%) warp – 1708 N (35,9%) weft; Tear growth resistance ISO 13937-3 : 72,0 N warp – 179,1 N weft; Resistance to seam slippage EN ISO 13936-2: 3,3 mm warp – 3,5 mm weft	Note / Notes / Remarques / Hinweise / Notas: phtalete free	Prove / Tests / Tests / Test / Pruebas: Abrasion resistance EN ISO 12947-1,2: 25.000 rubs; Pilling EN ISO 12945-2:2002: 4-5; Colour fastness to light ISO 105-B02: 7; Colour fastness to rubbing ISO 105-X12:2001: 4-5 dry – 4 wet; Resistance to seam slippage EN ISO 13936-2: 4 mm warp – 4 mm weft	Composizione / Composition / Composition / Zusammensetzung / Composición: leather
Prove / Tests / Tests / Test / Pruebas: Abrasion resistance EN ISO 12947-1,2: > 100.000 rubs; Pilling EN ISO 12945-2:2002 : 5; Colour fastness to light ISO 105-B02: 4; Colour fastness to rubbing ISO 105-X12:2001: 4-5; Fire resistance: EN 1021-1 cigarette; Tensile strength ISO 13934-1 : 1077 N (36,9%) warp – 1708 N (35,9%) weft; Tear growth resistance ISO 13937-3 : 72,0 N warp – 179,1 N weft; Resistance to seam slippage EN ISO 13936-2: 3,3 mm warp – 3,5 mm weft	<b>inca</b>	Note / Notes / Remarques / Hinweise / Notas: indoor&outdoor (no water repellent); UV resistant; Breathable; Antibacterial; Mold resistant; no-rot; Recyclable; STANDARD 100 by OEKO-TEX®	Composizione / Composition / Composition / Zusammensetzung / Composición: leather
Peso / Weight / Poids / Gewicht / Peso: 360 g/m² ± 5%	Peso / Weight / Poids / Gewicht / Peso: 650 g/m²	Note / Notes / Remarques / Hinweise / Notas: indoor&outdoor (no water repellent); UV resistant; Breathable; Antibacterial; Mold resistant; no-rot; Recyclable; STANDARD 100 by OEKO-TEX®	Composizione / Composition / Composition / Zusammensetzung / Composición: leather
Prove / Tests / Tests / Test / Pruebas: Abrasion resistance EN ISO 12947-1,2: > 100.000 rubs; Pilling EN ISO 12945-2:2002 : 5; Colour fastness to light ISO 105-B02: 4; Colour fastness to rubbing ISO 105-X12:2001: 4-5; Fire resistance: EN 1021-1 cigarette; Tensile strength ISO 13934-1 : 1077 N (36,9%) warp – 1708 N (35,9%) weft; Tear growth resistance ISO 13937-3 : 72,0 N warp – 179,1 N weft; Resistance to seam slippage EN ISO 13936-2: 3,3 mm warp – 3,5 mm weft	Prove / Tests / Tests / Test / Pruebas: Abrasion resistance EN ISO 12947-1,2: > 100.000 rubs; Pilling EN ISO 12945-2:2002 : 5; Colour fastness to light ISO 105-B02: 7; Colour fastness to rubbing ISO 105-X12:2001: 4 dry – 4 wet; Fire resistance: 11M - UNI 9175; EN 1021 part 1/2; BS 5852 part 1, is 0 and 1; NF D-60 013 (AM. 18); NFPA 260 Class 1; California TB 117:2013; IMO MED - Ftp 307 part 8; ÖNOM B 3825 - schwer brennbar; Tensile strength ISO 1421, 300 N/5 cm warp – 200 N/5 cm weft	Note / Notes / Remarques / Hinweise / Notas: indoor&outdoor (no water repellent); UV resistant; Breathable; Antibacterial; Mold resistant; no-rot; Recyclable; STANDARD 100 by OEKO-TEX®	Composizione / Composition / Composition / Zusammensetzung / Composición: leather
Prove / Tests / Tests / Test / Pruebas: Abrasion resistance EN ISO 12947-1,2: > 100.000 rubs; Pilling EN ISO 12945-2:2002 : 5; Colour fastness to light ISO 105-B02: 4; Colour fastness to rubbing ISO 105-X12:2001: 4-5; Fire resistance: EN			

finiture telai /  
frames finishes /  
finitions piètements /  
gestellfertigungen /  
acabados estructuras

acciaio / steel / acier /  
stahl / acero

AC

acciaio / steel / acier / stahl / acero



eccetto CR Cromato / except CR Chrome / sauf CR Chromé / außer CR Verchromt / excepto CR Cromado

\* disponibile solo per alcuni prodotti - vedi listino prezzi / Available only for selected products - see price list / Disponible seulement pour certains produits, voir la liste de prix / Nur für einige Produkte verfügbar - Siehe Preisliste / Disponible solamente para algunos productos - ver lista de precios.

Salinero solo NCS S9000-N VR Nero intenso opaco / only VR Matt Jet Black / seulement VR Noir foncé opaque / nur VR Matt Tiefschwarz / solamente VR Negro intenso mate



NCS S0502-B  
VR Bianco traffico /  
VR Traffic white /  
VR Blanc signalisation /  
VR Verkehrsweiß /  
VR Blanco tráfico



NCS S0500-N  
VR Bianco puro /  
VR Pure white /  
VR Blanc pur /  
VR Reinweiß /  
VR Blanco puro



NCS S4000-N  
VR Alluminio brillante /  
VR White aluminium /  
VR Aluminium blanc /  
VR Weißaluminium /  
VR Aluminio blanco



VR Peltro /  
VR Pewter /  
VR Etain /  
VR Zinn /  
VR Peltre



NCS S7502-B  
VR Grigio antracite /  
VR Anthracite grey /  
VR Gris anthracite /  
VR Anthrazitgrau /  
VR Gris antracita



NCS S9000-N  
VR Nero intenso /  
VR Jet black /  
VR Noir foncé /  
VR Tiefschwarz /  
VR Negro intenso



NCS S9000-N  
VR Nero intenso opaco /  
VR Matt Jet Black /  
VR Noir foncé opaque /  
VR Matt Tiefschwarz /  
VR Negro intenso mate



VR Bronzo metallico bucciato /  
VR Rough metallic bronze /  
VR Bronze métallique texturé /  
VR Rau Metallbronze /  
VR Bronce metálico áspero

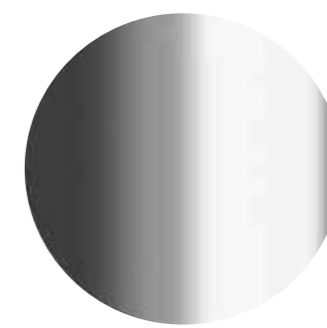

CR Cromato /  
CR Chrome /  
CR Chromé /  
CR Verchromt /  
CR Cromado



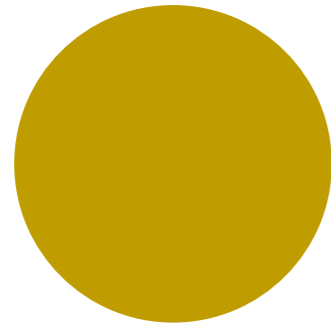

NCS S3060-Y  
VR Giallo curry / VR Curry /  
VR Jaune curry / VR Currygelb /  
VR Amarillo curry

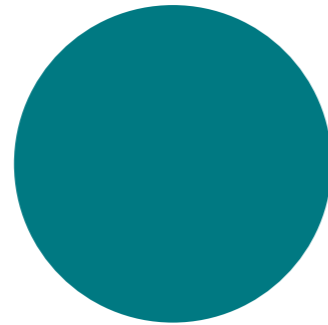

NCS S4050-B40G  
VR Blu acqua / VR Water blue /  
VR Bleu d'eau / VR Wasserblau /  
VR Azul agua

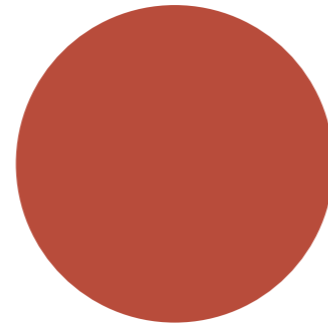

NCS S3060-Y80R  
VR Rosso corallo /  
VR Coral red / VR Rouge corail /  
VR Korallenrot / VR Rojo coral

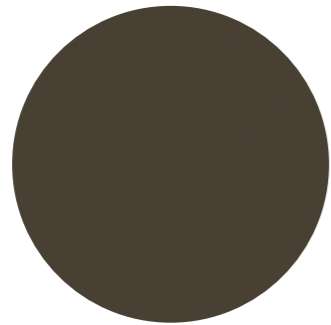

NCS S8005-Y20R  
VR Marrone / VR Brown /  
VR Marron / VR Braun /  
VR Marrón

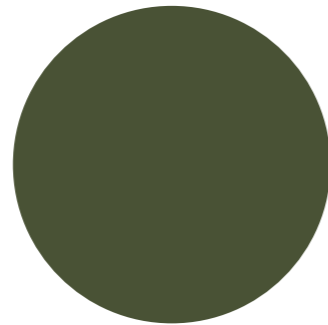

NCS S7020-G50Y  
VR Verde oliva /  
VR Olive green /  
VR Vert olive /  
VR Olivgrün /  
VR Verde oliva

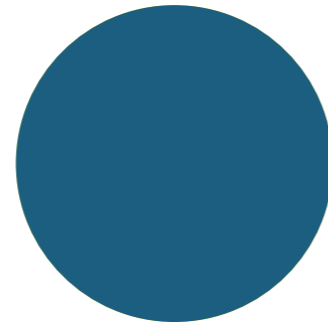

NCS S6030-B  
VR Blu capri / VR Capri blue /  
VR Bleu capri / VR Blau Capri /  
VR Azul capri

AX

acciaio inox AISI 304 18/10 / AISI 304 18/10 stainless steel /  
acier inoxydable AISI 304 18/10 / AISI 304 18/10 Edelstahl /  
acero inoxidable AISI 304 18/10

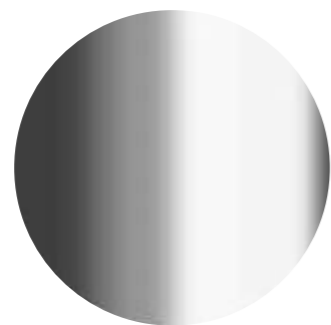

LUC Lucido /  
LUC Gloss /  
LUC Brillant /  
LUC Poliert /  
LUC Pulido



SAT Satinato /  
SAT Satin /  
SAT Satiné /  
SAT Matt /  
SAT Satinado

alluminio / aluminium / aluminium /  
aluminium / aluminio

AL

alluminio / aluminium / aluminium / aluminium / aluminio

AL AND

alluminio anodizzato / anodized aluminium / aluminium anodisé /  
eloxiertes aluminium / aluminio anodizado



solo / only /  
seulement / nur /  
solamente Marè



Nero satinato /  
Matt Black /  
Noir satiné /  
Matt Schwarz /  
Negro satinado

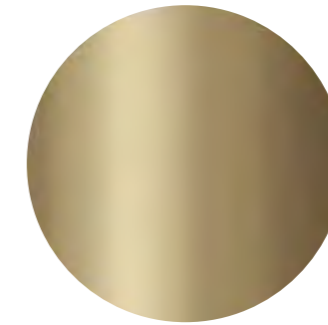

Bronzo satinato /  
Matt bronze /  
Bronze satiné /  
Matt Bronze /  
Bronce satinado

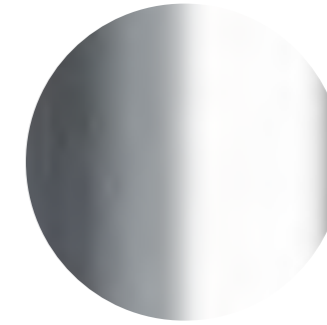

Lucido / Glossy /  
Brillant / Poliert /  
Pulido

AL PSH

alluminio lucidato / polished aluminium /  
aluminium brillant / poliertes aluminium /  
aluminio pulido



Alluminio lucidato /  
Polished aluminium /  
Aluminium brillant /  
Poliertes Aluminium /  
Aluminio pulido

# AL VR

alluminio verniciato / painted aluminium /  
aluminium verni / lackiert aluminium / aluminio barnizado



Agatha 046-DP, 046-DR; Classy 1086, 1087, 1088, 1089; Ibis 002-DP, 002-DR; Kicca 021-DP, 021-DR; Marka 569-DP, 569-DR; Myra 677, 678, 683; Snap 1108, 1109, 1110, 1111; Uni 558-DP, 558-DR, 558M-DP, 558M-DR; Uni-Ka 597-DP, 597-DR, 597M-DP, 597M-DR; solo / only / seulement / nur / solamente NC S9000-N VR Nero intenso opaco / VR Matt Jet Black / VR Noir foncé opaque / VR Matt Tiefschwarz / VR Negro intenso mate



NCS S0502-B  
VR Bianco traffico /  
VR Traffic white /  
VR Blanc signalisation /  
VR Verkehrsweiß /  
VR Blanco tráfico



NCS S0500-N  
VR Bianco puro /  
VR Pure white /  
VR Blanc pur /  
VR Reinweiß /  
VR Blanco puro



NCS S4000-N  
VR Alluminio brillante /  
VR White aluminium /  
VR Aluminium blanc /  
VR Weißaluminium /  
VR Aluminio blanco



VR Peltro /  
VR Pewter /  
VR Etain /  
VR Zinn /  
VR Peltre



NCS S7502-B  
VR Grigio antracite /  
VR Anthracite grey /  
VR Gris anthracite /  
VR Anthrazitgrau /  
VR Gris antracita



NCS S9000-N  
VR Nero intenso /  
VR Jet black /  
VR Noir foncé /  
VR Tiefschwarz /  
VR Negro intenso



NCS S9000-N  
VR Nero intenso opaco /  
VR Matt Jet Black /  
VR Noir foncé opaque /  
VR Matt Tiefschwarz /  
VR Negro intenso mate



VR Bronzo metallico bucciato /  
VR Rough metallic bronze /  
VR Bronze métallique texturé /  
VR Rau Metallbronze /  
VR Bronce metálico áspero

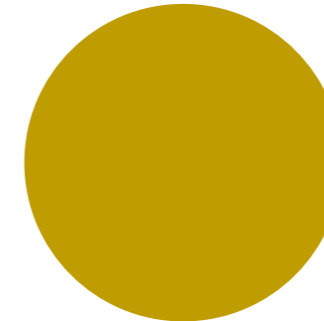

NCS S3060-Y  
VR Giallo curry / VR Curry /  
VR Jaune curry / VR Currygelb /  
VR Amarillo curry

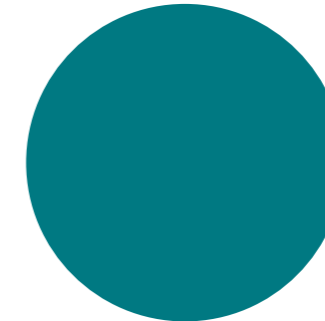

NCS S4050-B40G  
VR Blu acqua / VR Water blue /  
VR Bleu d'eau / VR Wasserblau /  
VR Azul agua

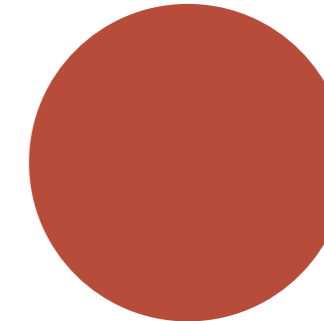

NCS S3060-Y80R  
VR Rosso corallo /  
VR Coral red / VR Rouge corail /  
VR Korallenrot / VR Rojo coral

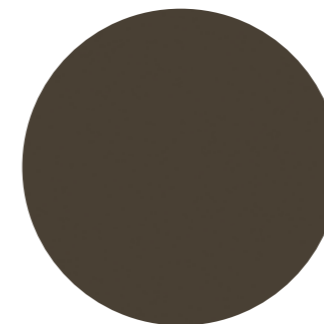

NCS S8005-Y20R  
VR Marrone / VR Brown /  
VR Marron / VR Braun /  
VR Marrón

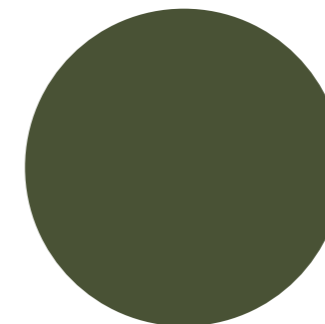

NCS S7020-G50Y  
VR Verde oliva /  
VR Olive green /  
VR Vert olive /  
VR Olivgrün /  
VR Verde oliva

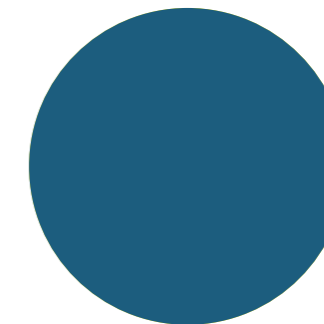

NCS S6030-B  
VR Blu capri / VR Capri blue /  
VR Bleu capri / VR Blau Capri /  
VR Azul capri

legno / wood / bois /  
holz / maderera

**LE**

**faggio**  
beech /  
hêtre /  
Buche /  
haya



Tinto miele /  
Honey stained /  
Teinté miel /  
Honig gefärbt /  
Tenido miel



Tinto castano /  
Chesnut stained /  
Teinté châtaigne /  
Kastanie gefärbt /  
Tenido castaño



Tinto grigio /  
Grey stained /  
Teinté gris /  
Grau gefärbt /  
Tenido gris

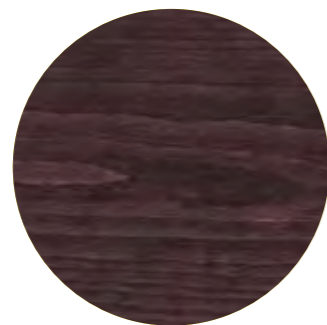

Tinto bruno /  
Dark brown stained /  
Teinté brun /  
Dunkel braun gefärbt /  
Tenido pardo



Tinto nero /  
Black stained /  
Teinté noir /  
Schwarz gefärbt /  
Tenido negro

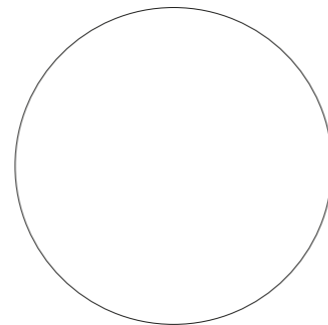

Tinto campione /  
Stained according to sample /  
Teinté selon échantillon /  
Kundenmuster gefärbt /  
Tenido según muestra

Ordine minimo 10 pz /  
Minimum order 10 pcs /  
Minimum de commande 10 pièces /  
Mindestbestell 10 Stück /  
Mínimo de compra 10 piezas

**frassino**  
ash /  
frêne /  
Esche /  
fresno



Tinto miele /  
Honey stained /  
Teinté miel /  
Honig gefärbt /  
Tenido miel



Tinto castano /  
Chesnut stained /  
Teinté châtaigne /  
Kastanie gefärbt /  
Tenido castaño



Tinto grigio /  
Grey stained /  
Teinté gris /  
Grau gefärbt /  
Tenido gris



Tinto bruno /  
Dark brown stained /  
Teinté brun /  
Dunkel braun gefärbt /  
Tenido pardo



Tinto nero /  
Black stained /  
Teinté noir /  
Schwarz gefärbt /  
Tenido negro

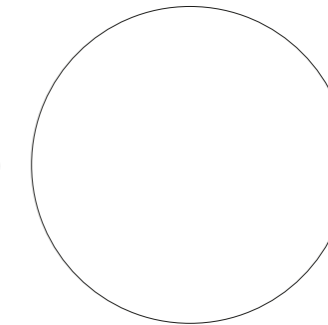

Tinto campione /  
Stained according to sample /  
Teinté selon échantillon /  
Kundenmuster gefärbt /  
Tenido según muestra

Ordine minimo 10 pz /  
Minimum order 10 pcs /  
Minimum de commande 10 pièces /  
Mindestbestell 10 Stück /  
Mínimo de compra 10 piezas

laminato / laminate / stratifié /  
laminat / laminado

**LAM**

Solo come finitura per fianco, zoccolo e retro panca Space (vedi pag 408/409).  
Solo come finitura per Deck (vedi pag 408/409) / Finishing available for side,  
front and back of Space bench only (see p. 408/409). Finishing available for Deck  
only (see p. 408/409) / Finition disponible uniquement pour coté, plinthe et dossier  
de banquette Space (voir p. 408/409). Finition disponible uniquement pour Deck  
(voir p. 413) / Fertigung nur für Seite, Sockel und Hinten von Space Bänke  
(siehe Seite 408/409). Fertigung nur für Deck (siehe S. 408/409) / Solamente como  
acabado por lado, base frente y trasera de las banquetas Space (veer pág. 408/409).  
Solamente como acabado por Deck (veer pág. 408/409)



finiture piani tavoli /  
table tops finishes /  
finitions plateaux de table /  
tischplattenfertigungen /  
acabados por sobres  
de mesas

---

stratificato HPL / HPL solid  
laminate / stratifié HPL / HPL  
compact platte / estratificado HPL

---

STR



Bianco / White / Blanc / Weiss / Blanco, Grigio argento / Silver grey / Gris argent /  
Silbergrau / Grisplata, Moka / Mocha / Moka / Mokka / Moka, Antracite / Anthracite /  
Anthracite / Anthrazit / Antracita

---

**full color**



Bianco / White /  
Blanc / Weiss /  
Blanco

**compact**

cat. A



Bianco / White / Blanc /  
Weiss / Blanco

cat. B

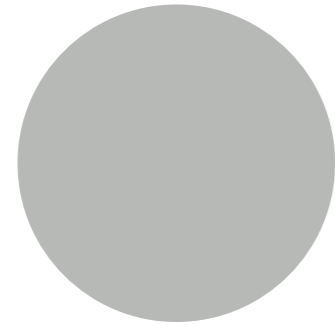

Grigio argento /  
Silver grey / Gris argent /  
Silbergrau / Grisplata

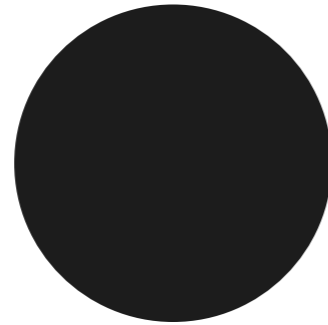

Nero / Black / Noir /  
Schwarz / Negro



Moka / Mocha /  
Moka / Mokka /  
Moka

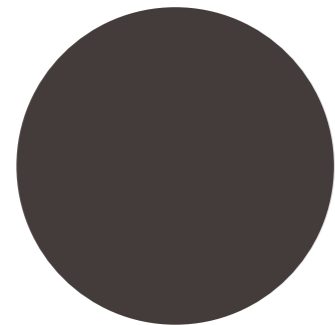

Antracite / Anthracite /  
Anthracite / Anthrazit /  
Antracita

cat. C



Abet 313  
Wengè congo /  
Congo wengè /  
Wenge congo /  
Wengè congo /  
Wengè congo



Abet 546  
Tivoli / Tivoli / Tivoli /  
Tivoli / Tivoli



Abet 1394  
Olmo perlato / Pearl elm /  
Orme perlé / Perlulme /  
Olmo perlado

cat. D



Arpa 4420  
Rovere allier /  
Allier oak / Chêne allier /  
Eiche Allier / Roble allier



Abet 1459  
Statuario / Statuario /  
Statuaire / Bildhauerei /  
Statuario

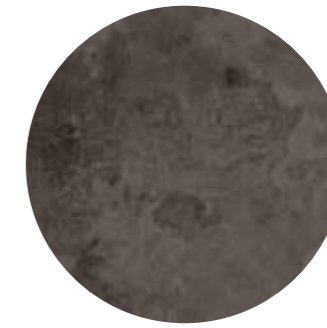

Abet 545  
Vulcano / Vulcano /  
Volcan / Vulkan /  
Volcán



Abet 557  
Boiaccia grigio /  
Cement grey / Gris ciment /  
Zementgrau / Gris lechada

cat. H

Antimpronta /  
Anti-fingerprints /  
Anti-empreinte /  
Anti Fingerabdrücke /  
Antihuella

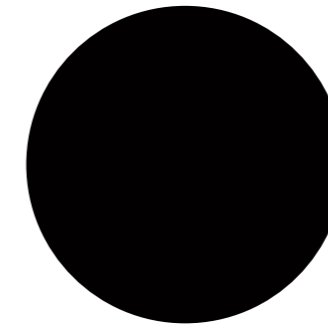

Fenix NTM 0720  
Nero ingo / Ingo black / Noir  
ingo / Schwarz ingo / Negro ingo

dalton,  
salinero

piani / table tops /  
plateaux /  
tischplatten /  
sobres de mesas



Full color  
Bianco / White /  
Blanc / Weiss /  
Blanco

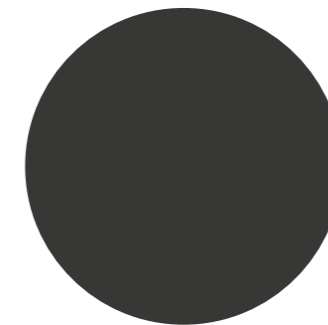

Compact  
Grafite / Graphite /  
Graphite / Graphite /  
Grafito

Antimpronta / Anti-fingerprints /  
Anti-empreinte / Anti  
Fingerabdrücke / Antihuella

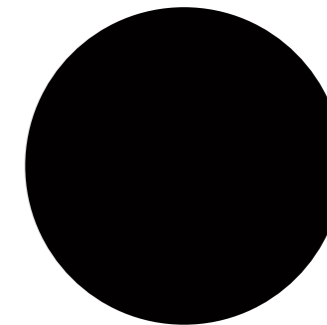

Compact  
Fenix NTM 0720  
Nero ingo / Ingo black / Noir ingo /  
Schwarz ingo / Negro ingo

Antimpronta / Anti-fingerprints /  
Anti-empreinte / Anti  
Fingerabdrücke / Antihuella

laminato / laminate / stratifié /  
laminat / laminado

LAM

cat. J



Arpa 20  
Bianco / White /  
Blanc / Weiß /  
Blanco  
*fin.erre*

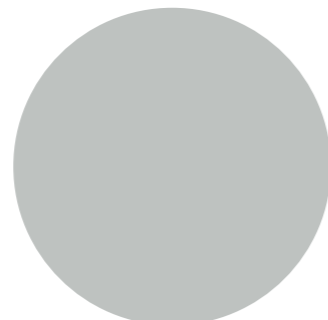

Arpa 211  
Grigio argento /  
Silver grey / Gris argent /  
Silbergrau / Gris plata  
*fin.erre*

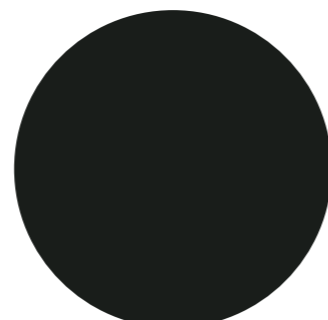

Arpa 509  
Nero / Black /  
Noir / Schwarz /  
Negro  
*fin.erre*



Abet 313  
Wengè congo /  
Congo wengè /  
Wenge congo /  
Wengé congo /  
Wengé congo  
*fin.nutshell*

cat. K

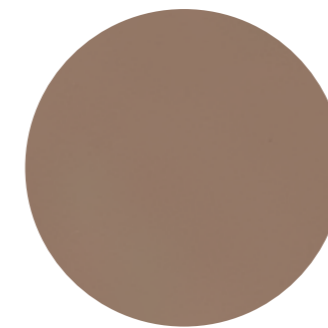

Abet 893  
Terra d'ombra /  
Umber /  
Terre d'ombre /  
Schattenland /  
Sombra  
*fin.sei*

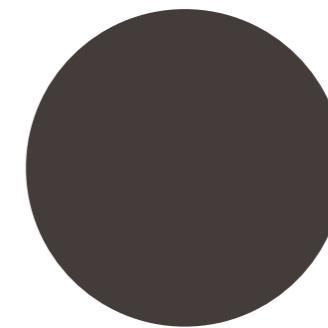

Arpa 526  
Grigio tempesta /  
Tempest grey /  
Gris tempête /  
Sturmgrau /  
Gris tempesta  
*fin.erre*

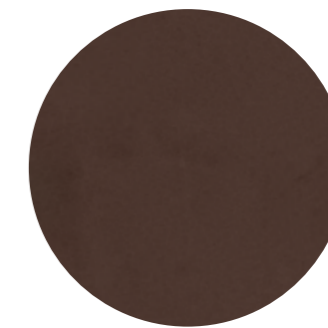

Abet 897  
Bruno vulcano /  
Volcano brown /  
Marrón volcán /  
Vulkan braun /  
Marron volcan  
*fin.sei*

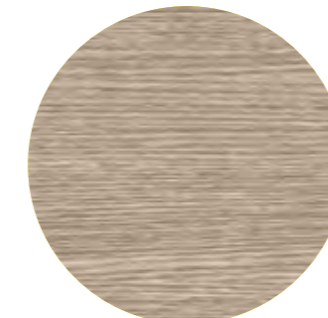

Abet 608  
Grigio cenere / Ash grey /  
Gris cendre / Aschgrau /  
Gris ceniza  
*fin.grainwood*



Arpa 4420  
Rovere allier / Allier oak /  
Chêne allier / Eiche Allier /  
Roble allier  
*fin.erre*

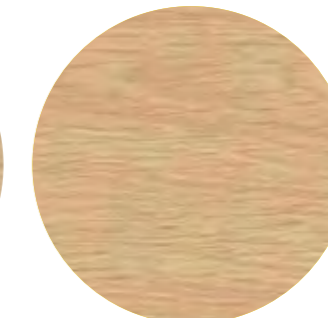

Abet 602  
Rovere boemia / Bohemia  
oak / Chêne bohème /  
Eiche Bohemia / Roble  
bohemia  
*fin.holz*



Abet 1394  
Olmo perlato / Pearl elm /  
Orme perlé / Perlulme /  
Olmo perlado  
*fin.root*



Abet 557  
Boiaccia grigio /  
Cement grey / Gris  
ciment / Zementgrau /  
Gris lechada  
*fin.papier*



Abet 545  
Vulcano / Volcano /  
Volcan / Vulkan /  
Volcán  
*fin.climb*



Abet 1455  
Ardesia / Slate /  
Ardoise / Schiefer /  
Pizarra  
*fin.climb*



Abet 546  
Tivoli / Tivoli /  
Tivoli / Tivoli /  
Tivoli  
*fin.climb*



Abet 1459  
Statuario / Statuario /  
Statuario / Bildhauerei /  
Statuario  
*fin.papier*



## cat. H

Antimpronta /  
Anti-fingerprints /  
Anti-empreinte /  
Anti Fingerabdrücke /  
Antihuella

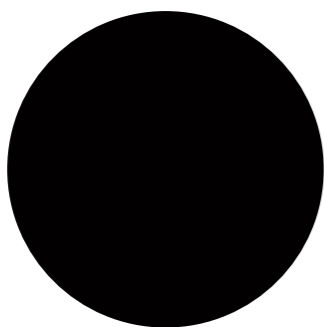

Fenix NTM 0720  
Nero ingo / Ingo black /  
Noir ingo / Schwarz ingo /  
Negro ingo

## harvey



Arpa 20  
Bianco / White /  
Blanc / Weiß /  
Blanco  
*fin.erre*

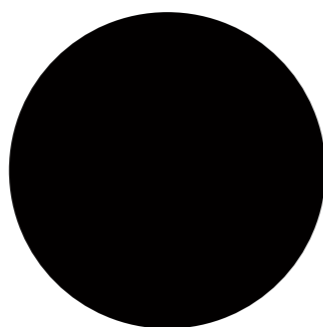

Fenix NTM 0720  
Nero ingo / Ingo black /  
Noir ingo / Schwarz ingo /  
Negro ingo

# uso e manutenzione - pulizia / use and maintenance - cleaning / utilisation et entretien - nettoyage / gebrauch und wartung - reinigung / uso y mantenimiento - limpieza

### Istruzioni generali per l'utilizzo dei prodotti Et al.

Al fine di garantire la durata nel tempo dei prodotti Et al., consigliamo di verificare periodicamente il corretto serraggio delle viti e di tenerli lontano da fonti di calore. Le sedute vanno utilizzate con le quattro gambe o la base appoggiata sul pavimento. Evitare di dondolarsi sulle gambe, salirvi in piedi, sedersi sullo schienale, sedersi sui braccioli e utilizzare il prodotto come scaletta. I tavoli vanno utilizzati con le quattro gambe o con la base appoggiata sul pavimento. Evitare di sedersi sui piani o salirvi in piedi. Alla fine del loro utilizzo i prodotti o i loro componenti non vanno dispersi nell'ambiente. Si consiglia di chiamare le aziende preposte allo smaltimento dei rifiuti per il loro trasporto in discarica. Et al. declina ogni responsabilità per danni derivanti da un uso improprio del prodotto.

### materiale plastico

#### PA (Poliammide)

Pulire il prodotto con un panno morbido e umido. Si consiglia l'utilizzo di detergenti neutri, meglio se diluiti in acqua. Non utilizzare detersivi abrasivi o che contengano, anche in minima quantità, alcool, trielina, ammoniaca e solventi in generale.

#### PE (Polietilene)

Pulire il prodotto con un panno morbido e umido. Si consiglia l'utilizzo di detergenti neutri, meglio se diluiti in acqua. Non utilizzare detersivi abrasivi o che contengano, anche in minima quantità, alcool, trielina, ammoniaca e solventi in generale. Il prodotto può essere lavato con dispositivi a pressione: tenere la punta del diffusore ad una distanza minima di 60cm dalla superficie del manufatto.

#### PP (Polipropilene)

Pulire il prodotto con un panno morbido e umido. Si consiglia l'utilizzo di detergenti neutri, meglio se diluiti in acqua. Non utilizzare detersivi abrasivi o che contengano, anche in minima quantità, alcool, trielina, ammoniaca e solventi in generale. Le scocche in PP sono trattate anti-UV. Il trattamento anti-UV è soggetto a un'usura che si accelera in caso di esposizione continua e prolungata alle intemperie e a forti sbalzi di temperatura. Per mantenere a lungo il prodotto in buone condizioni consigliamo di conservarli durante l'inverno in luoghi chiusi e asciutti e al riparo da forti sbalzi termici.

#### PP+PET

#### (Polipropilene + Polietilene tereftalato - Tecnopolimero composito multistrato a densità variabile)

Pulire il prodotto con un panno morbido e umido. Si consiglia l'utilizzo di detergenti neutri, meglio se diluiti in acqua. Non utilizzare detersivi abrasivi o che contengano, anche in minima quantità, alcool, trielina, ammoniaca e solventi in generale. Le scocche in PP+PET sono trattate anti-UV. Il trattamento anti-UV è soggetto a un'usura che si accelera in caso di esposizione continua e prolungata alle intemperie e a forti sbalzi di temperatura. Per mantenere a lungo il prodotto in buone condizioni consigliamo di conservarli durante l'inverno in luoghi chiusi e asciutti e al riparo da forti sbalzi termici.

#### XLP (Xiloplast)

Lavare il prodotto con acqua e detergente neutro incolore. Sciacquare con acqua a temperatura non superiore ai 30°C. Il prodotto può essere lavato con dispositivi a pressione: tenere la punta del diffusore ad una distanza minima di 60cm dalla superficie del manufatto.

### legno

#### Faggio - Frassino

Pulire il prodotto con un panno morbido e umido. Si consiglia l'utilizzo di detergenti neutri, meglio se diluiti in acqua. In seguito risciacquare con una spugna bagnata e asciugare con un panno asciutto.

#### Iroko

Trattandosi di materiale naturale, si potrebbero osservare variazioni di colore o anche crepe dovute al grado di umidità e ai bruschi cambiamenti di temperatura. Si consiglia, per conservare il prodotto, di applicare ogni 6 mesi un protettivo a base di olio biologico (es. LAYTECH LAB94149).

### rivestimenti

#### tessuto

*Fortis, Melva, Amsterdam, Medley, Mirage, Chili, Convert, In&Out, Rondo, Reviva, Fabthirty*  
Pulire il prodotto con un panno morbido e umido utilizzando detergente neutro.

#### Pelle e ecopelle

*Inca, Valencia, Ocean*  
Pulire il prodotto con una spugna inumidita in acqua tiepida e detergente neutro.

#### lana

*Fenice, Mood, Remix 3*  
Utilizzare smacchiatori a secco.

### metallo

#### AC VR - AC CR

#### (Acciaio Verniciato - Cromato)

Pulire il prodotto con un panno morbido e umido utilizzando detergente neutro. In caso i prodotti vengano usati all'esterno è fortemente consigliato il trattamento di zincatura o di cataforesi. Per mantenere a lungo il prodotto in buone condizioni consigliamo di conservarli durante l'inverno in luoghi chiusi e asciutti in modo da evitare le formazioni di condensa. Prima della stagione invernale e con cadenza trimestrale, se i prodotti sono conservati in prossimità del mare, si raccomanda di pulire le superfici di metallo con un panno morbido utilizzando acqua o detergenti e proteggerle con olio di vaselina.

#### AX

#### (Acciaio Inox: Satinato - Lucido)

Pulire il prodotto con un panno morbido ed umido utilizzando detergente neutro. Per proteggere il prodotto durante un eventuale stoccaggio si consiglia di stendere un velo di paraffina con l'utilizzo di un panno.

#### AL AND - AL PSH - AL VR

#### (Alluminio Anodizzato - Lucidato - Verniciato)

Pulire il prodotto con un panno morbido ed umido utilizzando detergente neutro.

### finiture piani tavoli

#### LAM (Laminato)

La superficie va pulita con regolarità attraverso un panno umido di acqua calda e detergenti delicati; sono ben tollerati quasi tutti i normali prodotti detergenti o disinfettanti domestici purché non siano abrasivi o alcalini.

#### STR (Stratificato HPL: Full Color - Compact)

La superficie va pulita con regolarità attraverso un panno umido di acqua

calda e detergenti delicati; sono ben tollerati quasi tutti i normali prodotti detergenti o disinfettanti domestici purché non siano abrasivi o alcalini.

### General instructions for the use of Et al. products

To ensure that Et al. products are long-lasting, we advise periodically checking that the screws are properly tightened and keeping them away from heat sources. The seats should be used with four legs or the base resting on the floor. Avoid rocking on the legs, standing on the chair, sitting on the backrest or the arms or using the product as a stepladder. The tables should be used with four legs or the base resting on the floor. Do not sit or stand on the table top. When no longer required, the products and their components must be disposed of responsibly. We recommend calling a waste disposal company to remove unwanted products and components. Et al. declines any responsibility for damages resulting from improper use of the products..

### plastic

#### PA (Polyamide)

Clean the product with a soft, damp cloth. We recommend using neutral detergents, preferably diluted in water. Do not use abrasive detergents or ones which contain even minimum quantities of alcohol, trichloroethylene, ammonia or solvents, in general.

#### PE (Polyethylene)

Clean the product with a soft, damp cloth. We recommend using neutral detergents, preferably diluted in water. Do not use abrasive detergents or ones which contain even minimum quantities of alcohol, trichloroethylene, ammonia or solvents, in general. The product can be washed with pressure devices: keep the nozzle at least 60 cm from the product surface.

#### PP (Polypropylene)

Clean the product with a soft, damp cloth. We recommend using neutral detergents, preferably diluted in water. Do not use abrasive detergents or ones which contain even minimum quantities of alcohol, trichloroethylene, ammonia or solvents, in general. The PP frames are anti-UV treated. The anti-UV treatment is subject

to more rapid wear in the event of continual and prolonged exposure to the elements and significant changes in temperature. To maintain the product in good condition for a long time, we recommend storage in closed and dry environments that are sheltered from significant differences in temperature during the winter.

**PP+PET (Polypropylene + Polyethylene terephthalate – multi-layer technopolymer composite with variable density)** Clean the product with a soft, damp cloth. We recommend using neutral detergents, preferably diluted in water. Do not use abrasive detergents or ones which contain even minimum quantities of alcohol, trichloroethylene, ammonia or solvents, in general. The PP+PET frames are anti-UV treated. The anti-UV treatment is subject to more rapid wear in the event of continual and prolonged exposure to the elements and significant changes in temperature. To maintain the product in good condition for a long time, we recommend storage in closed and dry environments that are sheltered from significant differences in temperature during the winter.

**XLP (Xiloplast)** Wash the product with water and colourless neutral detergent. Rinse with warm water that does not exceed 30°C. The product can be washed with pressure devices: keep the nozzle at least 60 cm from the product surface.

**wood**

**Beech – Ash** Clean the product with a soft, damp cloth. We recommend using neutral detergents, preferably diluted in water. Then, wipe down with a wet sponge and dry with a dry cloth.

**Iroko** Since this is a natural material, you may notice colour variations or cracks caused by humidity or sudden changes in temperature. To preserve the product, we recommend applying a protective layer of organic oil every six months (e.g. LAYTECH LAB94149).

**covering**

**fabric** *Fortis, Melva, Amsterdam, Medley, Mirage, Chili, Convert, In&Out, Rondo, Reviva, Fabthirty* Clean the product with a soft, damp cloth and a mild detergent.

**Leather, real leather and eco-leather** *Inca, Valencia, Ocean, real leather* Clean the product with a sponge, warm water and a mild detergent.

**wool** *Fenice, Mood, Remix 3* Use a dry stain remover.

**metal**

**AC VR – AC CR (Painted – Chrome-plated)** Clean the product with a soft, damp cloth and a neutral detergent. In the event of product use outdoors, we highly recommend zinc-coating or cataphoresis treatments. To maintain the product in good condition for a long time, we recommend storage in closed and dry environments in order to avoid condensation. If the products are used or stored in seaside environments, before the winter season and every three months, we recommend cleaning the metal surfaces, with a soft cloth using water or detergents, and applying Vaseline oil.

**AX (Stainless Steel: Satin-finish – Polished)** Clean the product with a soft, damp cloth, using a neutral detergent. We recommend using a cloth to apply a thin layer of paraffin to protect the product when stored.

**AL AND – AL PSH – AL VR (Anodized – Polished Painted aluminium)** Clean the product with a soft, damp cloth, using a neutral detergent.

**table top finishes**

**LAM (Laminated)** The surface should be cleaned regularly with a warm, damp cloth and mild detergents; Most standard detergents or household disinfectants can be used provided they are not abrasive or alkaline.

**STR (HPL Solid Laminate: Full color – Compact)** The surface should be cleaned regularly with a warm, damp cloth and mild detergents. Most standard detergents or household disinfectants can be used provided they are not abrasive or alkaline.

**Instructions générales pour l'utilisation des produits Et al.**

Afin de garantir une longue durée de vie aux produits Et al., nous conseillons de vérifier régulièrement que les vis sont bien serrées et que les produits sont utilisés loin de sources de chaleur. Les chaises doivent être utilisées avec les quatre pieds ou le socle posé au sol. Éviter de se balancer en soulevant les pieds de la chaise, de se mettre debout sur l'assise, de s'asseoir sur le dossier ou sur les accoudoirs. Les tables doivent être utilisées avec les quatre pieds ou le socle posé au sol. Éviter de s'asseoir ou de se mettre debout sur le plateau. À la fin de leur vie utile, les produits et leurs composants doivent être éliminés dans le respect de l'environnement. Il est conseillé de contacter une entreprise préposée au traitement des déchets pour leur transport en décharge. Et al.

décline toute responsabilité pour les dommages résultant d'une mauvaise utilisation du produit.

**matière plastique**

**PA (Polyamide)** Nettoyer le produit avec un chiffon doux et humide. Il est conseillé d'utiliser des détergents neutres, de préférence dilués dans de l'eau. Ne pas utiliser de détergents abrasifs ou qui contiennent de l'alcool, du trichloréthylène, de l'ammoniaque et tout solvant, même en quantité très réduite.

**PE (Polyéthylène)** Nettoyer le produit avec un chiffon doux et humide. Il est conseillé d'utiliser des détergents neutres, de préférence dilués dans de l'eau. Ne pas utiliser de détergents abrasifs ou qui contiennent de l'alcool, du trichloréthylène, de l'ammoniaque et tout solvant, même en quantité très réduite. Le produit peut être lavé avec des appareils de nettoyage sous pression : garder la pointe du diffuseur à une distance minimum de 60 cm de la surface du meuble.

**PP (Polypropylène)** Nettoyer le produit avec un chiffon doux et humide. Il est conseillé d'utiliser des détergents neutres, de préférence dilués dans de l'eau. Ne pas utiliser de détergents abrasifs ou qui contiennent de l'alcool, du trichloréthylène, de l'ammoniaque et tout solvant, même en quantité très réduite. Les coques en PP sont traitées anti-UV. Le traitement anti-UV est sujet à une usure plus rapide en cas d'exposition continue et prolongée aux intempéries et aux brusques variations de température. Pour garantir durablement le bon état du produit, en hiver, il est recommandé de le conserver dans un lieu clos, à l'abri de l'humidité et des brusques variations de température.

**PP+PET (Polypropylène + Polyéthylène téréphtalate - Technopolymère composite multicouche à densité variable)** Nettoyer le produit avec un chiffon doux et humide. Il est conseillé d'utiliser des détergents neutres, de préférence dilués dans de l'eau. Ne pas utiliser de détergents abrasifs ou qui contiennent de l'alcool, du trichloréthylène, de l'ammoniaque et tout solvant, même en quantité très réduite. Les coques en PP+PET sont traitées anti-UV. Le traitement anti-UV est sujet à une usure plus rapide en cas d'exposition continue et prolongée aux intempéries et aux brusques variations de température. Pour garantir durablement le bon état du produit, en hiver, il est recommandé de le conserver dans un lieu clos, à l'abri de l'humidité et des brusques variations de température.

**XLP (Xiloplast)** Laver le meuble avec de l'eau et du détergent neutre incolore. Rincer avec de l'eau à une température ne dépassant pas les 30°C. Le produit peut être lavé avec des dispositifs de nettoyage sous pression : garder la pointe du diffuseur à une distance minimum de 60 cm de la surface du meuble.

**bois**

**Hêtre – Frêne** Nettoyer le produit avec un chiffon doux et humide. Il est conseillé d'utiliser des détergents neutres, de préférence dilués dans de l'eau. Rincer ensuite avec une éponge mouillée et essuyer avec un chiffon sec.

**Iroko** S'agissant d'une matière naturelle, il est possible d'observer des variations de couleur ainsi que des fissures dues au degré d'humidité et aux changements brusques de température. Pour mieux conserver le meuble, il est conseillé d'appliquer un produit protecteur à base d'huile biologique (par ex. LAYTECH LAB94149) tous les 6 mois.

**revêtements**

**tissu** *Fortis, Melva, Amsterdam, Medley, Mirage, Chili, Convert, In&Out, Rondo, Reviva, Fabthirty* Nettoyer le produit avec un chiffon doux et humide en utilisant un détergent neutre.

**peau, cuir naturel and simili-cuir** *Inca, Valencia, Ocean, cuir naturel* Nettoyer le produit avec une éponge humidifiée avec de l'eau tiède et un détergent neutre.

**laines** *Fenice, Mood, Remix 3* Utiliser un détachant à sec.

**métaux**

**AC VR – AC CR (Acier verni – Chromé)** Nettoyer le produit avec un chiffon doux et humide en utilisant un détergent neutre. Dans le cas où les produits seraient utilisés en extérieur, le traitement de zincage ou de cataphorèse est vivement recommandé. Pour garantir durablement le bon état du produit, en hiver, il est recommandé de le conserver dans un lieu clos et à l'abri de l'humidité pour prévenir la formation de condensation. Avant les mois d'hiver et tous les trois mois si les produits sont utilisés à proximité de la mer, il est recommandé de nettoyer les surfaces métalliques à l'aide d'un chiffon doux, en utilisant de l'eau ou un détergent, et de les protéger à l'aide d'huile de vaseline.

**AX (Acier Inox : Satiné – Brillant)** Nettoyer le produit avec un chiffon doux et humide en utilisant un détergent neutre. Pour protéger le produit pendant un éventuel stockage, il est conseillé appliquer une couche de paraffine avec un chiffon.

**AL AND – AL PSH – AL VR (Aluminium anodisé – Brillant – Verni)** Nettoyer le produit avec un chiffon doux et humide en utilisant un détergent neutre.

**finitions plateaux des tables**

**LAM (Stratifié)** Nettoyer régulièrement la surface avec un chiffon humidifié avec de l'eau chaude et des détergents délicats ; pratiquement tous les produits détergents et désinfectants domestiques courants sont bien tolérés à condition qu'ils ne soient pas abrasifs ou alcalins.

**STR (Stratifié HPL : Full color – Compact)** Nettoyer régulièrement la surface avec un chiffon humidifié avec de l'eau chaude et des détergents délicats ; pratiquement tous les produits détergents et désinfectants domestiques courants sont bien tolérés à condition qu'ils ne soient pas abrasifs ou alcalins.

**wood**

**Allgemeine hinweise zur verwendung der produkte von Et al.** Um eine lange Haltbarkeit der Produkte von Et al. zu garantieren, empfehlen wir regelmäßig zu überprüfen, ob die Schrauben korrekt eingeschraubt sind und von Wärmequellen fernhalten. Sitzmöbel sind so zu verwenden, dass die vier Beine oder das Gestell auf dem Boden aufliegen. Das Schaukeln auf den Beinen, das Stehen auf den Sitzmöbeln, das Sitzen auf der Rückenlehne oder den Armlehnen und das Verwenden des Artikels als Steighilfe ist zu unterlassen. Die Tische sind so zu verwenden, dass die vier Beine oder das Gestell auf dem Boden aufliegen. Das Sitzen oder Stehen auf der Tischplatte ist zu unterlassen. Am Ende der Lebensdauer dürfen die Produkte oder ihre Bestandteile nicht in der Umwelt entsorgt werden. Kontaktieren Sie ein Entsorgungsunternehmen und organisieren Sie den Transport der Einrichtungsgegenstände zur Abfallsammelstelle. Et al. übernimmt keine Haftung für Schäden, die durch unsachgemäße Verwendung des Produkts entstehen.

**Kunststoff**

**PA (Polyamid)** Das Produkt mit einem weichen und feuchten Tuch reinigen. Die Verwendung neutraler Reinigungsmittel, die mit Wasser verdünnt werden, wird empfohlen. Keine abrasiven Reinigungsmittel oder Reinigungsmittel, die – wenn auch nur in minimalen Mengen - Alkohol, Trichlorethylen, Ammoniak oder Lösungsmittel im Allgemeinen enthalten, verwenden. Rahmen aus PP+PET mit UV-Schutzbeschichtung Die UV-Schutzbeschichtung nutzt sich im Verlauf der Zeit ab. Diese Abnutzung wird beschleunigt, wenn die Produkte über längere Zeit dauerhaft der Witterung und starken Temperaturschwankungen ausgesetzt sind. Um die Produkte möglichst lange in einwandfreiem Zustand zu erhalten, empfehlen wir, sie während des Winters an einem geschlossenen, trockenen Ort aufzubewahren.

**Leder, Natur Leder und Kunstleder** *Inca, Valencia, Ocean, Natur Leder* Das Produkt mit einem mit lauwarmem Wasser und neutralem Reinigungsmittel getränktem Schwamm reinigen.

verdünnt werden, wird empfohlen. Keine abrasiven Reinigungsmittel oder Reinigungsmittel, die – wenn auch nur in minimalen Mengen - Alkohol, Trichlorethylen, Ammoniak oder Lösungsmittel im Allgemeinen enthalten, verwenden.

**PE (Polyäthylen)** Das Produkt mit einem weichen und feuchten Tuch reinigen. Die Verwendung neutraler Reinigungsmittel, die mit Wasser verdünnt werden, wird empfohlen. Keine abrasiven Reinigungsmittel oder Reinigungsmittel, die – wenn auch nur in minimalen Mengen - Alkohol, Trichlorethylen, Ammoniak oder Lösungsmittel im Allgemeinen enthalten, verwenden. Das Produkt kann mit Geräten, die unter Druck stehen, gereinigt werden: Halten Sie die Spitze des Diffusors mindestens 60 cm von der Produktoberfläche entfernt.

**PP (Polypropylen)** Das Produkt mit einem weichen und feuchten Tuch reinigen. Die Verwendung neutraler Reinigungsmittel, die mit Wasser verdünnt werden, wird empfohlen. Keine abrasiven Reinigungsmittel oder Reinigungsmittel, die – wenn auch nur in minimalen Mengen - Alkohol, Trichlorethylen, Ammoniak oder Lösungsmittel im Allgemeinen enthalten, verwenden. Rahmen aus PP mit UV-Schutzbeschichtung Die UV-Schutzbeschichtung nutzt sich im Verlauf der Zeit ab. Diese Abnutzung wird beschleunigt, wenn die Produkte über längere Zeit dauerhaft der Witterung und starken Temperaturschwankungen ausgesetzt sind. Um die Produkte möglichst lange in einwandfreiem Zustand zu erhalten, empfehlen wir, sie während des Winters an einem geschlossenen, trockenen Ort und vor starken Temperaturschwankungen geschützt aufzubewahren.

**PP+PET (Polypropylen + Polyethylen – Terephthalat – Mehrschicht-Technopolymer-Verbund mit variabler Dichte)** Das Produkt mit einem weichen und feuchten Tuch reinigen. Die Verwendung neutraler Reinigungsmittel, die mit Wasser verdünnt werden, wird empfohlen. Keine abrasiven Reinigungsmittel oder Reinigungsmittel, die – wenn auch nur in minimalen Mengen - Alkohol, Trichlorethylen, Ammoniak oder Lösungsmittel im Allgemeinen enthalten, verwenden. Rahmen aus PP+PET mit UV-Schutzbeschichtung Die UV-Schutzbeschichtung nutzt sich im Verlauf der Zeit ab. Diese Abnutzung wird beschleunigt, wenn die Produkte über längere Zeit dauerhaft der Witterung und starken Temperaturschwankungen ausgesetzt sind. Um die Produkte möglichst lange in einwandfreiem Zustand zu erhalten, empfehlen wir, dem Winter und alle drei Monate die Metallflächen mit einem weichen Tuch, getränkt mit Wasser oder

**XLP (Xiloplast)** Das Produkt mit Wasser und einem neutralen, farblosen Reinigungsmittel reinigen. Mit Wasser mit einer maximalen Temperatur von 30 °C abspülen. Das Produkt kann mit Geräten, die unter Druck stehen, gereinigt werden: Halten Sie die Spitze des Diffusors mindestens 60 cm von der Produktoberfläche entfernt.

**Holz**

**Buche – Esche** Dazu sollten neutrale, mit Wasser verdünnte Reinigungsmittel verwendet werden. Die Verwendung neutraler Reinigungsmittel, die mit Wasser verdünnt werden, wird empfohlen. Anschließend mit einem nassen Schwamm abwischen und mit einem trockenen Tuch nachtrocknen.

**Iroko** Da es sich hierbei um ein natürliches Material handelt, kann es zu Veränderungen in der Farbe oder auch zu Rissen kommen, die auf den Feuchtigkeitsgrad und auf plötzliche Temperaturveränderungen zurückzuführen sind. Um den einwandfreien Zustand des Produkts zu erhalten, sollte alle 6 Monate ein Schutz auf Bioölbasis aufgetragen werden (z.B. LAYTECH LAB94149).

**Bezüge**

**Stoffe** *Fortis, Melva, Amsterdam, Medley, Mirage, Chili, Convert, In&Out, Rondo, Reviva, Fabthirty* Das Produkt mit einem weichen und feuchten Tuch reinigen und dabei ein neutrales Reinigungsmittel verwenden.

**Leder, Natur Leder und Kunstleder** *Inca, Valencia, Ocean, Natur Leder* Das Produkt mit einem mit lauwarmem Wasser und neutralem Reinigungsmittel getränktem Schwamm reinigen.

**Wolle** *Fenice, Mood, Remix 3* Trockene Fleckentferner verwenden.

**metall**

**AC VR – AC CR (Stahl: Lackiert – Verchromt)** Das Produkt mit einem weichen und feuchten Tuch reinigen und dabei ein neutrales Reinigungsmittel verwenden. Bei Verwendung im Freien wird dringend eine Oberflächenbehandlung wie Verzinkung oder Kataphorese empfohlen. Um die Produkte möglichst lange in einwandfreiem Zustand zu erhalten, empfehlen wir, sie während des Winters an einem geschlossenen, trockenen Ort aufzubewahren, um Kondenswasserbildung zu vermeiden. Bei Einlagerung der Produkte in Küstennähe empfehlen wir, vor dem Winter und alle drei Monate die Metallflächen mit einem weichen Tuch, getränkt mit Wasser oder

einem Reinigungsmittel, zu säubern und anschließend mit Vaselineöl zu schützen.

**AX (Edelstahl: Matt – Poliert)** Das Produkt mit einem weichen und feuchten Tuch reinigen und dabei ein neutrales Reinigungsmittel verwenden. Um das Produkt während einer eventuellen Lagerung zu schützen, sollte mit einem Tuch eine Paraffinschicht aufgetragen werden.

**AL AND – AL PSH – AL VR (Aluminium eloxiert – poliert – lackiert)** Das Produkt mit einem weichen und feuchten Tuch reinigen und dabei ein neutrales Reinigungsmittel verwenden.

**Oberflächen von Tischplatten**

**LAM (Laminat)** Die Oberfläche regelmäßig mit einem mit warmem Wasser und mildem Reinigungsmittel getränkten Tuch säubern; hierzu eignen sich die meisten der handelsüblichen Reinigungs- und Desinfektionsmittel, sofern sie weder abrasiv noch alkalisch sind.

**STR (HPL Compact Platte: Full color – Compact)** Die Oberfläche regelmäßig mit einem mit warmem Wasser und mildem Reinigungsmittel getränkten Tuch säubern; hierzu eignen sich die meisten der handelsüblichen Reinigungs- und Desinfektionsmittel, sofern sie weder abrasiv noch alkalisch sind.

**wood**

**Instrucciones generales para el uso de los productos Et al.** Para garantizar la duración en el tiempo de los productos Et al., recomendamos controlar periódicamente el ajuste correcto de los tornillos y mantenerlos alejados de fuentes de calor. Los asientos deben utilizarse con las cuatro patas o la base apoyada en el suelo. Evitar balancearse con las patas, ponerse de pie sobre ellos, sentarse en el respaldo, sentarse en los apoyabrazos y utilizar el producto como escalera. Las mesas se deben utilizar con las cuatro patas o con la base apoyada en el suelo. Evitar sentarse en los sobros o ponerse de pie sobre ellos. Al final de su uso, los productos y sus componentes no se deben dispersar en el medio ambiente. Se recomienda comunicarse con las empresas encargadas de la eliminación de los residuos para su transporte al vertedero. Et al. declina cualquier responsabilidad por los daños que puedan resultar del uso inadecuado del producto.



# legenda / index / légende / zeichenerklärung / leyenda

## material plástico

### PA (Poliamida)

Limpiar el producto con un paño suave y húmedo. Se recomienda el uso de detergentes neutros, preferiblemente diluidos en agua. No utilizar detergentes abrasivos o que contengan, aunque sea en una cantidad mínima, alcohol, tricloroetileno, amoniaco y disolventes en general.

### PE (Polietileno)

Limpiar el producto con un paño suave y húmedo. Se recomienda el uso de detergentes neutros, preferiblemente diluidos en agua. No utilizar detergentes abrasivos o que contengan, aunque sea en una cantidad mínima, alcohol, tricloroetileno, amoniaco y disolventes en general. El producto se puede lavar con dispositivos a presión: mantener la punta del difusor a una distancia mínima de 60 cm de la superficie del producto.

### PP (Polipropileno)

Limpiar el producto con un paño suave y húmedo. Se recomienda el uso de detergentes neutros, preferiblemente diluidos en agua. No utilizar detergentes abrasivos o que contengan, aunque sea en una cantidad mínima, alcohol, tricloroetileno, amoniaco y disolventes en general. Las carcasas en PP están tratadas anti-UV. El tratamiento anti-UV está sujeto a un desgaste que se acelera en caso de exposición continua y prolongada al mal tiempo y a cambios fuertes de temperatura. Para mantener el producto en buenas condiciones por mucho tiempo, le recomendamos que se mantengan en lugares cerrados y secos durante el invierno y alejado de los cambios fuertes de temperatura.

### PP+PET (Polipropileno + Polietileno tereftalato - Tecnopolímero compuesto multicapa de densidad variable)

Limpiar el producto con un paño suave y húmedo. Se recomienda el uso de detergentes neutros, preferiblemente diluidos en agua. No utilizar detergentes abrasivos o que contengan, aunque sea en una cantidad mínima, alcohol, tricloroetileno, amoniaco y disolventes en general. Las carcasas en PP + PET están tratadas anti-UV. El tratamiento anti-UV está sujeto a un desgaste que se acelera en caso de exposición continua y prolongada al mal tiempo y a cambios fuertes de temperatura. Para mantener el producto en buenas condiciones por mucho tiempo, le recomendamos que se mantengan en lugares cerrados y secos durante el invierno y alejado de los cambios fuertes de temperatura.

### XLP (Xiloplast)

Lavar el producto con agua y detergente neutro incoloro. Enjuagar con agua a temperatura no superior de 30 °C. El producto se puede lavar con dispositivos a presión: mantener la punta del difusor a una distancia mínima de 60 cm de la superficie del producto.

## madera

### Haya – Fresno

Limpiar el producto con un paño suave y húmedo. Se recomienda el uso de detergentes neutros, preferiblemente diluidos en agua. Después enjuagar con una esponja mojada y secar con un paño seco.

### Iroko

Al tratarse de un material natural, podrían presentarse variaciones de color o grietas debidas al grado de humedad y a los bruscos cambios de temperatura. Para conservar el producto, se recomienda aplicar cada 6 meses un protector a base de aceite biológico (p. ej. LAYTECH LAB94149).

## revestimientos

### tejido

*Fortis, Melva, Amsterdam, Medley, Mirage, Chili, Convert, In&Out, Rondo, Reviva, Fabthirty* Limpiar el producto con un paño suave y húmedo usando detergente neutro.

### piel, cuero y cuero ecológico

*Inca, Valencia, Ocean, cuero* Limpiar el producto con una esponja embebida en agua tibia y detergente neutro.

### lanas

*Fenice, Mood, Remix 3* Utilizar quitamanchas en seco.

## Metal

### AC VR – AC CR –

#### (Acero Barnizado – Cromado)

Limpiar el producto con un paño suave y húmedo usando detergente neutro.

Si los productos se utilizan en el exterior, es muy recomendable el tratamiento de galvanización o cataforesis. Para mantener el producto en buenas condiciones por mucho tiempo, recomendamos mantenerlo en lugares cerrados y secos durante el invierno para evitar la condensación. Antes de la temporada del invierno y trimestralmente, si los productos están cerca del mar, se recomienda limpiar las superficies en metal con un paño suave con agua o detergentes y protegerlos con aceite de vaselina.

### AX (Acero inoxidable: satinado – pulido)

Limpiar el producto con un paño suave y húmedo usando detergente neutro. Para proteger el producto durante el almacenamiento se recomienda aplicar una fina capa de parafina utilizando un paño.

### AL AND – AL PSH – AL VR (Aluminio anodizado – pulido – barnizado)

Limpiar el producto con un paño suave y húmedo usando detergente neutro.

## acabados de sobres de mesa

### LAM (Laminado)

La superficie se debe limpiar regularmente con un paño humedecido en agua caliente y detergente suave; se toleran bien casi todos los detergentes o desinfectantes domésticos habituales, siempre que no sean abrasivos o alcalinos.

### STR

#### (Estratificado HPL: Full color – Compact)

La superficie se debe limpiar regularmente con un paño humedecido en agua caliente y detergente suave; se toleran bien casi todos los detergentes o desinfectantes domésticos habituales, siempre que no sean abrasivos o alcalinos.



Per esterni nelle finiture idonee / For outdoor use, in the suitable finishes / Pour l'extérieur, dans certaines finitions / Für aussen, in den geeigneten Ausführungen / Para utilización ex exteriores, en los acabados adecuados



Resistente a salsedine, cloro e acque termali nelle finiture idonee / Resistant to salty environments, chlorine and thermal waters - in the suitable finishes / Résistant à la salinité, chlore et eaux thermales, dans certaines finitions / Beständig gegen salzhaltige Umgebung, Chlor und Thermalwasser, in den geeigneten Ausführungen / Resistente a la salinidad, cloro y aguas termales, en los acabados adecuados



Meccanismo di ritorno / Kick-back device / Mechanisme de retour / Automatischer zurück Systeme / Sistema de vuelta



Riciclato / Recycled / Recyclé/ Recycelt / Reciclado



Riciclabile / Recyclable / Recyclable / Recycling / Reciclable



Girevole / Swivelling / Pivotant / Drehbar / Giratorio

## AC

Acciaio / Steel / Acier / Stahl / Acero

## AL

Alluminio / Aluminium / Aluminium / Aluminium / Aluminio

## AL AND

Alluminio Anodizzato / Anodized Aluminium / Aluminium Anodisé / Eloxiertes Aluminium / Aluminio Anodizado

## AL PSH

Alluminio Lucidato / Polished Aluminium / Aluminium Brilliant Poliertes Aluminium / Aluminio Pulido

## AL VR

Alluminio Verniciato/ Painted aluminium / Aluminium verni / Lackiert Aluminium / Aluminio barnizado

## AX

Acciaio Inox / Stainless Steel / Acier Inoxydable / Edelstahl / Acero Inoxidable

## CO

Cotone / Cotton / Coton / Baumwolle / Algodón

## COM

Tessuto fornito dal cliente / Customer own material / Tissu client / Kundenstoff / Tela cliente

## CR

Cromato / Chrome / Chromé / Verchromt / Cromado

## F.R. foam

Gomma con elevata resistenza al fuoco – verificare con il commerciale le normative di riferimento / Fire retardant foam – please refer to customer service for specific certifications / Mousse Non-Feu – verifier avec le bureau commerciale les règlements non-feu / Schaumstoff Schwerentflammbarer – Überprüfen Sie bitte die Bezugsvorschriften mit der Handelsabteilung / Espuma anti-fuego – favor contactar dpto. commercial para certificaciones específicas

## LAM

Laminato / Laminate / Stratifié / Laminat / Laminado

## LE

Legno / Wood / Bois / Holz / Madera

## NY

Nylon / Nylon / Nylon / Nylon / Nylon

## PA

Poliammide / Polyamide / Polyamide / Polyamid / Poliamida

## PE

Polietilene / Polyethylene / Polyéthylène / Polyäthylene / Polietileno

## PET

Polietilene tereftalato / Terephthalate polyethylene / Polyéthylène téréphtalate / Polyäthylenterephthalat / Polietileno tereftalato

## PL

Poliestere / Polyester / Polyester / Polyester / Poliéster

## PP

Polipropilene / Polypropylene / Polypropylène / Polypropylen / Polipropileno /

## PP + PET

Tecnopolímero composito multistrato a densità variabile (polipropilene + polietilene tereftalato) / Multi-layer variable density man-made Composite polymer (polypropylene + Terephthalate polyethylene) / Techno-polymère composite multicouche à densité variable (polypropylène + Polyéthylène téréphtalate) / Zusammengesetztes mehrschichtiges Technopolymere mit wechselbarer dichte (Polypropylen + Polyäthylenterephthalat) / Tecnopolímero compuesto multicapas de densidad variable (polipropileno + Polietileno tereftalato)

## STR

Stratificato HPL / HPL Solid Laminate / Stratifié HPL / HPL Compactplatte / Estratificado HPL

## TE

Tessuto / Fabric / Tissu / Stoff / Tejido

## VR

Verniciato / Paint Finishing / Verni / Lackiert / Barnizado

## WO

Lana / Wool / Laine / Wolle / Lana

## XLP

Xiloplast / Xiloplast / Xiloplast / Xiloplast / Xiloplast



Art direction  
and graphic design  
**Leonardo Sonnoli**  
**Irene Bacchi**  
con **Veronica Gardinali**  
– **Studio Sonnoli** –

Foto / Photo  
**Amati-Bacciardi**  
**Massimo Gardone**  
**Alberto Chiariglione**  
**Guðmann Þór Bjargmundsson**  
**Matroskin Photography**  
**Kris Thijs**  
**Sergey Zhabskiy**  
in **Him's**

Crediti / Credits  
**Antonio Bachour**  
**Arch. Aloï Natale Fabio**  
**Atalaya Jávea**  
**Fondazione Piccolo Teatro**  
**di Milano - Teatro d'Europa**  
**Harpa Lind**  
**ifi contract**  
in **Him's**  
**JK Lab Architects**  
**Marazzi Ceramiche,**  
**Stand Cersaie 2018, Ph. Op-Fot.**  
**motif design**  
**Norén Concept**  
**Serist srl**  
**S.I.D. interior**  
**velvetLAB**  
**Wisp Architects**

Carattere / Font  
**Founders Grotesk**

Carta / Paper  
**Sappi Magno Matt 150 gr**

Prestampa / Pre-press  
**Olimpia Visual plan**

Stampa/Printing  
**Grafiche Antiga**

Tutte le dimensioni, pesi, caratteristiche  
e colori dei prodotti pubblicati sono  
puramente indicativi. / All dimensions,  
weights, characteristics and colours of the  
products listed are purely indicative.

I colori reali possono variare rispetto ai  
riferimenti cromatici forniti a causa delle  
inevitabili differenze tra i materiali utilizzati  
e la riproduzione tipografica. Si prega di  
contattare l'ufficio commerciale prima  
dell'ordine per informazioni aggiornate. /  
Actual colours can be different than those  
indicated in the finishes section due to the  
inevitable differences between the material  
used and the typographical reproduction.  
You are kindly invited to contact the sales  
department for further information before  
placing your order.

Et al. si riserva il diritto di apportare  
modifiche e/o migliorie di carattere tecnico  
ed estetico ai propri prodotti in qualsiasi  
momento e senza obbligo di preavviso. /  
Et al. reserves the right to make  
modifications and/or improvements of  
technical and aesthetical nature to its  
products at any time and without prior  
notice.

Per certificazioni prodotti vedi /  
For products certifications see

[www.et-al.it](http://www.et-al.it)

**Et al.**  
è una divisione di  
is a division of



**IFI S.p.A.**  
Strada Selva Grossa, 28/30  
61010 Tavullia (PU) – Italy

©Copyright IFI S.p.A.  
Tavullia (PU) - Italia, 04/2021

Tutti i diritti riservati  
All rights reserved

I prodotti possono essere  
tutelati da brevetto e/o da design  
Products may be protected  
by patent and/or design



**Et al.**  
Strada Selva Grossa, 28/30  
61010 Tavullia (PU) - Italy  
[www.et-al.it](http://www.et-al.it)

Italia  
T +39 0721 203607  
[commerciale@et-al.it](mailto:commerciale@et-al.it)

Export  
T +39 0721 203601  
[export@et-al.it](mailto:export@et-al.it)

follow us



